



2017 Price List

Effective January 1, 2017

Please refer to our online price book at www.9to5seating.com/downloads for the latest changes including product drops and additions.

table of contents

INFORMATION

2	about 9to5 Seating
4	green practice
8	lifetime warranty
10	general information
12	condition of sale
13	dimensions / lead time
14	order procedure
15	packaging codes / upholstery selection
16	fabric program
28	customer material program
30	CAL TB 133 fire code
31	two tone option
32	custom embroidery submission form

SEATING PRODUCTS

34	new for 2017!
36	acclaim: 2780
38	agent: 1425, 1426, 1428, 1660, 1666, 1668
50	aria: 1860, 1866, 1868, 1880, 1885
54	axis: 2600, 2610
58	bella: 1310, 1315, 1320, 1325, 1326, 1328, 1360, 1365, 1370, 1375, 1376, 1378
82	brio: 2060, 2066, 2068, 2070, 2076, 2078
86	bristol: 2360, 2366, 2368, 2380
92	cayman: 2800, 2810
96	core: 2260
98	cortina: 2900, 2910
102	cosmo: 3250, 3260, 3200, 3210, 3220, 3230
108	cydia: 3300, 3306, 3308, 3310, 3315, 3316
122	diddy: 2450
124	enduro: 1960, 1966, 1968, 1980
128	indy: 1010, 1020
134	kelley: 1060, 1066, 1070, 1076
138	link: 1410, 1415
144	logic: 1760, 1766, 1768, 1780
152	precept: 1725, 1726, 1728
158	shuttle: 1210, 1215, 1230, 1250, 1260, 1265, 1280
182	sophie: 8111, 8112, 8113, 8118, 8122, 8123, 8102, 8103, 8104
192	strata: 1545, 1546, 1548, 1555, 1560, 1566, 1568, 1580
198	strata Mesh: 1535, 1536, 1537, 1538, 1570, 1576, 1578, 1590
202	theory: 2160, 2166, 2168, 2170, 2176, 2178, 2180, 2190
214	vault: 1460, 1466, 1468, 1480
220	vesta: 3060, 3061, 3063, 3065, 3066, 3068, 3080, 3085
224	zoom: 1115, 1125, 1126, 1128
230	@NCE: 50B, 103S, 176, 203, 216, 217

ACCESSORIES

232	arm guide
234	caster guide
236	glide guide
237	cylinder guide
238	accessories
242	control selection guide
244	BIFMA ultimate test for fit (UTFF)
245	care and maintenance instructions
246	notes

about 9to5 Seating

Mission

Founded in 1982, 9to5 Seating specializes in the design and production of ergonomic and aesthetically pleasing office seating to accommodate the rigorous demands of today's office environment. With many years of experience in the manufacturing of office seating, 9to5 Seating differentiates itself from its competitors through its vertical integration. The combination of domestic and foreign manufacturing, with wholly owned facilities in the United States and China, offers the customer a wide variety of upholstery material only when manufactured in the United States, allowing 9to5 Seating to compete with prices of completely foreign manufactured products.

Unlike many competing companies, the vertical integration of 9to5 Seating paired with the highest quality raw materials and state of the art manufacturing equipment results in 9to5 Seating building with quality rather than checking for quality.

In a major reshoring effort to bring manufacturing jobs back to the United States, 9to5 Seating recently opened its 3rd manufacturing facility in Union City, Tenn. The knowhow and the hard work ethic of the American work force brings the products closer to their point of use in the United States and can rival the competition imported from overseas.

Companies today demand the most for their money and 9to5 Seating is prepared to deliver the highest quality product without sacrificing selection or speed of delivery.

Below are some highlights of the program:

- **Lead Time:** 5 Business Day Quick Ship and Standard 15 Day Lead time
- **Textiles:** Choose from thousands of commercial grade designer textiles from Architex, Arcom, CF Stinson, Designtex, Lindsey & Hall, Maharam, Mayer, and Momentum Textiles
- **Leather:** Select from a wide range of leather colors including 10 colors in leather/vinyl combinations
- **Lifetime Manufacturer's Warranty**
- **Premium Quality Components**
 - Nylon Bases are made from 100% virgin glass reinforced nylon
 - All task, executive, and conference seating incorporate molded foam cushions

Supply Chain Innovation

Due to our vertical integration, 9to5 Seating has achieved efficiencies not found in the operations of other manufacturers. Our investment in facilities capable of producing chair components provides a cost advantage for our company on every chair we produce. Additionally our independence from third-party manufacturers allows 9to5 Seating to better control quality, lead time, and consistency. Traditionally, chair manufacturers have been forced to buy components at prices that support the overhead of the component manufacturer. 9to5 Seating's innovative supply chain has effectively eliminated this unnecessary overhead resulting in the extraordinary value found in our product.

Business Practices

It is an integral part of our corporate philosophy to promote environmental preservation. This ideology drives our endless commitment to a sustainable future.

9to5 Seating incorporates the following practices into our business functions:

- Compact and recycle 100% of inbound carton packaging material, protecting landfills from over 25 tons of cardboard every month!
- Assembled a national network of blanket wrap carriers to allow orders to ship without cartons.
- Produce all outbound cartons from recycled corrugated cardboard.
- Ship with blanket wrap carriers whenever possible to eliminate cardboard debris.
- Use of electric forklifts in lieu of propane or other fuel based vehicles.
- Recycle all paper cans and plastic bottles from daily office activities.
- Dispose of used computer equipment and machine oil through proper channels.
- Return empty photocopier/printer cartridges to our supplier for refilling.
- Utilize paperless systems for internal reporting and production/warehouse management.
- Specify recycled paper for all printed literature pieces.
- Rooftop photo voltaic panel system offsets 5,164,303 pounds of CO2 over its lifetime of 25 years, equivalent to the amount of CO2 emitted by driving 157,278 cars 50 miles a day for one year.

Traditional Supply Chain For Office Seating

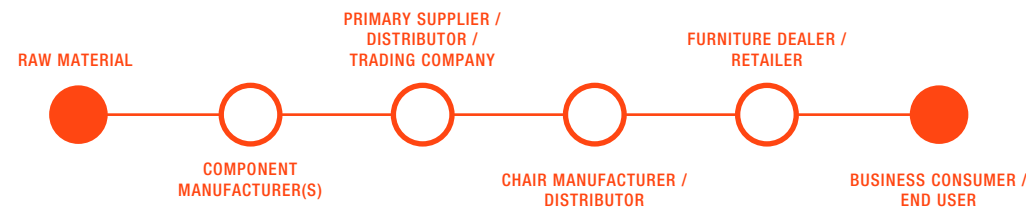

9to5 Seating Supply Chain For Office Seating

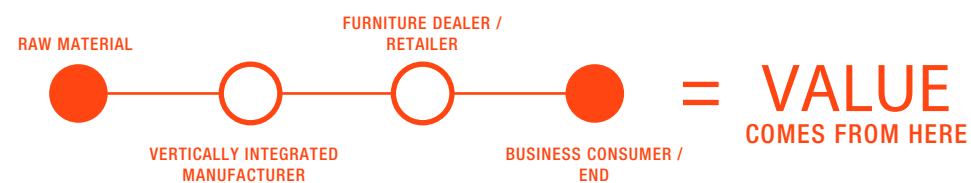

green practice

9to5 Seating Commits to Think & Act Green

9to5 Seating is committed to sustainable and environmentally responsible business practices. This global perspective is endorsed and executed throughout every aspect of our corporate culture, and within our warehousing, manufacturing and office facilities. We are proud to demonstrate our commitment by offering GREENGUARD Certified products, participating in the U.S. Environmental Protection Agency's Waste Wise Program, and have been awarded the prestigious LEED® NC Gold Certification for our factory and corporate headquarters.



Environmental Commitment in Action

9to5 Seating's corporate headquarters uses a rooftop photovoltaic panel system to generate electricity for the facility. To view how much power we are generating in real-time visit our solar portal at www.9to5seating.com/solar

Over 30 years, the system will offset:

- 6,102,370 lbs of CO₂ | a leading cause of global climate change
- 4,192 lbs of NO_x | a leading cause of smog
- 1,048 lbs of SO₂ | a leading cause of acid rain
- 1,215 lbs of particulates | a leading cause of asthma

6,102,370 lbs of CO₂ is equivalent to the amount absorbed by 13 acres of trees over their lifetime

GREENGUARD Gold Certified

Our entire product line earned GREENGUARD Gold Indoor Air Quality Certification issued by the GREENGUARD Environmental Institute. The GREENGUARD Indoor Air Quality Certification Program assures that products designed for use in office environments and other indoor spaces meet strict chemical emissions limits.

For products intended for use in schools, daycares or other environments where children spend significant periods of time, the GREENGUARD Gold Certification Program offers the most strict certification criteria. It is referenced by both The Collaborative for High Performance Schools (CHPS) and the Leadership in Energy and Environmental Design (LEED) Building Rating System. Products certified to this standard are also suitable for use in environments where senior adults work or reside.

The GREENGUARD Gold Certification Program's requirements comply with the State of California's Department of Public Health Services Standard Practice for Specification Section 01350 (California Section 01350) for testing chemical emissions from building products used in schools and other environments. As such, GREENGUARD Gold Certified products can be used to earn valuable credits in the CHPS Best Practices Manual for K-12 schools, the US Green Building Council's LEED® Green Building Rating Systems, the Green Guide for Healthcare, the NAHB Green Building Guidelines, Green Globes, Regreen and many other building codes, standards and specifications.

9to5 Seating products:

- Contribute to healthier interior environments.
- Add points for LEED Certification.
- Offer fabrics made from 100% recycled content. (Fabrics made from recycled content are identified with the symbol in the Grade-In section of this price book pages 14 – 23.)
- Manufactured using plastic, nylon, steel, aluminum and polypropylene components that are 100% recyclable.
- Use suppliers that share an earth-friendly philosophy.
- Certified below chemical emissions limits for TVOC, Formaldehyde, Total Aldehydes, Individual VOCs, 4-phenylcyclohexene.

Environmental Data Sheets for all 9to5 Seating products can be found at our web site www.9to5seating.com.

For more information about GREENGUARD programs visit www.greenguard.org.



lifetime warranty

9to5 Seating products are manufactured with meticulous attention to detail to achieve a level of quality that is free from defects in material and workmanship. In an effort to stand behind this philosophy, 9to5 Seating warrants to the original purchaser of the product and from the original date of sale, the following:

For All Series Except Logic Plus, Enduro™, and Strata™ Heavy Duty (HD) Series: Lifetime Warranty to the original end user, the company will repair or replace, at its option, without charge to the original purchaser only, factory defective structural and mechanical parts. This warranty is for single shift, standard commercial usage, defined as a standard 8 hour work day, five days a week. Weight limitations vary by product.

Upholstery fabric and foam is warranted against wear through and deterioration during normal usage for a period of five (5) years. However, the company does not warrant leather against routine scratching and scuffing, as all leather is subject to minor blemishes during use. COM and COL are not warranted. Due to natural variations in material, furniture containing leather is sold subject to normal variations and/or irregularities of color, texture, and grain.

For Logic Plus Heavy Duty (HD) Series:

9to5 Seating warrants the Logic Plus HD series of single-shift chair for a period of ten (10) years to the original purchaser. The company will repair or replace, at its option, without charge, defective structural and mechanical parts. This warranty is for single-shift applications with persons weighing less than 500 lbs.

For Logic™, Enduro™, Theory™, Aria™ and Strata™ Heavy Duty (HD) Series: 9to5 Seating warrants the Enduro, Theory and Strata HD series of multi-shift chairs for a period of ten (10) years to the original purchaser. The company will repair or replace, at its option, without charge, defective structural and mechanical parts. This warranty is for multi-shift applications with persons weighing less than 350 lbs.

Upholstery fabric with an abrasion resistance performance rating of 150,000 double rubs or more and foam are warranted against wear through and deterioration for a three (3) year period of multiple shift use.

Claim Process

Should parts fail for any model during normal use within the applicable warranty period, please provide 9to5 Seating with a description of the failure and proof of purchase (Sales Order number located on the bottom

of the chair) and if necessary you may need to return the defective part, freight prepaid to 9to5 Seating for inspection, repair and/or replacement, together with a copy of original sales receipt. Labor and installation service is not covered under warranty. Please do not send parts without prior authorization.

Send Parts to:

9to5 Seating - Warranty Department
3211 Jack Northrop Avenue
Hawthorne, CA 90250

9to5 Seating will inspect the part in question, repair or replace at its option any defective part at no charge to the original purchaser and return defective item thereafter. This warranty does not apply to product or parts of product that have been subjected to misuse or abuse, accident, alteration, unauthorized repair or which have been damaged in transit. You agree to indemnify and hold harmless 9to5 Seating, its officers, directors, shareholders, employees, and agents from any actions, claims, demands, damages, liabilities, costs, and strict liability in tort or contract, or any other legal theory arising out of the misuse or abuse, alteration, or damage in transit of the product.

Limitation of Liability

Under no circumstance, including but not limited to breach of contract, breach of warranty or negligence, shall 9to5 Seating be liable for lost profits, loss of goodwill, stored data, general, special, consequential or exemplary damages, even if 9to5 Seating had notice of these damages or they were foreseeable. 9to5 Seating shall not be responsible for verifying dealer's or customer's description of needs, data, or the fitness for a particular purpose of goods. 9to5 Seating's Liability in all cases shall be limited to repair or replacement of the defective parts, or the purchase price of the product. Damages resulting from misuse, abuse, alteration, negligence, or accidents are not covered under this warranty.

9to5 Seating makes no warranty that any of its products are suitable for any particular purpose and makes no other warranties, express or implied, other than those set out here. As codes and standards vary from one jurisdiction to another, references to compliance are solely for convenience and without any representation as to accuracy or suitability. Users must verify the suitability of such information or product for their specific application. In no event shall 9to5 Seating be liable in either tort or contract for any loss or direct, special, incidental, consequential, or exemplary, damages.

EXCEPT AS OTHERWISE PROVIDED, 9to5 Seating MAKES NO OTHER WARRANTIES, EXPRESSED OR IMPLIED, INCLUDING BUT NOT LIMITED TO THE WARRANTIES OF MERCHANTABILITY AND FITNESS FOR A PARTICULAR PURPOSE.

ANSI/BIFMA

The Business and Institutional Furniture Manufacturer's Association (BIFMA) has developed tests which have been approved by the American National Standards Institute (ANSI) for determining the strength and durability of seating in its everyday use. This statement does not serve as a warranty or guarantee, however 9to5 Seating products found within this price list generally meet or exceed applicable BIFMA and ANSI standards.

Warranty Exceptions:

- Color-fastness or matching of colors, or textures occurring in leather, or other materials that naturally exhibit inherent color variations
- Product normal wear and tear, which is to be expected over the course of ownership
- Damage caused by the carrier in-transit, which will be handled as separate terms and/or claims against the carrier
- Damage caused by delivery/installation contractors, which will be handled as claims against the designated company
- Failures and damage which result from negligence, abuse, accident or misuse
- Damage by markings or staining; damage by sharp objects or imprinting from instruments
- The warranty is limited to replacement or repair and does not cover cost of transportation, labor or installation.
- Products exposed to extreme hot and cold temperatures or excessive dry environments
- Damage of textiles from exposure to sunlight and UV rays.
- Products that were not installed, used, or maintained in accordance with product instructions and warnings

9to5 Seating reserves the right to make changes in design and construction or discontinue products without prior notice.

9to5 Seating reserve the right to make changes to the lifetime warranty or price book

Since textiles vary in weave, thickness and memory, some creasing and/or gathering may occur during the upholstery application process. Due to natural variations over which we have no control, all chairs are sold subject to minor irregularities of color, surface, grain, and texture. Textiles are sold subject to minor variations of color. Because leather is a natural product, variations of texture are common and should be expected. Leather will contain natural markings such as neck wrinkles, scratches, backbone marks and stretch marks. These distinctions give leather its unique characteristics and are considered to be part of the natural beauty of leather.

green practice

LEED®

At its core, a green building is a better performing building. It uses fewer resources and offers a better place to work through improved energy and water efficiency, better air quality, and access to natural daylight. We have been awarded the LEED® NC Gold Certification for our newly constructed corporate headquarters and manufacturing facility.

LEED is an internationally recognized green building certification system which promotes improved performance in energy savings, water efficiency, emissions reduction, improved indoor environmental quality, stewardship of resources, and sensitivity to their impacts.

Sustainable aspects of 9to5 Seating's headquarters building design contributing to LEED Gold Certification include:

- Rooftop photovoltaic panel system generating approximately 90% of electricity required for facility operation.
- Reduction of energy consumption through increased natural day lighting to enable factory to operate during an average day with lights off.
- Use of LED lighting throughout office space for further energy savings.
- Site selection promoting development density and community connectivity.
- Providing alternative transportation including access to public transportation, parking for low emitting and fuel-efficient vehicles.
- Quality control of storm water runoff.
- Decrease in heat island effect.
- Use of water efficient landscaping.
- Reduction of water usage by 40%
- Optimization of energy performance through a 28% improvement over 2011 California Title 24 code.
- Recycling or salvaging 75% of construction waste.
- Use of recycled content and regional building materials.
- Increased ventilation to promote indoor environmental quality.
- Use of low-emitting adhesives, sealants, paints, coatings and flooring systems.



Manufacturing

We are committed to reducing, reusing and recycling the by-products and waste generated during our manufacturing process through our membership in WasteWise.

WasteWise is an U.S. Environmental Protection Agency's program in which organizations track their waste reduction efforts to benefit the environment.

9to5 Seating's efforts to reduce manufacturing waste include:

- Optimize machinery cycle times to manufacture parts in minimal time increments.
- Evaluate environmental effects before pursuing new products or purchasing equipment to ensure alignment with environmental commitments.
- Select materials that reduce or eliminate toxic and environmentally damaging materials from the manufacturing equation.
- Utilize water-based, environmentally friendly adhesives throughout our manufacturing facilities.
- Use of recycled raw materials in the production urethane components when possible.
- Sort and recycle rejected plastic components via five re-grind machines.
- Employ molded foam production in over 95% of products, greatly reducing scrap urethane.
- Work exclusively with plywood suppliers that participate in forest restoration.

- Collect and recycle all excess fabric, dacron and leather.
- Accurately determined the current carbon footprint through Life Cycle Assessment (LCA).
- Identified hot-spots in energy consumption and associated CO2 emissions.
- Optimized energy efficiency and reduced CO2 and GHG emissions contribution from production processes.
- Identified solutions to neutralize CO2 emissions that cannot be eliminated through energy saving measures.



general information

Hours

Order Desk: Monday - Friday - 6:00 a.m. to 5:00 p.m. P.S.T.

Shipping & Receiving: 8:00 a.m. to 4:00 p.m. P.S.T.

Condition of Sale

Possession of this price book does not necessarily constitute authority to purchase.

Minimum Order Size

No minimum order required. Orders of 4 chairs or less will be charged \$15 per chair net shipping charge with the exception of the Sophie series which requires a 4 model unit minimum (excluding tables and accessories). A shipping surcharge of \$100 net will apply to shipments of 3 model units of less.

Payment

9to5 Seating accepts all major credit cards, company checks, cash, and terms payment for approved accounts. Credit card payments are subject to a 3% service charge. A \$35.00 fee will be charged for returned checks.

Terms

Standard terms are net 30 days from date of invoice. Please respect these terms in order to protect your competitive pricing. Credit terms may be changed or canceled at 9to5 Seating's discretion.

1. All new accounts are required to remit a 50% deposit of the initial order's total dollar value prior to the order entry and the balance must be paid at the time of pick up or release to common carrier. A line of credit may be established upon acceptance of satisfactory references and the completion and signing of credit application.
2. The customer will be liable for any cost incurred in attempting collection of past due amounts, including attorney fees, whether or not a lawsuit is filed. Past due accounts are subject to a 2% per month (24% per annum) late charge, or maximum amount permitted under local law, for each thirty days, or part thereof, the outstanding balance remains unpaid beyond the thirtieth day after invoice date. Withholding of payments, because of carrier damages, shortages or other disputes is illegal and subject to charges.
3. Orders delayed due to credit hold will be rescheduled for production once the order has been credit released. A new lead time will be given at that time. Please contact customer service to coordinate details.

Prices

All prices are suggested retail and are subject to change without notice. We make every effort to notify all customers of such changes. Prices in effect at the time of shipment will prevail. Please refer to our online price book for the latest changes including product drops and additions.

Order Acknowledgement

An order acknowledgement will be faxed or emailed to you upon receipt of the order to confirm quantities, items ordered, and prices effective at the time of the order acceptance (prices may vary from the published list) unless there is a credit issue or you are otherwise contacted. Be sure to read these acknowledgements and contact us immediately if incorrect.

Shipping

Complete and specific instructions for shipping should be given at the time an order is placed. Orders that do not have specific instructions will be routed by the best method of shipment in accordance with the judgement of our traffic department. ANY changes to shipping instructions must be faxed into our office. Shipping weight and cubic dimensions shown in our price list are subject to variation.

Standard shipments are made via common carrier, unless otherwise requested by the customer. Special routing requests made by the customer or the consignee may result in additional charges.

Standard deliveries are dock-to-dock and are scheduled to occur Monday through Friday between 8:00 AM to 4:30 PM. 9to5 Seating reserves the right to charge the customer for non-standard customer delivery requirements that may include delivery appointments, drop shipments, inside deliveries, residential, limited access, or requests for trucks with lift gates. Additional charges may also be incurred for redeliveries or re-consignments if the initial delivery cannot be made for any reason. 9to5 Seating will not be held responsible for issues or costs to the customer arising from carrier transit delays or missed appointments. For information concerning these charges, please contact Customer Service.

Service Charges

Below is a list of frequently requested Service Charges:

- Call prior to delivery for verification. This is not a delivery appointment (no charge).
- Reconsignment fee of \$50 will be applied when changing consignee address after shipment has been tendered to a carrier
- Lift gate delivery (no dock) \$65
- Shipments to schools, churches, military bases, residential addresses \$65
- In the event that no one is available to receive a shipment and a redelivery is necessary, a charge of \$65 to \$150 will be billed to customer for redelivery. Charge depends on carrier.
- 9to5 Seating strives to use the best shipping method possible for every shipment. The factory may ship an order fully assembled and bagged, however this is not standard for all shipments. If you require blanket wrap delivery, you must contact 9to5 Seating to confirm this shipment method and confirm that the order acknowledgement sent to you reflects 'AB' as the shipment method. Additional charges may apply.
- Limited access locations where a dock is difficult to access with a 53 ft. trailer will be charged minimum \$65.

Guaranteed Delivery and Delivery Appointment

Shipments are not guaranteed. Guaranteed service is available at an additional cost. Please contact Customer Service for more information. We will work to arrange a specific delivery time with the carrier. Service guarantees contracted with carrier are done solely at the request of the customer and 9to5 Seating in no way assumes responsibility financially or otherwise for any costs incurred by the customer as a result of a carrier's failure on a guaranteed shipment. In the event of a carrier's failure on a guaranteed shipment, the associated guaranteed service fee will be removed.

Expedited Freight

Expedited service is available at an additional cost. Please contact Customer Service for more information.

Drop Shipments

9to5 Seating will not drop ship without prior approval. Additional charges may apply; contact Customer Service for additional information.

condition of sale

Will Call

Will Call orders will receive notification once orders are ready to be picked up. Customer will have 3 business days from notification to pick up the order. If the order is not picked up within this time frame, the order will be invoiced and storage charges will start at a rate of \$30 per each business day until order has been picked up.

Freight Damage or Shortage

Before accepting a shipment from the carrier, check the boxes for visible damages. If a shortage or damage occurs during transit, it should be noted on the freight bill of lading at the time of delivery, and a claim filed within 7 days from receipt of product. If concealed damage is discovered after delivery, request inspection from the delivering carrier IMMEDIATELY and save all packing materials until inspection is made. Contact customer service as soon as possible to report damage or shortage.

For all Will Call orders, make sure to inspect merchandise thoroughly. 9to5 Seating will not be liable for any damage or shortage to merchandise after it has been signed for at our dock.

9to5 Seating will not be liable for any installation costs that result from freight damage.

Cancellations & Returns

Due to immediate production scheduling, orders which have entered any stage of production cannot be cancelled. All 9to5 Seating chairs are made to order, custom designed chairs and are not "off the shelf". Requests for cancellation are not accepted until confirmed by 9to5 Seating. Product may only be returned after receiving a Return Merchandise Authorization number from 9to5 Seating. Returns are subject to restocking charge equivalent to 35% of the net order plus freight. Unauthorized returns will be refused.

Replacement Parts

When ordering a replacement part, call Parts Department at 1.888.925.7328 or e-mail to parts@9to5seating.com. For your convenience you can also submit warranty requests through our website by navigating to the warranty page and selecting the Warranty Request Form. As a helpful tip, have your 9to5 Seating Sales Order number available and please reference your instructions sheet to properly identify the correct part for your 9to5 Seating product.

Replacement parts are shipped within 48 hours from time of request. 9to5 Seating does not reimburse for labor and installation costs related to warranty replacements. Replacement parts needed to repair freight damage can be granted only if the request is received within 5 business days of receipt of the merchandise.

Product Design

9to5 Seating reserves the right to make alterations in design and construction or to discontinue products without prior notice.

dimensions

Outside Width (W)

Distance measured at widest point of chair.

Outside Depth (D)

With the outside back of chair against wall, the distance from the wall to the front edge of seat.

Outside Height (H)

Distance from floor to highest point of back.

Seat Width (SW)

Distance measured at widest point of seat's side edges.

Seat Depth (SD)

Distance is measured using the Bifma CMD (Chair Measuring Device) from the most prominent point of the lumbar to the front edge of the seat

Seat Height (SH)

Distance is measured using the Bifma CMD (Chair Measuring Device) from the floor to the bottom of the device on the front edge of the seat. The CMD weighs 100 lbs.

Back Width (BW)

Distance measured at widest point of back's side edges.

Back Height (BH)

Distance measured from inside edge of rear seat to top edge of back.

Inside Arm Width

Distance between arm, typically measured from mid-point.

Arm Height

Measured from the floor to top edge of arm.

lead time

9to5 Seating intends to have all approved orders ready for shipment within the below guidelines. However, there may be delays due to causes beyond our control. Orders received after Noon, PST will be considered as having been received the following day. Credit must be cleared before processing. 9to5 Seating is not responsible for late deliveries from freight carriers.

Lead Time

@NCE ships in 24 hours.

5 Business Day Quick Ship includes Grades A, B, C, D, and L3 selections found in the current express fabric card programs. Quantity is restricted to twenty-five (25) chairs total per order.

Please specify "5 Day Quick Ship" on a separate purchase order to ensure proper handling and delivery time. DO NOT COMBINE with any other purchase order. In the event that a purchase order is not marked, order will be scheduled per our standard lead time below.

Standard 15 Day Lead Time is fifteen (15) business days or less and includes L4 and L5 leather and any 9to5 carded fabric/vinyl for quantities up to fifty (50) chairs total per order.

All COM and COL orders up to fifty (50) chairs will ship within fifteen (15) business days from receipt of fabric or leather.

Standard 25 Day Lead Time is twenty five (25) business days or less includes L5 leather and 9to5 carded fabric/vinyl for quantities over fifty (50) chairs total per order. Applies to all Sophie models regardless of quantity.

Standard 25 day lead times apply to all non-carded, graded textiles from CF Stinson, Designtex, Maharam, and Momentum (subject to availability).

Please call Customer Service for lead times on orders over 100 chairs.

order procedure

To Place Order

Follow one of the following two choices to place order:

1. Fax your order to: **888.925.SEAT**
2. E-mail your order to: **sales@9to5seating.com** or your dedicated customer service representative.

Specify complete model number, color, quantity, ship to address, payment method and purchase order number. In the event that an error is made in production of the chair, the hard copy of the purchase order will be used as the resolution document.

Model Number Structure

When ordering, please create model number in accordance with the nomenclature below. Refer to Creating Series Model Number in the top right hand corner of specific model's price book page.

Acclaim

MODEL NUMBER	CONTROL	ARMS	GRADE	CASTERS	PACKAGING	OPTIONS
2780	Y5	A27	L5	C6S	PAC	12P

* GT MODELS DO NOT HAVE A CASTER CODE

Core

MODEL NUMBER	CONTROL	ARMS	PLASTIC COLOR	GRADE	CASTERS	PACKAGING	OPTIONS
2260	Y5	A23	PGA	C	C22B	PAC	12S

* GT MODELS DO NOT HAVE A CASTER CODE

Diddy

MODEL NUMBER	CONTROL	ARMS	GRADE	CASTERS	PACKAGING
2450	S3	A24	C	C67	PAC

* END ARM FOR POSE USE ONLY

Sophie

MODEL NUMBER	CONTROL	ARMS	FRAME COLOR	GRADE	PACKAGING	OPTIONS
8111	GT	A80	MBF	F	AC	

* CHROME FRAME COLOR (CF) IS NO LONGER AVAILABLE AND HAS BEEN REPLACED WITH POLISHED ALUMINUM (PF)

Zoom

MODEL NUMBER	CONTROL	ARMS	GRADE	PACKAGING	OPTIONS
1115	T1	SF	PA	APD	C12AB

Order Acknowledgement

Unless there is a credit issue or you are otherwise contacted, an order acknowledgement will be faxed or emailed to you upon receipt of the order to confirm quantities, items ordered, and prices effective at the time of the order acceptance (prices may vary from the published list). Be sure to read these acknowledgements and contact us immediately if incorrect.

Shipment Notification

Upon shipment of an order a shipment notification will be faxed or emailed with carrier information.

packaging codes

How to Specify

9to5 Seating offers several packaging methods for most models. Please note not all packaging codes are available for each model. Reference the price book page for the model in question to view the packaging methods available. All available packaging methods and their corresponding prices can be found at the top of the price book page.

After determining the appropriate packaging method please add the packaging code to the model nomenclature of the model as it appears on your purchase order.
(example: 1725-M1-A4-101-**AB**)

AB - Assembled in Bag for Will Call and Blanket Wrapped

The chair will be fully assembled and covered with a clear plastic bag for protection from dust. Chairs shipping via blanket wrap carrier will be produced with packing method "AB" as the chairs will be picked up at the dock fully assembled in the will call area.

PAC - Partially Assembled in Carton

The chair will be produced and packed partially assembled typically with seat and back separated, arms and controls pre-assembled in a shipping carton. Specially designed spacers are used to position all chairs in the carton and prevent freight damage.

BAC - Back Assembled in Carton

The chair will be fully assembled with exception of the base, gas lift and casters removed and packed into a specially designed carton for this hardware. The chair may be removed, casters placed in the base, gas lift placed in the base and the remaining chair set on top of the cylinder. No tools are required

AC - Assembled in Carton

The chair will be fully assembled and placed in a carton. This applies primarily to guest chairs which must ship fully assembled to accommodate chair design. Some guest chairs ship with multiple chairs in one carton

upholstery selection

Fabrics

Choose from thousands of different fabrics, comprised of varying price grades offered through 9to5 Seating's fabric cards. If you still can't find what you are looking for, you may choose from any of the textiles offered by one of our textile partners. There are thousands of patterns and colors to choose from. To make this easy for you, we have graded-in their entire product lines. Please see pages 16 to 33 of this Price Book.

Leather

9to5 seating offers three grades of leather. L3 and L4 all are upholstered with leather on the seating surface and vinyl on the back and side boxing. L5 is an ALL leather cover.

9to5 also has COL (customer own leather) program

L3 is a glove-soft, top grain European hide, available in Black

L4 is also a glove-soft, top grain Italian cowhide leather available in colors. L4 executive chairs are available in 9to5 Seating premium leather colors.

L5 is a luxurious Italian full grain semi-aniline dye leather with a soft hand and smooth supple surface with even coloration throughout the entire hide. Available in 39 colors.

Two-Tone Contrasting Seat and Back

When the seat and back fabric or vinyl are different on a single chair, clearly indicate your selection for both the seat and back on your purchase order. All fabric upholstered chairs may be ordered with two-tone upholstery for no additional charge. **If the two upholstery selections are of different grades, the chair will price at the higher of the two grades.**

fabric program

For memo samples or availability call CF Stinson at **800.841.6279**

CF STINSON

√: CURRENT CARDED FABRIC
*: PATTERNS OR COLORS BEING PHASED OUT

PATTERN	PATTERN	C.C.F.	PATTERN	PATTERN	C.C.F.	PATTERN	PATTERN	C.C.F.	PATTERN	PATTERN	C.C.F.	PATTERN	PATTERN	C.C.F.	PATTERN	PATTERN	C.C.F.
ACADIA EPINGLE*	G+\$150		CANNON BEACH	G+\$50		DART	D		HAPPY TAPPY	G+\$50		MARTINI	G		PROFILE	F	
ACANTHUS	G+\$50		CAPRENI	G		DASH	E		HAVEN	F		MATRIX	E		PROMENADE	E	
ACE	D		CARLISLE	D		DEFLECTION	F		HELIX	G		MESA	G+\$200		QUEUE	F	
ACROBAT	G		CASABLANCA	G		DETAIL	G		HI-FI	D		MICA	E		R.E.I.L.		
ADIRONDACK	F		CASSIDY	D		DEZA	G+\$50		HIGHLIGHT	D		MINGLE	G		RADIANCE	G+\$100	
AERO	F		CATALINA	G		DIFFUSION	G+\$100		HIVE	C		MOCCASIN	D		RAFFIA	E	
AFFINITY	G		CATALYST	D		DIVA	E		HORIZONS	G		MODENA	G		RAINIER	D	
ALCHEMY	F		CATWALK	F		DODGEBALL	F		HOT SPOT	F		MONHEGAN	G		RALLY	C	
ALFRESCO	F		CELESTE	F		DOUBLE TIME W/ AGION	G+\$50		HOURLASS	G		MONTAGE	F		RAQUETTE	F	
ALGIERS	G+\$50		CHAKRA	G+\$50		DUET	F		HUDSON	G+\$50		MONTANA	D		REALM	F	
ALIGNMENT	G		CHANNEL	E		E'LAN-HC	G+\$200		HUSH	G		MOXIE	G		REFRACTION	D	
ALOHA	G		CHAUNCEY	E		EFFERVESCENSE	G		I SPY	G		MUMBAI	G+\$100		RESPIRE	G	
APEX-CRYPTON® REVL™	E		CHI W/ AGION®	G+\$50		ELDERBERRY	G		IMPRESSION	G+\$50		NATURAL WORLD	G		RETROGRADE	C	
ARC	E		CHLOE	F		ENGLISH PUB	D		INSIDE TRACK	E		NAUGALEATHER	D		REVOLUTION	F	
ARCHETYPE	E		CHROMA	E		ENTRADA	G		INTERVAL	F		NAUGASOFT	D		REVOLVE	G+\$50	
ARIOSO	F		CIELO	G+\$150		EQUINOX	F		ISABELLA	G		NEOCHROME III	D		RIALTO	D	
ASPEN	G		CINNAMON BLOSSOM	G		EXCURSION	D		JALA	G+\$100		NEST	G		RIDDLE	D	
ATLAS	C		CIRQUE	E		EXPRESSIONS	D		JAM SESSION W/ AGION	G+\$50		NEW HEMPSTEAD	D		RIPPLE	G+\$50	
AUBERGE	G		CIRRO	G		FAST LANE	D		JAMBI STRIPE	F		NEXT SCENE	G		RIVERA	G	
AVANT	D		CITADEL	D		FENESTRA	G+\$50		JASMINE SCREEN	G		NIMBLE	F		ROGUE II	C	
BALANCE BEAM	G		CLEAN SLATE	E		FIGMENT	G		JUMP W/ AGION	G+\$50		NOVA	E		SALINAS	G+\$100	
BALI	G		COCO	F		FIREFLY	G		JUXY	G		NOW & ZEN W/ AGION	G+\$50		SAN SIMEON	G+\$50	
BAMBU-ENVI™	F		COLDEN	G		FIZZ	E		KAMBALA	G+\$50		OLYMPUS	G		SATELLITE	E	
BANYAN	G		COLORGUARD	D		FLEX	F		KENNEBUNK	G		ON THE MONEY	F		SCINTILLATE	G	
BARI	G		COMEBACK	G+\$50		FLIGHT	G+\$50		KETANA	G+\$50		ORBIT	E		SCOUT	D	
BASS LINE	F		CONCENTRIC	G		FLIP FLOPS	G		KILKENNY TWEED	D		OSCILLATE	G+\$50		SCRIPT	E	
BEATBOX	F		CONNECT	D		FLORENTINE	F		KINETIC	F		OUTLANDER	D		SEAGRASS	G	
BEEP BEEP	G		CONTINUUM	E		FOLIO	G		KNOCK KNOCK	G+\$50		OXFORD	D		SEBAGO	G	
BESPOKE	E		CORE	D		FRACTAL	G		KUSARI	E		PACIFICA	G+\$50		SECOND ACT	G	
BISTRO	D		CORIUM	G		FREEHAND	E		LABYRINTH	G		PANORAMA	G		SEDONA	G+\$200	
BLIP	D		COTTONWOOD	F		FREQUENCY	E		LAREDO	C		PARK AVENUE	G		SENTRY - HC	D	
BLOCK PARTY	G		COURTYARD	G		FURROWS	E		LATITUDE	D		PATRIOT PLUS II	D		SEQUENCE	D	
BLOOM	G+\$100		COZY	F		FUSE	C		LAVA	G+\$50		PATTERN	GRADE		SHANTUNG	D	
BON VOYAGE	G		CRANBROOK LOOP	G+\$300		GEODESIC	G		LEAPS & BOUNDS	G		PENINSULA MOHAIR	G+\$200		SHIFT	D	
BONGO	G		CRISS CROSS	D		GEOMET	E		LIFT	G+\$50		PERIMETER	E		SIDELINE	E	
BRETON	G		CRUISIN'	G		GLISTEN	G+\$200		LINE DANCE	F		PERSUASION	F		SILVERADO W/ AGION®	G+\$50	
BRILLIANT	D		CRYPTON METRO	E		GRADATION	E		LINUS	F		PETALS	F		SIMPLICITY	D	
BRYANT PARK	C		CRYSTON SUEDE	E		GRAND SIERRA	D		LUCENT	G+\$100		PINBALL	F		SKYLINE	G	
BUBBLERAKE	G+\$50		CRYSTALLINE	G		GRAVITY	F		MAKEOVER	G+\$50		PIVOT	D		SLEEK	E	
BUDGET BLACK	B		CURRENT	G+\$50		GRILLE	E		MALI	G		PLEXUS	G		SLEEPING BEAR DUNES	F	
BURKSHIRE	D		CURVES AHEAD	G		GROVE	G		MANCHESTER	F		POLKA	D		SLIGHTWAVE	G	
CALIBRATION	G		CYMA	G+\$50		HANDS ON	F		MARIMBA	F		PORTICO	F		SMILE	F	
CALLA	G		DADDY-O W/ AGION	G+\$50		HAPPY HOUR	E		MARQUETRY	G		POSH	F		SMOOTHIE	D	
CAMINO	G+\$200		DAKOTA	E								PRISMA	G		SNUGGLE	E	
															SOLITAIRE	E	
															SPARK	G+\$100	

fabric program

For memo samples or availability call CF Stinson at 800.841.6279

CF STINSON

√: CURRENT CARDED FABRIC
*: PATTERNS OR COLORS BEING PHASED OUT

PATTERN	PATTERN	C.C.F.	PATTERN	PATTERN	C.C.F.	PATTERN	PATTERN	C.C.F.	PATTERN	PATTERN	C.C.F.	PATTERN	PATTERN	C.C.F.
SPINDLES	G+\$50		VIBE	F										
SPIRIT MILLENNIUM	D		VIEW	G										
SPLASH	G		VINEYARD	G+\$100										
SPRINT	C		VINTAGE	G										
SQUIRE	F		VISION	D										
STAT-CON	F		VOLTAGE	G										
STELLAR	E		VOLTERRA-HC	G+\$200										
STERLING W/ AGION	G+\$50		VORTEXIA	G+\$50										
STIPPLE	E		WALK THE LINE	G										
STITCH IN TIME	D		WATERWAND	G+\$50										
STRAIGHT AND NARROW	F		WHIRL	G										
STRAND	D		WHISPER	D										
STRATFORD	G+\$150		WHITNEY	E										
SUMATRAN PALM	G		WICKER	G										
SUMMIT	F		WILLOW TALK	G										
SUNBURST	G		WINK W/ AGION	G+\$50										
SUNDANCE W/ STAKLEEN™	F		WISH	G+\$150										
SUNSWEPT	G		WYATT	E										
SUPERSILLYNESS	G+\$50		YBOR	G										
SWIVEL	G		ZIGGY	D										
SYMMETRY	G		ZODIAC	E										
SYMPHONY CLASSIC	D		ZOOM	F										
TENDER	G+\$150													
TENDRIL	D													
TESSELLATE	G+\$50													
TESSUTO	E													
THICKET	D													
TORUS	F													
TRACING	E													
TRANQUILITY	G													
TRANSCEND	D													
TRIBECA	D													
TRUE PATH W/ AGION	G+\$50													
TWEED	F													
UMBRIAN RAIN	G+\$50													
UP TEMPO W/ AGION	G+\$50													
VALISE	D													
VANISH	G+\$50													
VAPOR	G													
VARATI	G+\$50													
VEGAS	D													
VELOCITY	F													
VERDURE - ENVI™	E													
VERMONT	G													

fabric program

For memo samples or availability call DesignTex at 800.221.1540

DESIGNTEX

√: CURRENT CARDED FABRIC
*: PATTERNS OR COLORS BEING PHASED OUT

PATTERN	PATTERN	C.C.F.	PATTERN	PATTERN	C.C.F.	PATTERN	PATTERN	C.C.F.	PATTERN	PATTERN	C.C.F.	PATTERN	PATTERN	C.C.F.	PATTERN	PATTERN	C.C.F.
ACACIA	F		CASSAVA	G		FLUX	G		LAUREATE	G		OXFORD STRIPE	G+\$50		SAMBA OTRA VEZ	G+\$50	
ADDA	C		CATALYST	E		FORTUNA	G+\$100		LEAF DOT	F		PALOMINO	F		SANDPIPER SC	D	
ADLER	E		CESTINO	G+\$50		FRIENDLY FAUX	G		LEAFETTE	E		PARADIGM	G+\$250		SANTIAGO	G+\$150	
AGGREGATE	E		CHAPITEAU	E		FUSE	G		LEAP	F		PARGA	E		SAUGATUCK	E	
AINSLEY	G+\$100		CHECKER STRIPE	G+\$100		GALE	F		LEAVES	F		PAVILION STRIPE	E		SAVILE PLAID	G+\$100	
AKSEL	F		CHEVRON	G+\$300		GALLONE	F		LELAND	E		PENNINGTON	G+\$50		SEE SAW	G	
ALCAZAR	F		CHROMATIC	E		GAMUT	D		LINARI	E		PENTLAND	G+\$200		SEED	F	
ALCHEMY	E		CIRCA	F		GAUGE	G+\$50		LINDOS	F		PERPLEX	D		SEQUENCE	G	
ALEMANY	G		CIRCOLO	E		GENOISE	CALL		LINO	E		PETITE FLORET	F		SETT	G+\$50	
ALISTAIR	F		CIRCUMFERENCE	G+\$50		GLAZE	F		LIORRET	E		PHASE	E		SHIBORI STRIPE	G	
ALPINE	E		CLAIRE	G+\$150		GLEAM	F		LITTLE DOT	F		PIGMENT	G+\$50		SHIMMERING TIDE	G+\$100	
AMARANTH	G	√	CLERKENWELL	CALL		GRADATE	G		LITTLE PLAID	E	√	PIKI	G		SIGNAL	G+\$50	
AMUSE	G		CLOSED LOOP	E	√	GRAMERCY	G+\$250		LOFTY	E		PIKA	D	√	SINGING IN THE RAIN	E	
AMWELL	CALL		CLYDE	G+\$100		HASHTAG	E		LOLLAND	G+\$200		PINBALL	G		SKYE	G+\$100	
ANNEX	F		COBBLE	G+\$300		HATCHMARK	G+\$50		LOOP TO LOOP	G+\$50		PIVOT	F		SORANO	E	
APPLESEED	F		COLORBLOCK	G		HEATHER	G+\$50		LORIEN	G+\$50		PLEAT	G		SPANDAU	E	
ARGIANO	E		COLORFUL PLAID	F		HEM STITCH	E		LUDINGTON	D		POP ART	G		SPIRO	G	
ARGYLL	G+\$300		CONCEPT	G		HENRIETTA	G+\$150		LUSTER	F		PORTE	E		SPLENDOR	E	
ARRAY	G+\$150		CONVERGE	G		HEXSTRIPE	F		LYDIA	G+\$150		POSEY	G		STACKS	G	
ARTHUR	G+\$150		CROSS COURT	G+\$50		HOLMES	G+\$50		MAGLIA	G		PRAIRIE	E		STARBURST	G+\$50	
ASTER	G+\$100		CROSSHATCH	G	√	HONOR PLUS	G+\$100		MAJOLICA	G+\$50		PRECISION	E	√	STEPPE	E	
ASTRID	E		CROSSWEAVE	E		HORIZON	G+\$50		MANDALA	F		PRIME	D		STRIAE	F	
BANDA	F		CROSSWIND	F		HOUNDSTOOTH PLAID	G+\$350		MARGIN	G+\$150		QUINTESSENCE	G		SUGAR SHOOTS	G	
BARATTO	G+\$50		CULEBRA	G+\$150		HYPHEN	F		MATCH POINT	G+\$50		RADAR	F		SUNBURST	G+\$50	
BARQUE	G+\$250	√	CURRENT	F		INERTIA	G		MELANGE	E	√	RAIL	G		SWAYED	G+\$250	
BASKETRY	G+\$350		CUSCO	G+\$150		INKLING	G		MELROSE	G+\$200		RAMSHEAD	G+\$200		SWAYED	G+\$250	
BATTISTA	G+\$100		CUT & PASTE	G+\$50		INLET	F		METAMORPHOSIS	G+\$100		RAZOR STRIPE	G		SWING	G+\$50	
BEE	E		DAHLIA	G		INSIDE EDGE	F		METTA	E		REFINE	E		SWING SET	G	
BEELED LINEN	G+\$100		DAPPER	E		INTERLOCK	F		MICROGRID	F		REPPWEAVE	E		SYNTHESIS	F	
BEGUILLED BY THE WILD	F		DART	G		INTROVERT	E		MIGRATION	G+\$100		RESTORE	F		TACK CLOTH	G	
BIG DOT	F		DASHING	D		IONA	G+\$200		MINGLE	F		REUSE	G+\$50		TAFTAN	F	
BIRCH BARK PLAID	G		DELAINÉ	F		IRREGULAR GRID	F		MOD	G		RICE	F		TANGLE	E	
BIT	F		DHARMA STRIPE	E		ISOMETRY	G		MODERN TWEED	G+\$150		RIO GRANDE	G		TARASCON	E	
BLOCK PRINT	G		DICHOTOMY	G+\$100		ISOTOPE	F		MODERNE	G		RIVERGRASS	E		TERRAIN	G	
BOLT	F		DOT TO DOT	G		JAUNT	G+\$50		MOHAIR PLUS	G+\$250		RIVET	F		TESSELLATE	G+\$50	
BORDO	G		DRAFT	G		JOURNEY	G+\$150		MORNING STAR	G		RIVET PEARL	F		TETRIS	G	
BOTANIQUE	E		EASTSIDE	G	√	KABUKI	F		MOTIF	G		ROCKET	D	√	THE LAST APHID	G+\$50	
BOUCLE	G		ELGIN	G+\$200		KALAHARI	F		MYDDLETON	CALL		ROSARIO	G+\$150		TINOS	G	
BOUCLE TWO-TONE	F		ELLIPSIS	C		KAMES	G+\$300		NEGRIL	G+\$150		ROSSLYN	G+\$100		TINY HERRINGBONE	F	
BOUNCE	G		EON	F		KANTHAS	G+\$200		NERA	B		ROTARY	G+\$50		TITANIUM	G+\$50	
BRAEMAR	CALL		EPIPHANY	F		KILMORY	G+\$200		NEW SELKIRK	G+\$100		ROTHESAY	G+\$50		TO THE POINT	E	
BREENA	E		ERBA	C		KLANGE	F		NEXUS	G		ROUGH & READY II	F		TOKEN	G	
BRISBANE	G+\$150		ESSENCE	C		KOMPOSITION	F		NOBLE	E		ROUND LEAVES	G+\$50		TOMBOLO	F	
BUNTA	E		EXMOUTH	CALL		LAMBERT	G+\$50		OPHIDIAN	F		ROVE	F		TOP SPIN	G+\$50	
CAIMAN	F		FAUX SURE	G		LAQUE	E		OPULENT	E		RUMELI	E		TRACE	G+\$300	
CASCADIA	E		FLORIN	F		LATTICE	G		OSCILLATE	G		SAMBA	G+\$50		TRAMWAY	G	

fabric program

For memo samples or availability call DesignTex at 800.221.1540

DESIGNTEX

√: CURRENT CARDED FABRIC
*: PATTERNS OR COLORS BEING PHASED OUT

PATTERN	PATTERN	C.C.F.	PATTERN	PATTERN	C.C.F.	PATTERN	PATTERN	C.C.F.	PATTERN	PATTERN	C.C.F.	PATTERN	PATTERN	C.C.F.
TRANSPORT	G													
TRANSPOSE	F													
TRAVERTINE	F													
TUMBLE STONES	G+\$50													
TUMBLEWEED	G													
TURNBERRY	G+\$200													
TWEED	G+\$250													
TWEED MULTI	E													
URBAN GRID	G													
VALANKA	G													
VALET	E													
VARIANT	G+\$50													
VERSED	D	√												
VIVID	D													
VOLLEY	G+\$50													
VOX	G													
W	F													
WENSLEY	G													
WESTSIDE	G+\$50													
WHIM	F													
WINDOWPANE	E													
WINSOME	D	√												
WIRE	G+\$100													
WOOD WORK	G+\$100													
WOODCUT	F													
WREN	D													
YORUBA	G													
YUCCA	F													
ZHUBA	E													
ZOCALO	G													
ZOCALO	G													

fabric program

For memo samples or availability call Maharam at 800.645.3943

MAHARAM

√: CURRENT CARDED FABRIC
*: PATTERNS OR COLORS BEING PHASED OUT

PATTERN	PATTERN	C.C.F.	PATTERN	PATTERN	C.C.F.
A BAND APART	CALL		CHOCK	G	
ABACUS	G		CHROMA	CALL	
ABACUS STANDARD	F		CIRCLES	G+250	
ACRE	G		CIRCUIT	G	
ACROSS	G		CLIMB	G+100	
AFTERMATH	CALL		COBBLESTONE	G+350	
AGENCY	CALL		CODA BY KVADRAT	G+200	
AKIMBO	G		COIN	C	√
ALLOY	F		COIN CRYPTON	G	
ALPACA EPINGLE	CALL		COINCIDE	E	
ALPACA HERRINGBONE	CALL		COINCIDE HIGH PERFORMANCE	G	
ALPACA VELVET	CALL		COLLINE BY KVADRAT	G+\$50	
ALTER	F		COLORFIELD	CALL	
ANAGRAM	G+\$100		COLORWHEEL	G+150	
ARABESQUE	G+250		COLUMN	G	
ARIA	G+250		COMPARTMENT	CALL	
ARRAY	G		COMPOUND	G	
ARTICLE	E		CONFETTI	G+200	
ASSEMBLED CHECK	CALL		COTTON VELVET	G+350	
BANISTER	G	√	CREW	G	
BAR	C	√	CROSSPATCH	G+250	
BAR CRYPTON	G		CURSIVE	G+50	
BASEL BY KVADRAT	G		CYCLE	F	
BAVARIA	CALL		DAPPER	F	
BAVARIA STRIPE	CALL		DART	G+\$50	
BESPOKE STRIPE	CALL		DASH	F	
BIG STRIPE	CALL		DECODE	G	
BLOCKS	CALL		DECONSTRUCTED ROSE	CALL	
BORDERS	CALL	√	DINGBATS	G+200	
BRIGHT ANGLE	G+150		DISC	C	√
BRIGHT CUBE	G+150		DISC CRYPTON	G	
BRIGHT GRID	G+150		DIVIDE	C	√
BRIM	G+50		DIVIDE CRYPTON	G	
BRUSHED CAMEL	CALL		DIVINA BY KVADRAT	G+\$50	
BRUSHED CASHMERE	CALL		DIVINA MD BY KVADRAT	G+50	
BRUSHED MERINO	CALL		DOT PATTERN	G+250	
CANDID	F		DOUBLE TRIANGLES	G+300	
CANVAS BY KVADRAT	G		DRAPE	G	
CARAPACE	G+250		EDEN	CALL	
CARTOUCHE	G		ELLIPSIS	G	
CASHMERE RIPPLE	CALL		EMBOSS	G+\$50	
CENTRIC	G+100		ENMESH	F	
CHALET	G+\$50		EPINGLE STRIPE	CALL	
CHECKER	G+300		EXAGGERATED PLAID	G+350	
CHECKER SPLIT	G+300		EXCHANGE	F	
CHENILLE CORD	G+100		FACETS	G+300	

PATTERN	PATTERN	C.C.F.	PATTERN	PATTERN	C.C.F.
FASTEN	G+50		HERRINGBONE STRIPE	CALL	
FATHOM	F		HIGHFIELD BY KVADRAT	G+100	
FEATURE	G		HORSEHAIR BASKET	CALL	
FIDDLE	G+50		HORSEHAIR CHECK	CALL	
FLUTED SILK	G+250		HORSEHAIR STRIAE	CALL	
FOLD	G+\$50		HOUSTON	G+200	
FOLIAGE	CALL		HOURS	CALL	
FRACTION	G		INDUSTRY	CALL	
FRUIT	G+200		INLAY	G+200	
GARDEN	G+150		INSIGNIA	G+50	
GEOMETRI	G+300		INSTILL	F	
GRADE	G+50		JACOBS COAT	CALL	
GRID	CALL		KINDRED	G	
HALLINGDAL BY KVADRAT	G+100		KNOB	CALL	
HEDGE	G		KNOT	G+250	
HELIX	G+100		LANALUX	CALL	
HERO BY KVADRAT	G		LARIAT	F	
HERRINGBONE STRIPE	CALL		LATCH	G+50	
HIGHFIELD BY KVADRAT	G+100		LAYERS GARDEN	CALL	
HORSEHAIR BASKET	CALL		LAYERS GARDEN DOUBLE	CALL	
HORSEHAIR CHECK	CALL		LAYERS PARK	CALL	
HORSEHAIR STRIAE	CALL		LAYERS PARK DOUBLE	CALL	
HOUSTON	G+200		LAYERS VINEYARD LARGE	CALL	
HOURS	CALL		LAYERS VINEYARD SMALL	CALL	
INDUSTRY	CALL		LEDGER	F	
INLAY	G+200		LENS	F	
INSIGNIA	G+50		LETTERS	G+300	
INSTILL	F		LIFT	G+100	
JACOBS COAT	CALL		LINK	G+50	
KINDRED	G				
KNOB	CALL				
KNOT	G+250				
LANALUX	CALL				
LARIAT	F				
LATCH	G+50				
LAYERS GARDEN	CALL				
LAYERS GARDEN DOUBLE	CALL				
LAYERS PARK	CALL				
LAYERS PARK DOUBLE	CALL				
LAYERS VINEYARD LARGE	CALL				
LAYERS VINEYARD SMALL	CALL				
LEDGER	F				
LENS	F				
LETTERS	G+300				
LIFT	G+100				
LINK	G+50				

PATTERN	PATTERN	C.C.F.	PATTERN	PATTERN	C.C.F.
LINEUX	F		QUATREFOIL	G+250	
LINOMIX	CALL		QUELL	G+\$300	
MANNER	C	√	QUICK	F	
MARQUEE	E		RECOLLECTION	G	
MASSIVE PAISLEY	CALL		REEF	G+200	
MATRIX BY KVADRAT	G+150		REGATTA	G+50	
MECHANISM	G+150		REMIX BY KVADRAT	G	
MEDIUM	C	√	REPEAT CLASSIC	CALL	
MELANGE TWEED	G+300		REPEAT CLASSIC PRINT	CALL	
MEMORY BY KVADRAT	G+50		REPEAT CLASSIC STRIPE	CALL	
MERIDIAN	G		REPEAT DOT	CALL	
MESSENGER	C	√	REPEAT DOT PRINT	CALL	
METRIC	C	√	RISE	G	
MIKADO	G+250		ROVE	F	
MILLERSTRIPE	CALL		RUBRIC	G	
MIMIC	G+50		RULE	G+50	
MINERAL	F		RUNNER	G	
MINICHECK	G+300		RUNNER STANDARD	F	
MINIMAL	G		SALON	G+200	
MISTER	G+50		SCAPE	G+50	
MODE	E		SCHEMA	G	
MOHAIR EXTREME	CALL		SEAM	F	
MOHAIR SUPREME	CALL		SEQUENCE	G	
MONK'S WOOL	CALL		SHADOWBOX	G	
MORTISE	G		SHEEN	G	
NAMES	G+300		SHUTTLE	G	
OBLIQUE	C	√	SHUTTLE STANDARD	F	
OFFSET	G+100		SIGNAL	G	
ORAKELBLUME	G+300		SILK CANVAS	G+250	
OTTOMAN STRIPE	CALL		SLANT	G	
OUTBACK BY KVADRAT	G+100		SMALL DOT PATTERN	G+250	
PALIO	G+200		SNAP	G+150	
PARCHED SILK	G+300		SOFT TWEED	G+200	
PARK	G+150		SORT	F	
PAVEMENT	G+250		STAR BY KVADRAT	G+150	
PEBBLE WOOL MULTI	CALL		STATUE	F	
PENNANT	G+\$50		STEELCUT BY KVADRAT	G+50	
PICK	C	√	STEELCUT TRIO BY KVADRAT	G+50	
PICK CRYPTON	G		STRIDE	F	
PITCH	F		STRIPES	CALL	
PLAIT	F		STRUM	G	
PLAIT HIGH PERFORMANCE	G		STUDY	G+100	
PLY MESH BLACK/TAN	G+300		SUDDEN	G	
POCKET	G		SUPERWEAVE	CALL	
POINT	G+350		SURGE	G	
PRESSED PLAID	CALL		TALLY	G	

PATTERN	PATTERN	C.C.F.	PATTERN	PATTERN	C.C.F.
TANDEM	F				
TEATRO	G+\$150				
TECHNIC	C	√			
TELARY	G+150				
TEND	G				
TERRACE	G				
THE FIRM	CALL				
THE STORY OF MY LIFE	G+350				
TICKER	G				
TILT	G				
TOKYO BY KVADRAT	G+150				
TONICA BY KVADRAT	G				
TONUS MEADOW BY KVADRAT	G+50				
TOOSTRIPE	CALL				
TRANSPORT	G+250				
TREAD	G+\$50				
TREES	G+200				
TRELLIS	G+50				
TRIO	G+150				
TURN	G+\$50				
UNISOL	G+300				
URBAN	G				
VASES	G+150				
VELVET STRIPE	CALL				
VENN	G				
VESTIGE	G				
VINEYARD	G+150				
VOYAGE	G+250				
WATERBORN BY KVADRAT	G+300				
WAXEN	F				
WEDGE	G				
WHIRL	F				
WOOL RIB	G+200				
WOOL STRIAE	CALL				
WOOL VELVET	CALL				
WRAP	F				

√: CURRENT CARDED FABRIC
*: PATTERNS OR COLORS BEING PHASED OUT

fabric program

For memo samples or availability call Momentum at 800.366.6839

MOMENTUM TEXTILES

√: CURRENT CARDED FABRIC
*: PATTERNS OR COLORS BEING PHASED OUT

PATTERN	PATTERN	C.C.F.	PATTERN	PATTERN	C.C.F.	PATTERN	PATTERN	C.C.F.
ACE	D		CENTRIC	G		EXTEND	C	
ACOUSTIC	G		CHANNEL	E		FELIZ	G	
AGORA II	D		CHIPPER	G		FLECTION	G	
ALDO	G+\$100		CINCH	C		FLEET	F	
ALIGN	G		CITE	G		FLOW	G	
ALLEGORY	G		CLANG	D		FLUENT	E	
ALMANAC	G+\$50		CONTEXT	C		FLUX	G+\$50	
ALPHA	C		CORE	B		FOCAL	D	√
AMENITY II	G		COURSE	G		FOOTLIGHTS	C	
AMUSE	D	√	COVER CLOTH	D		FORAY	E	
ANNEX	C		CROSSING COLORS	G+\$100		FREE	C	√
APRIL	F		CRYPTIC	G		FREEHAND	E	
ARDOUR II	G		CURRENT		√ √	FRINGE	F	
ARRANGE	G+\$50		CURTAIN CALL	C		FUSE	B	√
ASCEND	F		CYCLE	E		GEO	G+\$50	
AUDIO	G		DASH	G		GLINT	D	
AUDUBON	G+\$50		DAYSPELL	G		GOLDEN LEAF TREE	F	
AVANTI	G		DECODE	C	√	GRADUAL	E	
AVENUE	E		DELVE	F		GROOVE	E	
AXIS	B		DIVE	F		HABIT	D	
BACKDROP	C		DIVIDEND	G+\$50		HAIKU	E	
BANDWIDTH II	G		DOCKET	G+\$50		HEARSAY	G	
BANGLE	B	√	DOGWOOD LEAVES	F		HELM	G	
BANTER	G+\$50		DOMAIN	F		HICKORY LEAF	E	
BASIS	C		DRAWING LINES	G+\$50		HIVE	F	
BEELINE	C	√	DRIFT	G		HUE	C	√
BEEP	D	√	DUO	G		HULA	G	
BENTO	G		EBB	G+\$50		ICON	F	
BETULA	E		ECHO II	G		IDENTITY	G	
BIAS	G		EDICT	C		IDYLL	G	
BLOC	G+\$50		EDISON	G		IMPACT	D	
BOOM II	D		EFFLORESCE	G+\$50		INDEX	G+\$50	
BOXCAR	G		ELEVATE	G+\$50		INFINITY	D	
BRAVO II	E		ELLE	G		INFUSION	G	
BRISK	G		EMANATE	G+\$50		INLAY	E	
BUOY	G		EMBARK	F		INNER CIRCLE	G+\$50	
CAIRNS	G+\$50		ENCORE	C		INSIGHT	B	√
CAMBER	G		EON	D		INTERIM	G	
CAMEO	C		EPIC	C	√	INTERMEZZO	G+\$50	
CANTER	B	√	ESSAY	G		INTERMIX II	E	
CARLO	G+\$100		ESTRELLA	G		INTERSECT	E	
CASHMERE II	B		ETUDE	G+\$50		INTERVAL	B	
CATALOGUE	G+\$50		EVOLVE	G		ISLA	F	
CENTRAL	F		EXPO	C		JARDIN	G	

√: CURRENT CARDED FABRIC
*: PATTERNS OR COLORS BEING PHASED OUT

PATTERN	PATTERN	C.C.F.	PATTERN	PATTERN	C.C.F.	PATTERN	PATTERN	C.C.F.
JEST	G		PACE CRYPTON	F		SIDESTEP	G	
JITNEY	F		PACE INCASE	E		SILICA	F	√
JOYN	E		PACT	C		SILICA ANDY	G+\$150	
JUNCTURE	G+\$50		PAINTING STROKES	G+\$50		SILICA COMPASS	G+\$150	
KAYAK	G+\$50		PANORAMA	G		SILICA CUSP	G+\$150	
KEYNOTE	E		PARABLE	G		SILICA DEFLECT	G+\$150	
KINDLE	F		PARAGON	F		SILICA EFFLORESCE	G+\$150	
KINDRED	F		PARKSIDE CRYPTON	F		SILICA ETCH	G	
KINECT	D		PARKSIDE INCASE	E		SILICA FIONA	G+\$150	
KINNEY	E		PARTERRE	F		SILICA FRITZ	G+\$150	
KNACK	C	√	PERENNIAL	F		SILICA HIATUS	G+\$150	
KUDOS	G		PERK	C		SILICA HOOP	G+\$150	
LEDGE	E		PHASE	G+\$50		SILICA LEATHER	G	
LELLA	G+\$50		PHOTON	G		SILICA MOTIVE	G+\$150	
LEVEL	G		PIERRE	G+\$100		SILICA REACH	G+\$150	
LINA	G+\$50		PING	E		SILICA ROAM	G+\$150	
LINEUP	D		PIQUE	E		SILICA SCOUT	G+\$150	
LIVIA	G+\$50		PROPENSITY II	C	√	SILICA STRIDE	G+\$150	
LLOYD	G+\$100		PROSPECT	F		SILICA TECH	G	
LORE	G		PROVERB	D		SILICA WALTZ	G+\$150	
LUCIO	G+\$150		PROXIMITY	G+\$50		SKETCHING AIR	G+\$50	
LUDWIG	G+\$100		QUIRK	E		SKIP	D	
MALMO	G+\$50		RALLY	G		SMALL TALK	G	
MAPPING IDEAS	G+\$50		RECOLLECTION II	G		SOLACE	E	
MARATHON	D		REDUX	E		SOLARIS	E	
MARCEL	G+\$50		REFRACT	G		SOLO2	E	
MAX	E		REIN II	E		SOMA	G	
MEANDER	C		RESPITE	E		SONOMA	E	
MEDLEY	E		REVOLVE	G+\$50		SORT	G	
MENSA	G		RIGA	G+\$50		SPAN CRYPTON	F	
MIDLANDS	E		RIVET	E		SPAN INCASE	E	
MILLENNIUM	D		ROSTER	G+\$50		SPIN	G	
MIX	G		ROW	D	√	STARBOARD	G	
MOLTO	G+\$50		SAGA	C		STREAMERS	E	
NAGOYA	G+\$50		SAIL	G		STRUT	E	
NAPA	E		SCAN	G		SUBLIME II	E	
NEON	G		SCAPE	G		SWAY II	G	
NIFTY	E		SCRABBLE	E		SYMBOL	G+\$50	
NIMBLE	G+\$50		SCRIBE	E		SYNERGY	E	
OATH	F		SCRIPT	D		SYNTAX	C	√
ODYSSEY	D		SENSE	F		TACT II	G	
OHS II	G+\$50		SERENDIPITY II	E		TACTIC	G+\$50	
ORIGIN	B	√	SIDEBAR CRYPTON	F		TENOR	C	
OVERTURE	C		SIDEBAR INCASE	E		TESLA	G	

customer material program

com = customer's own material
col = customer's own leather

Ordering Instructions

Contact customer service for inquiries regarding COM/COL or follow the instructions below to assure the best results to produce your COM/COL order.

1. Complete 9to5 Seating COM/COL form (see opposite page or download from website) and send it to 9to5 Seating along with fabric sample.
2. All COM/COL fabrics must be approved by 9to5 Seating and will not be scheduled for production until the entire yardage/ square footage requirements have been received. Approval can be completed by 9to5 Seating in 24 hours. 9to5 Seating will not return any excess COM/COL material.
3. For non-directional, plain, solid colors or non-patterned fabrics, please follow COM yardage requirements as specified under each individual model number in our price list. For fabrics which require special application or direction, please attach a sample of the COM fabric to our COM form. Include all information and return to 9to5 Seating at address shown below.
4. **All COM textiles received at 9to5 Seating must be clearly marked with customer's name, purchase order number, 9to5 Seating sales order number (if available) and any special instructions for application of textile.**

Send fabric to:
9to5 Seating
Attn: COM Fabric Receiving
3211 Jack Northrop Ave.
Hawthorne, CA 90250

5. Upon receipt of COM textile, a production date will be given to the order and you will receive an acknowledgement by fax or e-mail.

Notes:

1. The yardage figures shown throughout the price list are estimates only. Calculations are based on 54" wide material with no repeat and cut in the woven way cutting direction for a single chair. For specific yardage based on width of material, chair model, and quantity, please contact 9to5 Seating.
2. For large quantity orders please contact customer service for more precise yardage requirement. Actual yardage requirement per chair often decreases with larger orders.

Notes (Continued):

3. To calculate COM yardage, use the chart below as a guide and add appropriate amounts to the generic yardage requirements listed in the pricer

FABRIC		2"-14"	15"-27"	28"-36"
WIDTH	GENERIC YARDAGE	REPEAT	REPEAT	REPEAT
54"		+20%	+30%	+40%

4. COL: Leather quality can vary depending on the size of the hides. Larger hides (50 to 60 SQ FT) tend to be higher quality and yield. Smaller hides (40 to 50 SQ FT) tend to have more quality issues that may cause smaller yields, requiring the need for additional hides to be ordered
5. For all COL orders, 9to5 Seating cannot take responsibility for the need to order additional COL due to quality issues and related small material yields

PLEASE SEND A COMPLETED PHOTOCOPY OF THIS PAGE TO 9TO5 SEATING

DATE:	ACCOUNT NUMBER:
DEALER NAME:	PURCHASE ORDER NUMBER:
ADDRESS	CITY/ZIP CODE
9TO5 ORDER NUMBER (IF AVAILABLE)	PHONE NUMBER
MODEL NUMBER	DEALER CONTACT
QUANTITY	

TEXTILE INFORMATION

MILL	FABRIC NAME/NUMBER
FABRIC COLOR	TOTAL YARDAGE SHIPPED

APPLICATION

IS THERE A DESIRED TOP AND BOTTOM TO THE FABRIC?	IS THE FABRIC STRIPE OR TWO-COLOR PLAID?
YES NO	YES NO

CHECK APPROPRIATE BOX FOR YOUR CHOICE OF FABRIC DIRECTION

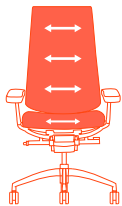
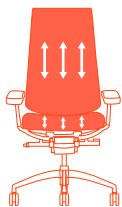
<p>HORIZONTAL</p> <input type="checkbox"/> 	<p>TOP</p> <p>ATTACH SAMPLE TEXTILE HERE WITH DESIRED FACE AND DIRECTION DISPLAYED. IF THERE IS A PATTERN OR REPEAT, THE SAMPLE SHOULD BE LARGE ENOUGH TO SHOW ENTIRE REPEAT.</p> <p>BOTTOM</p>
<p>VERTICAL</p> <input type="checkbox"/> 	

CAL TB 133 fire code

9to5 Seating's entire line of office seating meets California Technical Bulletin 117-2013 (CAL TB 117-2013) which has been in effect since January 1, 2015. This is a standard by which upholstered furniture has been tested for approval to meet a minimum fire standard. 9to5 Seating's standard product is not designed to meet California Technical Bulletin 133. However, upon special request, most 9to5 Seating products can be manufactured to meet the California Technical Bulletin 133 (CAL TB 133).

CAL TB 133

CAL TB 133 is the standard of furniture flammability required by the California Bureau of Home Furnishings and Thermal Insulation for furniture used in public buildings. New requirements proposed for furniture used in public buildings such as:

Healthcare Facilities, Convalescent Homes, Public Assembly Areas of Hotels and Motels, Hospitals, Board and Care Homes, Stadiums, Licensed Child Care Facilities, Prisons and Jails

CAL TB 133 Test

CAL TB 133 is a full scale fire test for furniture manufactured for use in public buildings. The standards do not specify how to construct furniture, but only how it should perform when tested by the following procedures:

A finished piece of furniture, never single components, is placed in a 10' x 12' x 8' chamber and is tested by applying a gas flame for 80 seconds. Then measurements are taken for the rate and amount of heat generated, temperature of the test room while furniture is burning, smoke capacity, amount of carbon monoxide generated and mass loss of the furniture for one hour or until the fire is completely extinguished.

A solution to pass this fire standard test is to sandwich a fire blocking liner between the foam and fabric of our chairs. This liner acts as a 'fire extinguisher' by smothering the flame. As a response to CAL TB 133, and in order to meet customer's needs, 9to5 Seating has designed a variety of models and fabrics that can be combined to meet this new standard.

CAL 133 Models

The following models when combined with approved textiles and blocker meet the CAL 133 standard: All plastic models of Shuttle and Bella are also approved.

Agent: 1425, 1426, 1428, 1660, 1666, 1668

Aria: 1860, 1866, 1868, 1880

Bella: 1310, 1315, 1320, 1325, 1326, 1328, 1360, 1365, 1370, 1375, 1376, 1378

Bristol: 2360, 2366, 2368, 2380

Cayman: 2800, 2800-GT, 2810

Cortina: 2900, 2900-GT, 2910

Cosmo: 3250, 3260, 3250-GT

Cydia: 3300, 3300-GT, 3310, 3310-GT, 3306, 3308, 3315, 3316

Enduro: 1960, 1966, 1968, 1980

Kelley: 1060, 1066, 1070, 1076

Link: 1410, 1415

Logic: 1760, 1766, 1768, 1780, 1790

Precept: 1725, 1726, 1728, 1725-GT

Shuttle: 1210, 1215, 1250

Strata: 1545, 1546, 1548, 1555, 1560, 1565, 1580, 1585, 1560-GT, 1566, 1568, 1561, 1563

Vault: 1460, 1466, 1468

Vesta: 3060, 3061, 3063, 3065, 3066, 3068, 3080, 3085

COM CAL TB 133

COM compliance for CAL 133 models listed above can be determined by specifying upholstery with the exact characteristics as approved 9to5 Seating fabrics or by conducting a full chair burn test. The non-discountable test fee for each chair-fabric combination is \$500.00 net.

CAL TB 133 Upcharge

- 1 - 49 chairs: \$100 List Upcharge
- 50 + chairs: \$50 List Upcharge

To Order CAL TB 133

Clearly specify CAL TB 133 on order, choose your desired fabric, from options above, then add the indicated amount above to the standard list price. Standard lead times apply.

To Check Purchased Seating For CAL 133

To determine whether your current 9to5 Seating chair meets CAL TB 133, or to check an order you have recently received, check the bottom of the chair seat pan for the label shown below.

If your chair does not show this tag below, then your chair does NOT meet CAL TB 133

NOTICE

This article is manufactured for use in public occupancies and meets the flammability requirements of California Bureau of Home Furnishings Technical Bulletin 133. Care should be exercised near open flame or with burning cigarettes.

two tone option

Ordering Instructions

Two Tone Contrasting Seat and Back

When the seat and back fabric or vinyl are different on a single chair, clearly indicate your selection for each on your purchase order. If the two selections are from different grades, price the chair(s) at the higher of the two grades.

Available on:

Agent, Bella, Brio, Bristol, Core, Enduro, Logic, Precept and Shuttle.

DATE:
DEALER NAME:
DEALER CONTACT:
PO NUMBER
1. BACK FABRIC
2. SEAT FABRIC

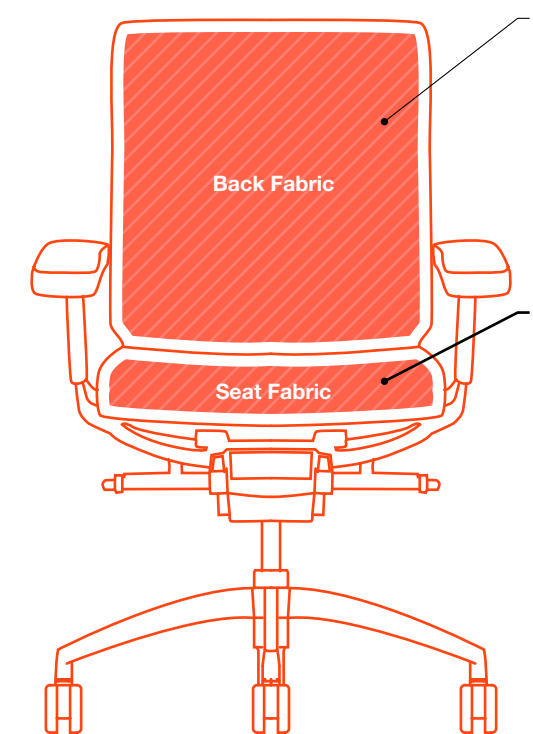

custom embroidery form

Custom embroidery is a great way to display your company logo on upholstered chair backs. Embroidery can be done in multiple colors, shapes and size to suit your needs for a very reasonable cost and lead-time. To obtain a quote for embroidered upholstery, please fill out the adjacent form completely as possible. You will need a graphic file, preferable in Ai, EPS or other graphic format. Generally, higher resolution art (greater than 300 dpi) will be easier to work with. There will be a set-up charge to create a digitized file if you do not have one available. We will also need a PMS color number for each color thread required. 9to5 is not responsible for poorly digitized files or graphic files from the requestor. If the logo is NOT to be in the back center; the location of the logo needs to be specified as an offset from the center of the back, vertically and horizontally. (see form)

Keep in mind, embroidery is not a one to one replacement for printing, patches or heat transfer vinyl lettering. Embroidery thread is heavier, stronger and tighter density than the surrounding fabric and may pull or pucker on loosely woven fabric. Embroidery will always look best on strong, closely knit fabrics or vinyl. It is best to always get a sample for approval before placing the full production order.

All logos are trademarks of their respective owners. 9to5 Seating is not responsible for obtaining permission or use of copyrighted logos. Before you use, reproduce or distribute in any manner you must first receive the express permission of the holder of the copyright or trademark of that logo. Failure to obtain such permission is a violation under international law.

Note: Dimensional tolerance of logo placement is $\pm 1/2"$ vertical and $\pm 1/4"$ horizontal.

PLEASE SEND A COMPLETED PHOTOCOPY OF THIS PAGE TO 9T05 SEATING

FILLABLE FORMS LOCATED ON 9T05SEATING.COM/DOWNLOADS

DATE:	ACCOUNT NUMBER:
DEALER NAME:	PURCHASE ORDER NUMBER:
DEALER CONTACT NAME:	CITY/ZIP CODE
PROJECT(END-USER):	PHONE NUMBER
MODEL NUMBER	DEALER CONTACT
TOTAL PROJECT QUANTITY	TOTAL PROJECT NET:

COMMENTS:

IS THE EMBROIDERY FOR A BID ?		IS A SAMPLE REQUIRED FOR CUSTOMER REVIEW PRIOR TO PRODUCTION OF ORDER?	
YES	NO	YES	NO

IS A LOGO/GRAPHIC FILE AVAILABLE?		LOGO/GRAPHIC FILE TYPE?					
YES	NO	AI	EPS	PDF	JPEG	PNG	OTHER:

STANDARD MODEL	QTY	HEIGHT	WIDTH	COLOR/PMS EQUIVALENT	TEXTILE MILL/PATTERN/COLOR

LOGO/IMAGE LOCATION (FROM LOGO CENTER TO CHAIR BACK CENTER)

VERTICAL OFFSET FROM CENTER: INCHES	HORIZONTAL OFFSET FROM CENTER: INCHES
--	--

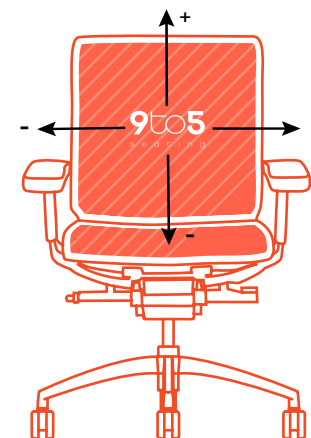

TOP
ATTACH SAMPLE LOGO/GRAPHIC HERE.
BOTTOM

new for 2017!

9to5 explodes into 2017 with 5 dynamic new seating series including multiple lounge seating with suspension tables, enhancements to several existing series and 3 new control options

sophie

ultimate comfort in a complete line of lounge seating

- Thick molded foam seat and back
 - Robust design for the most rigorous public areas
 - 6 powder coat frame colors
 - 7 Connecting and suspension table options
- See page 182



8111

2260

JANUARY 2017

core

contemporary lines for your workspace

- Stylish durable poly outer back
 - Weight balanced or knee tilt Synchro control
 - Optional seat slider
- See page 96

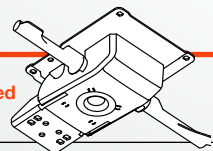

W1 Weight Balanced (for Core)

Auto-Balance tension adjustment utilizes the weight of the user to balance resistance of back. 3:1 back to seat synchronous movement with 2 position back lock. See page 242

zoom

rapid set up for a crew or a crowd

- Training, task, multipurpose, stool, management and conference seating
 - Choice of plastic or upholstered seat
 - 2 powder coated frame finishes
 - 5 stock laminate colors
 - 2 plastic color finishes
- See page 224



MARCH 2017

1115

JANUARY 2017

acclaim

contemporary european styling with subtle detailing

- Weight balance or Synchro control with independent back angle adjustment available
 - New polished arm style with upholstered caps
 - Many standard arm options also available
- See Page 36



2780

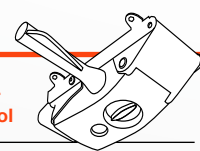

W2 Weight Balanced - Back Travel Control

Auto-Balance tension adjustment utilizes the weight of the user to balance resistance of back. Sensing can be adjusted to suit individual preference with 4 position back-travel limiting lock. **For Acclaim** See page 242

diddy

dazzle your conference space

- Classic styling to impact conference space
 - Chrome wraparound arms
 - Polished high profile base
- See page 122



JANUARY 2017

2450

cydia

now fully upholstered!

- Task Stool, Conference, and Lounge
 - Choice of 3 frame colors
 - 14 mesh colors
- See page 116



cosmo

all new mesh & all new thin back!

- Pneumatic Seat Height Adjustment
 - Side Adjustable Tilt Tension Control
 - Back and Seat Tilt in 2:1 Ratio
 - 11 Locking Positions
- See page 102



Shuttle (Stool Height)

the ultimate utility chair

- Upholstered seat and back
 - 11 plastic colors
 - 2 frame finishes
 - Three Seat Height Choices: 24", 27" & 30"
- See page 164



No more waiting for items built-to-order. Service quick turn jobs and orders with immediate in-stock items that are ready to ship. When fast just isn't good enough. Normal delivery in 4 business days or less from the location nearest you. See page 230

Y5 Full Synchro - Paddle (for Core and Acclaim)

Enjoy the ride with this high function full 2:1 synchro control featuring an independent back angle adjustment, 4 position back lock, side tension control and built in seat slider depth adjustment. See page 243

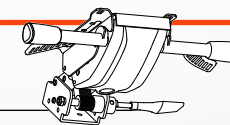

A27 CHROME CANTILEVER ARM

The fixed arm offers a smooth polished aluminum surface with padded upholstered cap in an attractive cantilever style design. See page 233

acclaim

contemporary european styling yet subtle detailing

NEW HIGH-BACK

GSA SIN # 711-18 Pending

- Weight balance or synchro control
- Synchro with independent back angle adjustment available
- New polished arm style with upholstered caps
- Many standard arm options also available
- Great addition for conference or executive
- Standard black nylon high profile base
- Rated for 300 lbs.



CREATING ACCLAIM MODEL NUMBER

MODEL NUMBER CONTROL ARMS GRADE CASTERS PACKAGING OPTIONS
 2 7 8 0 - [] [] - A [] [] - [] [] - [] [] [] [] - [] [] [] []

* GT MODELS DO NOT HAVE A CASTER CODE

PACKAGING NOTES

CODE	DESCRIPTION	LIST UPCHARGE
AB	ASSEMBLED IN BAG FOR WILL CALL	\$0
PAC	PARTIALLY ASSEMBLED IN CARTON	\$0
BAC	BACK ASSEMBLED IN CARTON	\$40

MODEL	CONTROL	DESCRIPTION	ARM	FABRIC	A/COM	B	C	D	E	F	G	L3/COL	L4	L5
NEW MODEL 2780	W2	HIGH-BACK WEIGHT BALANCED Use for a variety of general office seating, including private office and conference room seating.	ARMLESS		495	550	585	640	700	770	845	675	720	940
			A10		580	635	670	725	785	855	930	760	805	1025
			A19		695	750	785	840	900	970	1045	875	920	1140
			A27		675	730	765	820	880	950	1025	855	900	1120
			A36		600	655	690	745	805	875	950	780	825	1045
			A37		620	675	710	765	825	895	970	800	845	1065

SEAT SLIDER (SS) - NOT AVAILABLE WITH W2

FEATURES

- Pneumatic Seat Height Adjustment
- Weight Balanced Control with Body Adjust
- 4 Back Recline Limit Positions
- Rated for 300 lbs

DIMENSIONS

WIDTH: 27.3
 DEPTH: 26.5
 HEIGHT: 44.50-49.00
 SEAT WIDTH: 20.0
 SEAT DEPTH: 17.0
 SEAT HEIGHT: 17.25-21.75
 BACK WIDTH: 21.3
 BACK HEIGHT: 44.3
 COM: 1.7 YD
 COL: 27 SQ FT
 WEIGHT: 44.0 LB

ARM OPTIONS

<p>A10 \$85</p> <p>Soft Touch Cantilever style C-Shaped Arm</p>	<p>A19 \$200</p> <p>Polished Aluminum C-Shape Arm</p>	<p>A27 \$180</p> <p>Polished Aluminum C-Shape Arm with matching upholstered pad</p>
<p>A36 \$105</p> <p>8-Way Adjustable Arms Soft-Touch sliding and pivoting arm pads.</p>	<p>A37 \$125</p> <p>10-Way Adjustable Arms Soft-Touch sliding and pivoting arm pads with 4" arm width adjustment activated via knob under seat.</p>	

MODEL	CONTROL	DESCRIPTION	ARM	FABRIC	A/COM	B	C	D	E	F	G	L3/COL	L4	L5
NEW MODEL 2780	Y2	HIGH-BACK HEAVY DUTY SYNCHRO TILT CONTROL Use for a variety of general office seating, including private office and conference room seating.	ARMLESS		555	610	645	700	760	830	905	735	780	1000
			A10		640	695	730	785	845	915	990	820	865	1085
			A19		755	810	845	900	960	1030	1105	935	980	1200
			A27		735	790	825	880	940	1010	1085	915	960	1180
			A36		660	715	750	805	865	935	1010	840	885	1105
			A37		680	735	770	825	885	955	1030	860	905	1125

SEAT SLIDER (SS) - ADD \$60

- Pneumatic Seat Height Adjustment
- Side Tension Control
- Synchro Control
- 4 Position Back Lock
- Rated for 300 lbs

WIDTH: 27.3
 DEPTH: 26.5
 HEIGHT: 44.50-49.00
 SEAT WIDTH: 20.0
 SEAT DEPTH: 17.0
 SEAT HEIGHT: 17.25-21.75
 BACK WIDTH: 21.3
 BACK HEIGHT: 44.3
 COM: 1.7 YD
 COL: 27 SQ FT
 WEIGHT: 44.0 LB

CASTER OPTIONS

<p>C6 \$60</p> <p>Standard with BA11 60mm Hoodless Casters</p>	<p>C6S \$35</p> <p>60mm Hoodless Hard Floor Casters</p>	<p>C7 \$35</p> <p>60mm Chrome Accented Hoodless Casters Standard with Polished Base.</p>
---	--	---

MODEL	CONTROL	DESCRIPTION	ARM	FABRIC	A/COM	B	C	D	E	F	G	L3/COL	L4	L5
NEW MODEL 2780	Y5	HIGH-BACK ADJUSTABLE BACK FULL SYNCHRO TILT CONTROL High function full synchro control with independent back angle adjust. Use for general office, task, or management.	ARMLESS		575	630	665	720	780	850	925	755	800	1020
			A10		660	715	750	805	865	935	1010	840	885	1105
			A19		775	830	865	920	980	1050	1125	955	1000	1220
			A27		755	810	845	900	960	1030	1105	935	980	1200
			A36		680	735	770	825	885	955	1030	860	905	1125
			A37		700	755	790	845	905	975	1050	880	925	1145

SEAT SLIDER (SS) - STANDARD

- Pneumatic Seat Height Adjustment
- Synchro with Independent Back Angle Lock
- 4 Back Locking Positions
- Side Tension Control
- Standard Seat Slider Adds 3" Adjustment
- Rated for 300 lbs

WIDTH: 27.3
 DEPTH: 26.5
 HEIGHT: 44.50-49.00
 SEAT WIDTH: 20.0
 SEAT DEPTH: 17.0
 SEAT HEIGHT: 17.25-21.75
 BACK WIDTH: 21.3
 BACK HEIGHT: 44.3
 COM: 1.7 YD
 COL: 27 SQ FT
 WEIGHT: 44.0 LB

ADDITIONAL OPTIONS

<p>SS \$60</p> <p>Seat Slider 2.5" Side Paddle Activated (for Models with Y2 Control)</p>	<p>BA11 STD</p> <p>27" Mid-Profile Black Plastic Base</p>	<p>BA12P \$100</p> <p>27" High Profile Polished Aluminum Base</p>
--	--	--

AVAILABLE JANUARY 2017

agent

lending comfort, durability and value to every project

GSA SIN # 711-18

- Task, stool, and conference seating
- Ratchet back height adjustment on P1, R1, M1, and Y2 models
- Warranted up to 250 lbs with B2, S2, R1, P1
- Warranted up to 300 lbs with M1, Y2
- CAL TB 133 Fire Code approved



LOW-BACK

CREATING AGENT MODEL NUMBER

MODEL NUMBER CONTROL ARMS GRADE CASTERS PACKAGING OPTIONS

1 4 2 5 - - A - - C - - - -

* FOR ARMLESS CODE USE A00

PACKAGING NOTES

CODE	DESCRIPTION	LIST UPCHARGE
AB	ASSEMBLED IN BAG FOR WILL CALL	\$0
PAC	PARTIALLY ASSEMBLED IN CARTON	\$0
BAC	BACK ASSEMBLED IN CARTON	\$40

MODEL	CONTROL	DESCRIPTION	ARM	FABRIC							FEATURES	DIMENSIONS	ARM OPTIONS		
				A/COM	B	C	D	E	F	G					
1425	B2	LOW-BACK BASIC CONTROL Our basic control has simple adjustments. Ideal for clerical, casual meetings, and general office use.	ARMLESS	275	300	320	345	375	410	445		<ul style="list-style-type: none"> • 360 Degree Swivel • Pneumatic Seat Height Adjustment • Adjustable Back Depth • Rated for 250 lbs 	WIDTH: 27.0 DEPTH: 26.5 HEIGHT: 31.5-36.0 SEAT WIDTH: 19.5 SEAT DEPTH: 15.5 SEAT HEIGHT: 17.5-22.0 BACK WIDTH: 16.5 BACK HEIGHT: 16.5 COM: 0.8 YDS WEIGHT: 33.0 LB	A1 \$70 Black soft touch loop arm	A4 \$75 A4, 2-way adjustable arm for height A5 \$95 A5, 4-way adjustable arm for height and width A6 \$130 The A6 arm with Ura-Soft® arm pads, locking height adjustment, swivel pad, and adjustable arm pad position, A7 \$150 A7 adds 4" arm width adjustment knob under seat.
			A1	345	370	390	415	445	480	515					
			A4	350	375	395	420	450	485	520					
			A5	370	395	415	440	470	505	540					
			A6	405	430	450	475	505	540	575					
			A7	425	450	470	495	525	560	595					
			A16	375	400	420	445	475	510	545					
1425	S2	LOW-BACK SWIVEL TILT CONTROL Use for a variety of general office seating, including private office and conference room seating.	ARMLESS	320	345	365	390	420	455	490		<ul style="list-style-type: none"> • Pneumatic Seat Height Adjustment • Tilt Tension Control • Seat and Back Tilt as a Unit • Upright Position Tilt Lock • Adjustable back depth • Rated for 250 lbs 	WIDTH: 27.0 DEPTH: 26.5 HEIGHT: 31.5-36.0 SEAT WIDTH: 19.5 SEAT DEPTH: 15.5 SEAT HEIGHT: 17.5-22.0 BACK WIDTH: 16.5 BACK HEIGHT: 16.5 COM: 0.8 YDS WEIGHT: 35.0 LB	A16 \$100 Black Soft Touch C-Shape Arm w/ Upholstered Pad 1/2 inch thick and 13" long	A36 \$105 8-Way Adjustable Arms Soft-Touch sliding and pivoting arm pads. A37 \$125 10-Way Adjustable Arms Soft-Touch sliding and pivoting arm pads with 4" arm width adjustment activated via knob under seat.
			A1	390	415	435	460	490	525	560					
			A4	395	420	440	465	495	530	565					
			A5	415	440	460	485	515	550	585					
			A6	450	475	495	520	550	585	620					
			A7	470	495	515	540	570	605	640					
			A16	420	445	465	490	520	555	590					
1425	P1	LOW-BACK POSTURE BACK CONTROL The articulating back provides proper support for moderate tasking applications.	ARMLESS	360	385	405	430	460	495	530		<ul style="list-style-type: none"> • Pneumatic Seat Height Adjustment • Infinite back angle adjust with free float • Back Tilt Adjustment • Ratchet Back Height Lumbar Adjustment • Rated for 250 lbs 	WIDTH: 27.0 DEPTH: 26.5 HEIGHT: 31.5-39.0 SEAT WIDTH: 19.5 SEAT DEPTH: 15.5 SEAT HEIGHT: 17.5-22.0 BACK WIDTH: 16.5 BACK HEIGHT: 16.5-19.5 COM: 0.8 YDS WEIGHT: 37.0 LB	C1 STD 50mm Hooded Casters C1S \$35 50mm Hooded Hard Floor Casters C2S \$35 50mm Hooded Self-Locking Hard Floor Casters	
			A1	430	455	475	500	530	565	600					
			A4	435	460	480	505	535	570	605					
			A5	455	480	500	525	555	590	625					
			A6	490	515	535	560	590	625	660					
			A7	510	535	555	580	610	645	680					
			A16	460	485	505	530	560	595	630					
1425	R1	LOW-BACK ROCKING CONTROL For managerial and task applications. Similar to a swivel tilt control, with the added comfort of infinite back angle and tilt adjustment.	A37	370	395	415	440	470	505	540		<ul style="list-style-type: none"> • Pneumatic Seat Height Adjustment • Tilt Tension Control • Seat and Back Tilt as a Unit • Floating Seat Position Tilt Lock • Infinite Back Angle Adj w/ Free Float • Ratchet Back Height Lumbar Adjustment • Rated for 250 lbs 	WIDTH: 27.0 DEPTH: 26.5 HEIGHT: 31.5-36.0 SEAT WIDTH: 19.5 SEAT DEPTH: 15.5 SEAT HEIGHT: 17.5-22.0 BACK WIDTH: 16.5 BACK HEIGHT: 16.5 COM: 0.8 YDS WEIGHT: 33.0 LB	BT \$15 Replace Knob with Bolt (for B2 or S2 Controls ONLY) EF1 \$30 1" extra foam on seat MF1 \$50 1" Visco elastic memory foam on seat	
			ARMLESS	440	465	485	510	540	575	610					
			A1	445	470	490	515	545	580	615					
			A4	465	490	510	535	565	600	635					
			A5	500	525	545	570	600	635	670					
			A6	520	545	565	590	620	655	690					
			A7	470	495	515	540	570	605	640					
A16	475	500	520	545	575	610	645								
A36	475	500	520	545	575	610	645								
A37	495	520	540	565	595	630	665								

agent

lending comfort, durability and value to every project

GSA SIN # 711-18

- Task, stool, and conference seating
- Ratchet back height adjustment on P1, R1, M1, and Y2 models
- Warranted up to 250 lbs with B2, S2, R1, P1
- Warranted up to 300 lbs with M1, Y2
- CAL TB 133 Fire Code approved



LOW-BACK

CREATING AGENT MODEL NUMBER

MODEL NUMBER CONTROL ARMS GRADE CASTERS PACKAGING OPTIONS

1 4 2 5 - - A - - C - - - -

* FOR ARMLESS CODE USE ADD

PACKAGING NOTES

CODE	DESCRIPTION	LIST UPCHARGE
AB	ASSEMBLED IN BAG FOR WILL CALL	\$0
PAC	PARTIALLY ASSEMBLED IN CARTON	\$0
BAC	BACK ASSEMBLED IN CARTON	\$40

MODEL	CONTROL	DESCRIPTION	ARM	FABRIC	FEATURES	DIMENSIONS	ARM OPTIONS	CASTER OPTIONS	ADDITIONAL OPTIONS	
1425	M1	LOW-BACK MULTI-FUNCTION CONTROL Fully articulating seat and back for the highest level of ergonomic needs. Forward seat pitch adjustment from 0 to 6 degrees.	ARMLESS A1 A4 A5 A6 A7 A16 A36 A37	A/COM B C D E F G	<ul style="list-style-type: none"> • Pneumatic Seat Height Adjustment • Tilt Tension Control • Seat and Back Tilt as a Unit • Floating Seat Position Tilt Lock • Infinite Back Angle Adj w/ Free Float • Seat Pivots from 0° to 6° Forward • Ratchet Back Height Lumbar Adjustment • Rated for 300 lbs. 	WIDTH: 27.0 DEPTH: 26.5 HEIGHT: 31.5-39.0 SEAT WIDTH: 19.5 SEAT DEPTH: 15.5 SEAT HEIGHT: 17.5-22.0 BACK WIDTH: 16.5 BACK HEIGHT: 16.5-19.5 COM: 0.8 YDS WEIGHT: 43.0 LB	A1 \$70 Black soft touch loop arm A4 \$75 A5 \$95 A4, 2-way adjustable arm for height A5, 4-way adjustable arm for height and width A6 \$130 A7 \$150 The A6 arm with Ura-Soft® arm pads, locking height adjustment, swivel pad, and adjustable arm pad position, A7 adds 4" arm width adjustment knob under seat.	A16 \$100 Black Soft Touch C-Shape Arm w/ Upholstered Pad 1/2 inch thick and 13" long A36 \$105 8-Way Adjustable Arms Soft-Touch sliding and pivoting arm pads. A37 \$125 10 -Way Adjustable Arms Soft-Touch sliding and pivoting arm pads and 4" arm width knob under seat.	C1 STD 50mm Hooded Casters C1S \$35 50mm Hooded Hard Floor Casters C2S \$35 50mm Hooded Self-Locking Hard Floor Casters	BT \$15 Replace Knob with Bolt (for B2 or S2 Controls ONLY) EF1 \$30 1" extra foam on seat MF1 \$50 1" Visco elastic memory foam on seat
1425	Y2-SS	LOW-BACK SYNCHRO TILT CONTROL Use for a variety of general office seating, including private office and conference room seating.	ARMLESS A1 A4 A5 A6 A7 A16 A36 A37	A/COM B C D E F G	<ul style="list-style-type: none"> • Pneumatic Seat Height Adjustment • Side Tilt Tension Control • Back and Seat Tilt in 2:1 ratio • 4 Locking Positions • Safety Tilt Release • Ratchet Back Height Lumbar Adjustment • SS Seat Slider standard • Rated for 300 lbs 	WIDTH: 27.0 DEPTH: 26.5 HEIGHT: 31.5-36.0 SEAT WIDTH: 19.5 SEAT DEPTH: 15.5 SEAT HEIGHT: 17.5-22.0 BACK WIDTH: 16.5 BACK HEIGHT: 16.5 COM: 0.8 YDS WEIGHT: 35.0 LB				

agent

lending comfort, durability and value to every project

GSA SIN # 711-18

- Task, stool, and conference seating
- Ratchet back height adjustment on P1
- Warranted up to 250 lbs
- CAL TB 133 Fire Code approved



CREATING AGENT MODEL NUMBER

MODEL NUMBER CONTROL ARMS GRADE CASTERS PACKAGING OPTIONS

1 4 2 - - - A - - - C - - - - -

* FOR ARMLESS CODE USE A00

PACKAGING NOTES

CODE	DESCRIPTION	LIST UPCHARGE
AB	ASSEMBLED IN BAG FOR WILL CALL	\$0
PAC	PARTIALLY ASSEMBLED IN CARTON	\$0
BAC	BACK ASSEMBLED IN CARTON	\$40

LOW-BACK STOOL

MODEL	CONTROL	DESCRIPTION	ARM	FABRIC	FEATURES	DIMENSIONS	ARM OPTIONS																																																																						
1426	B2	10" STOOL BASIC CONTROL Use for work surfaces up to 42 inches high.	ARMLESS	<table border="1"> <thead> <tr> <th>A/COM</th> <th>B</th> <th>C</th> <th>D</th> <th>E</th> <th>F</th> <th>G</th> </tr> </thead> <tbody> <tr><td>400</td><td>425</td><td>445</td><td>470</td><td>500</td><td>535</td><td>570</td></tr> <tr><td>A1</td><td>470</td><td>495</td><td>515</td><td>540</td><td>570</td><td>605</td></tr> <tr><td>A4</td><td>475</td><td>500</td><td>520</td><td>545</td><td>575</td><td>610</td></tr> <tr><td>A5</td><td>495</td><td>520</td><td>540</td><td>565</td><td>595</td><td>630</td></tr> <tr><td>A6</td><td>530</td><td>555</td><td>575</td><td>600</td><td>630</td><td>665</td></tr> <tr><td>A7</td><td>550</td><td>575</td><td>595</td><td>620</td><td>650</td><td>685</td></tr> <tr><td>A16</td><td>500</td><td>525</td><td>545</td><td>570</td><td>600</td><td>635</td></tr> <tr><td>A36</td><td>505</td><td>530</td><td>550</td><td>575</td><td>605</td><td>640</td></tr> <tr><td>A37</td><td>525</td><td>550</td><td>570</td><td>595</td><td>625</td><td>660</td></tr> </tbody> </table>	A/COM	B	C	D	E	F	G	400	425	445	470	500	535	570	A1	470	495	515	540	570	605	A4	475	500	520	545	575	610	A5	495	520	540	565	595	630	A6	530	555	575	600	630	665	A7	550	575	595	620	650	685	A16	500	525	545	570	600	635	A36	505	530	550	575	605	640	A37	525	550	570	595	625	660	<ul style="list-style-type: none"> • 360 Degree Swivel • Pneumatic Seat Height Adjustment • Adjustable Back Depth • Height Adjustable Footring • Rated for 250 lbs 	WIDTH: 27.0 DEPTH: 26.5 HEIGHT: 40.5-50.5 SEAT WIDTH: 19.5 SEAT DEPTH: 15.5 SEAT HEIGHT: 26.5-36.5 BACK WIDTH: 16.5 BACK HEIGHT: 16.5 COM: 0.8 YDS WEIGHT: 38.0 LB	
A/COM	B		C	D	E	F	G																																																																						
400	425	445	470	500	535	570																																																																							
A1	470	495	515	540	570	605																																																																							
A4	475	500	520	545	575	610																																																																							
A5	495	520	540	565	595	630																																																																							
A6	530	555	575	600	630	665																																																																							
A7	550	575	595	620	650	685																																																																							
A16	500	525	545	570	600	635																																																																							
A36	505	530	550	575	605	640																																																																							
A37	525	550	570	595	625	660																																																																							
	P1	10" STOOL POSTURE BACK CONTROL Use for work surfaces up to 42 inches high.	ARMLESS	<table border="1"> <thead> <tr> <th>A/COM</th> <th>B</th> <th>C</th> <th>D</th> <th>E</th> <th>F</th> <th>G</th> </tr> </thead> <tbody> <tr><td>485</td><td>510</td><td>530</td><td>555</td><td>585</td><td>620</td><td>655</td></tr> <tr><td>A1</td><td>555</td><td>580</td><td>600</td><td>625</td><td>655</td><td>690</td></tr> <tr><td>A4</td><td>560</td><td>585</td><td>605</td><td>630</td><td>660</td><td>695</td></tr> <tr><td>A5</td><td>580</td><td>605</td><td>625</td><td>650</td><td>680</td><td>715</td></tr> <tr><td>A6</td><td>615</td><td>640</td><td>660</td><td>685</td><td>715</td><td>750</td></tr> <tr><td>A7</td><td>635</td><td>660</td><td>680</td><td>705</td><td>735</td><td>770</td></tr> <tr><td>A16</td><td>585</td><td>610</td><td>630</td><td>655</td><td>685</td><td>720</td></tr> <tr><td>A36</td><td>590</td><td>615</td><td>635</td><td>660</td><td>690</td><td>725</td></tr> <tr><td>A37</td><td>610</td><td>635</td><td>655</td><td>680</td><td>710</td><td>755</td></tr> </tbody> </table>	A/COM	B	C	D	E	F	G	485	510	530	555	585	620	655	A1	555	580	600	625	655	690	A4	560	585	605	630	660	695	A5	580	605	625	650	680	715	A6	615	640	660	685	715	750	A7	635	660	680	705	735	770	A16	585	610	630	655	685	720	A36	590	615	635	660	690	725	A37	610	635	655	680	710	755	<ul style="list-style-type: none"> • Pneumatic Seat Height Adjustment • Infinite back angle adjust with free float • Ratchet Back Height Lumbar Adjustment • Height Adjustable Footring • Rated for 250 lbs 	WIDTH: 27.0 DEPTH: 26.5 HEIGHT: 40.5-53.5 SEAT WIDTH: 19.5 SEAT DEPTH: 15.5 SEAT HEIGHT: 26.5-36.5 BACK WIDTH: 16.5 BACK HEIGHT: 16.5-19.5 COM: 0.8 YDS WEIGHT: 42.0 LB	
A/COM	B		C	D	E	F	G																																																																						
485	510	530	555	585	620	655																																																																							
A1	555	580	600	625	655	690																																																																							
A4	560	585	605	630	660	695																																																																							
A5	580	605	625	650	680	715																																																																							
A6	615	640	660	685	715	750																																																																							
A7	635	660	680	705	735	770																																																																							
A16	585	610	630	655	685	720																																																																							
A36	590	615	635	660	690	725																																																																							
A37	610	635	655	680	710	755																																																																							
1428	B2	8" STOOL BASIC CONTROL Use for work surfaces up to 36 inches high.	ARMLESS	<table border="1"> <thead> <tr> <th>A/COM</th> <th>B</th> <th>C</th> <th>D</th> <th>E</th> <th>F</th> <th>G</th> </tr> </thead> <tbody> <tr><td>400</td><td>425</td><td>445</td><td>470</td><td>500</td><td>535</td><td>570</td></tr> <tr><td>A1</td><td>470</td><td>495</td><td>515</td><td>540</td><td>570</td><td>605</td></tr> <tr><td>A4</td><td>475</td><td>500</td><td>520</td><td>545</td><td>575</td><td>610</td></tr> <tr><td>A5</td><td>495</td><td>520</td><td>540</td><td>565</td><td>595</td><td>630</td></tr> <tr><td>A6</td><td>530</td><td>555</td><td>575</td><td>600</td><td>630</td><td>665</td></tr> <tr><td>A7</td><td>550</td><td>575</td><td>595</td><td>620</td><td>650</td><td>685</td></tr> <tr><td>A16</td><td>500</td><td>525</td><td>545</td><td>570</td><td>600</td><td>635</td></tr> <tr><td>A36</td><td>505</td><td>530</td><td>550</td><td>575</td><td>605</td><td>640</td></tr> <tr><td>A37</td><td>525</td><td>550</td><td>570</td><td>595</td><td>625</td><td>660</td></tr> </tbody> </table>	A/COM	B	C	D	E	F	G	400	425	445	470	500	535	570	A1	470	495	515	540	570	605	A4	475	500	520	545	575	610	A5	495	520	540	565	595	630	A6	530	555	575	600	630	665	A7	550	575	595	620	650	685	A16	500	525	545	570	600	635	A36	505	530	550	575	605	640	A37	525	550	570	595	625	660	<ul style="list-style-type: none"> • 360 Degree Swivel • Pneumatic Seat Height Adjustment • Adjustable Back Depth • Height Adjustable Footring • Rated for 250 lbs 	WIDTH: 27.0 DEPTH: 26.5 HEIGHT: 35.0-43.0 SEAT WIDTH: 19.5 SEAT DEPTH: 15.5 SEAT HEIGHT: 21.5-29.5 BACK WIDTH: 16.5 BACK HEIGHT: 16.5 COM: 0.8 YDS WEIGHT: 37.0 LB	
A/COM	B		C	D	E	F	G																																																																						
400	425	445	470	500	535	570																																																																							
A1	470	495	515	540	570	605																																																																							
A4	475	500	520	545	575	610																																																																							
A5	495	520	540	565	595	630																																																																							
A6	530	555	575	600	630	665																																																																							
A7	550	575	595	620	650	685																																																																							
A16	500	525	545	570	600	635																																																																							
A36	505	530	550	575	605	640																																																																							
A37	525	550	570	595	625	660																																																																							
1428	P1	8" STOOL POSTURE BACK CONTROL Use for work surfaces up to 36 inches high.	ARMLESS	<table border="1"> <thead> <tr> <th>A/COM</th> <th>B</th> <th>C</th> <th>D</th> <th>E</th> <th>F</th> <th>G</th> </tr> </thead> <tbody> <tr><td>485</td><td>510</td><td>530</td><td>555</td><td>585</td><td>620</td><td>655</td></tr> <tr><td>A1</td><td>555</td><td>580</td><td>600</td><td>625</td><td>655</td><td>690</td></tr> <tr><td>A4</td><td>560</td><td>585</td><td>605</td><td>630</td><td>660</td><td>695</td></tr> <tr><td>A5</td><td>580</td><td>605</td><td>625</td><td>650</td><td>680</td><td>715</td></tr> <tr><td>A6</td><td>615</td><td>640</td><td>660</td><td>685</td><td>715</td><td>750</td></tr> <tr><td>A7</td><td>635</td><td>660</td><td>680</td><td>705</td><td>735</td><td>770</td></tr> <tr><td>A16</td><td>585</td><td>610</td><td>630</td><td>655</td><td>685</td><td>720</td></tr> <tr><td>A36</td><td>590</td><td>615</td><td>635</td><td>660</td><td>690</td><td>725</td></tr> <tr><td>A37</td><td>610</td><td>635</td><td>655</td><td>680</td><td>710</td><td>745</td></tr> </tbody> </table>	A/COM	B	C	D	E	F	G	485	510	530	555	585	620	655	A1	555	580	600	625	655	690	A4	560	585	605	630	660	695	A5	580	605	625	650	680	715	A6	615	640	660	685	715	750	A7	635	660	680	705	735	770	A16	585	610	630	655	685	720	A36	590	615	635	660	690	725	A37	610	635	655	680	710	745	<ul style="list-style-type: none"> • Pneumatic Seat Height Adjustment • Infinite back angle adjust with free float • Ratchet Back Height Lumbar Adjustment • Height Adjustable Footring • Rated for 250 lbs 	WIDTH: 27.0 DEPTH: 26.5 HEIGHT: 35.0-46.0 SEAT WIDTH: 19.5 SEAT DEPTH: 15.5 SEAT HEIGHT: 21.5-29.5 BACK WIDTH: 16.5 BACK HEIGHT: 16.5-19.5 COM: 0.8 YDS WEIGHT: 41.0 LB	
A/COM	B		C	D	E	F	G																																																																						
485	510	530	555	585	620	655																																																																							
A1	555	580	600	625	655	690																																																																							
A4	560	585	605	630	660	695																																																																							
A5	580	605	625	650	680	715																																																																							
A6	615	640	660	685	715	750																																																																							
A7	635	660	680	705	735	770																																																																							
A16	585	610	630	655	685	720																																																																							
A36	590	615	635	660	690	725																																																																							
A37	610	635	655	680	710	745																																																																							

agent

lending comfort, durability and value to every project

GSA SIN # 711-18

- Task, stool, and conference seating
- Ratchet back height adjustment on P1, R1, M1, and Y2 models
- Warranted up to 250 lbs with S2, R1, P1
- Warranted up to 300 lbs with M1, Y2
- CAL TB 133 Fire Code approved



CREATING AGENT MODEL NUMBER

MODEL NUMBER CONTROL ARMS GRADE CASTERS PACKAGING OPTIONS

1 6 6 0 - - A - - C - - - - -

* FOR ARMLESS CODE USE A00

PACKAGING NOTES

CODE	DESCRIPTION	LIST UPCHARGE
AB	ASSEMBLED IN BAG FOR WILL CALL	\$0
PAC	PARTIALLY ASSEMBLED IN CARTON	\$0
BAC	BACK ASSEMBLED IN CARTON	\$40

MID-BACK

MODEL	CONTROL	DESCRIPTION	ARM	FABRIC	FEATURES	DIMENSIONS	ARM OPTIONS	CASTER OPTIONS	ADDITIONAL OPTIONS
1660	B2	MID-BACK BASIC CONTROL Our basic control has simple adjustments. Ideal for clerical, casual meetings, and general office use.	ARMLESS A1 A4 A5 A6 A7 A16 A36 A37	A/COM B C D E F G	<ul style="list-style-type: none"> • 360 Degree Swivel • Pneumatic Seat Height Adjustment • Adjustable Back Depth • Rated for 250 lbs 	WIDTH: 26.5 DEPTH: 26.5 HEIGHT: 40.0-44.5 SEAT WIDTH: 22.0 SEAT DEPTH: 17.0 SEAT HEIGHT: 18.5-23.0 BACK WIDTH: 19.5 BACK HEIGHT: 23.0-26.0 COM: 0.9 YDS WEIGHT: 40.0 LB	A1 \$70 A4 \$75 A5 \$95 A6 \$130 A7 \$150 Black soft touch loop arm A4, 2-way adjustable arm for height A5, 4-way adjustable arm for height and width The A6 arm with Ura-Soft® arm pads, locking height adjustment, swivel pad, and adjustable arm pad position, A7 adds 4" arm width adjustment knob under seat.		
1660	S2	MID-BACK SWIVEL TILT CONTROL Use for a variety of general office seating, including private office and conference room seating.	ARMLESS A1 A4 A5 A6 A7 A16 A36 A37	A/COM B C D E F G	<ul style="list-style-type: none"> • Pneumatic Seat Height Adjustment • Tilt Tension Control • Seat and Back Tilt as a Unit • Upright Position Tilt Lock • Adjustable back depth • Rated for 250 lbs 	WIDTH: 26.5 DEPTH: 26.5 HEIGHT: 40.0-44.5 SEAT WIDTH: 22.0 SEAT DEPTH: 17.0 SEAT HEIGHT: 18.5-23.0 BACK WIDTH: 19.5 BACK HEIGHT: 23.0-26.0 COM: 0.9 YDS WEIGHT: 42.0 LB	A16 \$100 A36 \$105 A37 \$125 Black Soft Touch C-Shape Arm w/ Upholstered Pad 1/2 inch thick and 13" long 8-Way Adjustable Arms Soft-Touch sliding and pivoting arm pads. 10 -Way Adjustable Arms Soft-Touch sliding and pivoting arm pads and 4" arm width knob under seat.		
1660	P1	MID-BACK POSTURE BACK CONTROL The articulating back provides proper support for moderate tasking applications.	ARMLESS A1 A4 A5 A6 A7 A16 A36 A37	A/COM B C D E F G	<ul style="list-style-type: none"> • Pneumatic Seat Height Adjustment • Infinite back angle adjust with free float • Back Tilt Adjustment • Ratchet Back Height Lumbar Adjustment • Rated for 250 lbs 	WIDTH: 26.5 DEPTH: 26.5 HEIGHT: 40.0-47.5 SEAT WIDTH: 22.0 SEAT DEPTH: 17.0 SEAT HEIGHT: 18.5-23.0 BACK WIDTH: 19.5 BACK HEIGHT: 23.0-26.0 COM: 0.9 YDS WEIGHT: 44.0 LB	C1 STD C1S \$35 C2S \$35 50mm Hooded Casters 50mm Hooded Hard Floor Casters 50mm Hooded Self-Locking Hard Floor Casters		
1660	R1	MID-BACK ROCKING CONTROL For managerial and task applications. Similar to a swivel tilt control, with the added comfort of infinite back angle and tilt adjustment.	ARMLESS A1 A4 A5 A6 A7 A16 A36 A37	A/COM B C D E F G	<ul style="list-style-type: none"> • Pneumatic Seat Height Adjustment • Tilt Tension Control • Seat and Back Tilt as a Unit • Floating Seat Position Tilt Lock • Infinite Back Angle Adj w/ Free Float • Ratchet Back Height Lumbar Adjustment • Rated for 250 lbs 	WIDTH: 26.5 DEPTH: 26.5 HEIGHT: 40.0-47.5 SEAT WIDTH: 22.0 SEAT DEPTH: 16.0 SEAT HEIGHT: 18.5-23.0 BACK WIDTH: 19.5 BACK HEIGHT: 23.0-26.0 COM: 0.9 YDS WEIGHT: 46.0 LB	BT \$15 EF1 \$30 MF1 \$50 Replace Knob with Bolt (for B2 or S2 Controls ONLY) 1" extra foam on seat 1" Visco elastic memory foam on seat		

agent

lending comfort, durability and value to every project

GSA SIN # 711-18

- Task, stool, and conference seating
- Ratchet back height adjustment on P1
- Warranted up to 250 lbs with S2, R1, P1
- Warranted up to 300 lbs with M1, Y2
- CAL TB 133 Fire Code approved



CREATING AGENT MODEL NUMBER

MODEL NUMBER CONTROL ARMS GRADE CASTERS PACKAGING OPTIONS

1 6 6 0 - [] [] - A [] [] - [] [] [] - [] [] [] - [] [] []

* FOR ARMLESS CODE USE A00 * GT MODELS DO NOT HAVE A CASTER CODE

PACKAGING NOTES

CODE	DESCRIPTION	LIST UPCHARGE
AB	ASSEMBLED IN BAG FOR WILL CALL	\$0
PAC	PARTIALLY ASSEMBLED IN CARTON	\$0
BAC	BACK ASSEMBLED IN CARTON	\$40

MID-BACK

MODEL	CONTROL	DESCRIPTION	ARM	FABRIC	FEATURES	DIMENSIONS	ARM OPTIONS																																																																						
1660	M1	MID-BACK MULTI-FUNCTION CONTROL Fully articulating seat and back for the highest level of ergonomic needs. Forward seat pitch adjustment from 0 to 6 degrees.	<ul style="list-style-type: none"> ARMLESS A1 A4 A5 A6 A7 A16 A36 A37 	<table border="1"> <thead> <tr> <th>A/COM</th> <th>B</th> <th>C</th> <th>D</th> <th>E</th> <th>F</th> <th>G</th> </tr> </thead> <tbody> <tr><td>485</td><td>515</td><td>535</td><td>565</td><td>600</td><td>640</td><td>680</td></tr> <tr><td>555</td><td>585</td><td>605</td><td>635</td><td>670</td><td>710</td><td>750</td></tr> <tr><td>560</td><td>590</td><td>610</td><td>640</td><td>675</td><td>715</td><td>755</td></tr> <tr><td>580</td><td>610</td><td>630</td><td>660</td><td>695</td><td>735</td><td>775</td></tr> <tr><td>615</td><td>645</td><td>665</td><td>695</td><td>730</td><td>770</td><td>810</td></tr> <tr><td>635</td><td>665</td><td>685</td><td>715</td><td>750</td><td>790</td><td>830</td></tr> <tr><td>585</td><td>615</td><td>635</td><td>665</td><td>700</td><td>740</td><td>780</td></tr> <tr><td>590</td><td>620</td><td>640</td><td>670</td><td>705</td><td>745</td><td>785</td></tr> <tr><td>610</td><td>640</td><td>660</td><td>690</td><td>725</td><td>765</td><td>805</td></tr> </tbody> </table>	A/COM	B	C	D	E	F	G	485	515	535	565	600	640	680	555	585	605	635	670	710	750	560	590	610	640	675	715	755	580	610	630	660	695	735	775	615	645	665	695	730	770	810	635	665	685	715	750	790	830	585	615	635	665	700	740	780	590	620	640	670	705	745	785	610	640	660	690	725	765	805	<ul style="list-style-type: none"> • Pneumatic Seat Height Adjustment • Tilt Tension Control • Seat and Back Tilt as a Unit • Floating Seat Position Tilt Lock • Infinite Back Angle Adj w/ Free Float • Seat Pivots from 0° to 6° Forward • Ratchet Back Height Lumbar Adjustment • Rated for 300 lbs 	<p>WIDTH: 26.5 DEPTH: 26.5 HEIGHT: 38.5-44.0 SEAT WIDTH: 22.0 SEAT DEPTH: 17.5-20.5 SEAT HEIGHT: 18.5-23.0 BACK WIDTH: 19.5 BACK HEIGHT: 23.0-26.0 COM: 0.9 YDS WEIGHT: 52.0 LB</p>	<p>ARM OPTIONS</p> <ul style="list-style-type: none"> A1 \$70: Black soft touch loop arm A4 \$75: A4, 2-way adjustable arm for height A5 \$95: A5, 4-way adjustable arm for height and width A6 \$130: The A6 arm with Ura-Soft® arm pads, locking height adjustment, swivel pad, and adjustable arm pad position. A7 \$150: A7 adds 4" arm width adjustment knob under seat.
A/COM	B	C	D	E	F	G																																																																							
485	515	535	565	600	640	680																																																																							
555	585	605	635	670	710	750																																																																							
560	590	610	640	675	715	755																																																																							
580	610	630	660	695	735	775																																																																							
615	645	665	695	730	770	810																																																																							
635	665	685	715	750	790	830																																																																							
585	615	635	665	700	740	780																																																																							
590	620	640	670	705	745	785																																																																							
610	640	660	690	725	765	805																																																																							
1660	Y2-SS	MID-BACK SYNCHRO TILT CONTROL Use for a variety of general office seating, including private office and conference room seating.	<ul style="list-style-type: none"> ARMLESS A1 A4 A5 A6 A7 A16 A36 A37 	<table border="1"> <thead> <tr> <th>A/COM</th> <th>B</th> <th>C</th> <th>D</th> <th>E</th> <th>F</th> <th>G</th> </tr> </thead> <tbody> <tr><td>525</td><td>555</td><td>575</td><td>605</td><td>640</td><td>680</td><td>720</td></tr> <tr><td>595</td><td>625</td><td>645</td><td>675</td><td>710</td><td>750</td><td>790</td></tr> <tr><td>600</td><td>630</td><td>650</td><td>680</td><td>715</td><td>755</td><td>795</td></tr> <tr><td>620</td><td>650</td><td>670</td><td>700</td><td>735</td><td>775</td><td>815</td></tr> <tr><td>655</td><td>685</td><td>705</td><td>735</td><td>770</td><td>810</td><td>850</td></tr> <tr><td>675</td><td>705</td><td>725</td><td>755</td><td>790</td><td>830</td><td>870</td></tr> <tr><td>625</td><td>655</td><td>675</td><td>705</td><td>740</td><td>780</td><td>820</td></tr> <tr><td>630</td><td>660</td><td>680</td><td>710</td><td>745</td><td>785</td><td>825</td></tr> <tr><td>650</td><td>680</td><td>700</td><td>730</td><td>765</td><td>805</td><td>845</td></tr> </tbody> </table>	A/COM	B	C	D	E	F	G	525	555	575	605	640	680	720	595	625	645	675	710	750	790	600	630	650	680	715	755	795	620	650	670	700	735	775	815	655	685	705	735	770	810	850	675	705	725	755	790	830	870	625	655	675	705	740	780	820	630	660	680	710	745	785	825	650	680	700	730	765	805	845	<ul style="list-style-type: none"> • Pneumatic Seat Height Adjustment • Side Tilt Tension Control • Back and Seat Tilt in 2:1 ratio • 4 Locking Positions • Safety Tilt Release • Ratchet Back Height Lumbar Adjustment • SS Seat Slider standard • Rated for 300 lbs 	<p>WIDTH: 26.5 DEPTH: 26.5 HEIGHT: 38.5-44.0 SEAT WIDTH: 22.0 SEAT DEPTH: 17.5-20.5 SEAT HEIGHT: 18.5-23.0 BACK WIDTH: 19.5 BACK HEIGHT: 23.0-26.0 COM: 0.9 YDS WEIGHT: 52.0 LB</p>	<p>ARM OPTIONS</p> <ul style="list-style-type: none"> A16 \$100: Black Soft Touch C-Shape Arm w/ Upholstered Pad 1/2 inch thick and 13" long A36 \$105: 8-Way Adjustable Arms Soft-Touch sliding and pivoting arm pads. A37 \$125: 10-Way Adjustable Arms Soft-Touch sliding and pivoting arm pads and 4" arm width knob under seat.
A/COM	B	C	D	E	F	G																																																																							
525	555	575	605	640	680	720																																																																							
595	625	645	675	710	750	790																																																																							
600	630	650	680	715	755	795																																																																							
620	650	670	700	735	775	815																																																																							
655	685	705	735	770	810	850																																																																							
675	705	725	755	790	830	870																																																																							
625	655	675	705	740	780	820																																																																							
630	660	680	710	745	785	825																																																																							
650	680	700	730	765	805	845																																																																							
1660	GT	GUEST Well suited for guest seating.	<ul style="list-style-type: none"> ARMLESS A1 	<table border="1"> <thead> <tr> <th>A/COM</th> <th>B</th> <th>C</th> <th>D</th> <th>E</th> <th>F</th> <th>G</th> </tr> </thead> <tbody> <tr><td>320</td><td>350</td><td>370</td><td>400</td><td>435</td><td>475</td><td>515</td></tr> <tr><td>390</td><td>420</td><td>440</td><td>470</td><td>505</td><td>545</td><td>585</td></tr> </tbody> </table>	A/COM	B	C	D	E	F	G	320	350	370	400	435	475	515	390	420	440	470	505	545	585	<ul style="list-style-type: none"> • Cantilever Base Design • Rated for 250 lbs 	<p>WIDTH: 26.5 DEPTH: 26.5 HEIGHT: 40.0 SEAT WIDTH: 22.0 SEAT DEPTH: 17.0 SEAT HEIGHT: 17.0 BACK WIDTH: 19.5 BACK HEIGHT: 23.0 COM: 0.9 YDS WEIGHT: 42.0 LB</p>	<p>CASTER OPTIONS</p> <ul style="list-style-type: none"> C1 STD: 50mm Hooded Casters C1S \$35: 50mm Hooded Hard Floor Casters C2S \$35: 50mm Hooded Self-Locking Hard Floor Casters 																																																	
A/COM	B	C	D	E	F	G																																																																							
320	350	370	400	435	475	515																																																																							
390	420	440	470	505	545	585																																																																							
		ADDITIONAL OPTIONS					<p>BT \$15: Replace Knob with Bolt (for B2 or S2 Controls ONLY)</p> <p>EF1 \$30: 1" extra foam on seat</p> <p>MF1 \$50: 1" Visco elastic memory foam on seat</p>																																																																						

SEAT SLIDER (SS) - STANDARD WITH THIS CONFIGURATION

SHIPS PARTIALLY ASSEMBLED PAC OR AB

agent

lending comfort, durability and value to every project

GSA SIN # 711-18

- Task, stool, and conference seating
- Ratchet back height adjustment on P1
- Warranted up to 250 lbs
- CAL TB 133 Fire Code approved



CREATING AGENT MODEL NUMBER

MODEL NUMBER CONTROL ARMS GRADE CASTERS PACKAGING OPTIONS

1 6 - - A - - C - - - -

* FOR ARMLESS CODE USE A00

PACKAGING NOTES

CODE	DESCRIPTION	LIST UPCHARGE
AB	ASSEMBLED IN BAG FOR WILL CALL	\$0
PAC	PARTIALLY ASSEMBLED IN CARTON	\$0
BAC	BACK ASSEMBLED IN CARTON	\$40

MID-BACK STOOL

MODEL	CONTROL	DESCRIPTION	ARM	FABRIC	FEATURES	DIMENSIONS	ARM OPTIONS								
1666	B2	10" STOOL BASIC CONTROL Use for work surfaces up to 42 inches high.	ARMLESS	A/COM 465	B 495	C 515	D 545	E 580	F 620	G 660	• 360 degree swivel • Pneumatic Seat Height Adjustment • Adjustable Back Depth • Height Adjustable Footring • Rated for 250 lbs	WIDTH: 26.5 DEPTH: 26.5 HEIGHT: 47.5-57.5 SEAT WIDTH: 22.0 SEAT DEPTH: 17.0 SEAT HEIGHT: 26.5-36.5 BACK WIDTH: 19.5 BACK HEIGHT: 23.0 COM: 0.9 YDS WEIGHT: 46.0 LB	A1 \$70 Black soft touch loop arm	A4 \$75 A5 \$95 A4, 2-way adjustable arm for height A5, 4-way adjustable arm for height and width	A6 \$130 A7 \$150 The A6 arm with Ura-Soft® arm pads, locking height adjustment, swivel pad, and adjustable arm pad position, A7 adds 4" arm width adjustment knob under seat.
			A1	535	565	585	615	650	690	730					
			A4	540	570	590	620	655	695	735					
			A5	560	590	610	640	675	715	755					
			A6	595	625	645	675	710	750	790					
			A7	615	645	665	695	730	770	810					
			A16	565	595	615	645	680	720	760					
			A36	570	600	620	650	685	725	765					
			A37	590	620	640	670	705	745	785					
							SEAT SLIDER (SS) - NOT AVAILABLE								
1666	P1	10" STOOL POSTURE BACK CONTROL Use for work surfaces up to 42 inches high.	ARMLESS	A/COM 550	B 580	C 600	D 630	E 665	F 705	G 745	• Pneumatic Seat Height Adjustment • Infinite back angle adjust with free float • Ratchet Back Height Lumbar Adjustment • Height Adjustable Footring • Rated for 250 lbs	WIDTH: 26.5 DEPTH: 26.5 HEIGHT: 47.5-61.0 SEAT WIDTH: 22.0 SEAT DEPTH: 17.0 SEAT HEIGHT: 26.5-36.5 BACK WIDTH: 19.5 BACK HEIGHT: 23.0-26.0 COM: 0.9 YDS WEIGHT: 50.0 LB	A16 \$100 Black Soft Touch C-Shape Arm w/ Upholstered Pad 1/2 inch thick and 13" long	A36 \$105 8-Way Adjustable Arms Soft-Touch sliding and pivoting arm pads.	A37 \$125 10-Way Adjustable Arms Soft-Touch sliding and pivoting arm pads and 4" arm width knob under seat.
			A1	620	650	670	700	735	775	815					
			A4	625	655	675	705	740	780	820					
			A5	645	675	695	725	760	800	840					
			A6	680	710	730	760	795	835	875					
			A7	700	730	750	780	815	855	895					
			A16	650	680	700	730	765	805	845					
			A36	655	685	705	735	770	810	850					
			A37	675	705	725	755	790	830	870					
							SEAT SLIDER (SS) - NOT AVAILABLE								
1668	B2	8" STOOL BASIC CONTROL Use for work surfaces up to 36 inches high.	ARMLESS	A/COM 465	B 495	C 515	D 545	E 580	F 620	G 660	• 360 degree swivel • Pneumatic Seat Height Adjustment • Adjustable back depth • Height Adjustable Footring • Rated for 250 lbs	WIDTH: 26.5 DEPTH: 26.5 HEIGHT: 43.5-51.5 SEAT WIDTH: 22.0 SEAT DEPTH: 17.0 SEAT HEIGHT: 22.5-30.5 BACK WIDTH: 19.5 BACK HEIGHT: 23.0 COM: 0.9 YDS WEIGHT: 45.0 LB	C1 STD 50mm Hooded Casters	C1S \$35 50mm Hooded Hard Floor Casters	C2S \$35 50mm Hooded Self-Locking Hard Floor Casters
			A1	535	565	585	615	650	690	730					
			A4	540	570	590	620	655	695	735					
			A5	560	590	610	640	675	715	755					
			A6	595	625	645	675	710	750	790					
			A7	615	645	665	695	730	770	810					
			A16	565	595	615	645	680	720	760					
			A36	570	600	620	650	685	725	765					
			A37	590	620	640	670	705	745	785					
							SEAT SLIDER (SS) - NOT AVAILABLE								
1668	P1	8" STOOL POSTURE BACK CONTROL Use for work surfaces up to 36 inches high.	ARMLESS	A/COM 550	B 580	C 600	D 630	E 665	F 705	G 745	• Pneumatic Seat Height Adjustment • Infinite back angle adjust with free float • Ratchet Back Height Lumbar Adjustment • Height Adjustable Footring • Rated for 250 lbs	WIDTH: 26.5 DEPTH: 26.5 HEIGHT: 43.5-55.0 SEAT WIDTH: 22.0 SEAT DEPTH: 17.0 SEAT HEIGHT: 22.5-30.5 BACK WIDTH: 19.5 BACK HEIGHT: 23.0-26.0 COM: 0.9 YDS WEIGHT: 49.0 LB	BT \$15 Replace Knob with Bolt (for B2 or S2 Controls ONLY)	EF1 \$30 1" extra foam on seat	MF1 \$50 1" Visco elastic memory foam on seat
			A1	620	650	670	700	735	775	815					
			A4	625	655	675	705	740	780	820					
			A5	645	675	695	725	760	800	840					
			A6	680	710	730	760	795	835	875					
			A7	700	730	750	780	815	855	895					
			A16	650	680	700	730	765	805	845					
			A36	655	685	705	735	770	810	850					
			A37	675	705	725	755	790	830	870					
							SEAT SLIDER (SS) - NOT AVAILABLE								

aria

provides revolutionary comfort

MESH BACK

GSA SIN # 711-18

- Task, stool, management, and conference seating
- Suspension seat incorporates a flexible high performance mesh with a molded high density foam overlay
- Choice of 8 back mesh colors
- Integrated handle in chair back
- Optional height adjustable lumbar
- Warranted up to 250 lbs on Y1
- Warranted up to 300 lbs on Y3
- CAL TB 133 Fire Code approved



CREATING ARIA MODEL NUMBER

MODEL NUMBER CONTROL ARMS BACK MESH COLOR GRADE CASTERS PACKAGING OPTIONS

1 8 6 0 - [] - A [] - M 2 [] - [] - C 6 [] - [] - [] - []

* FOR ARMLESS CODE USE A00

PACKAGING NOTES

CODE	DESCRIPTION	LIST UPCHARGE
AB	ASSEMBLED IN BAG FOR WILL CALL	\$0
PAC	PARTIALLY ASSEMBLED IN CARTON	\$0
BAC	BACK ASSEMBLED IN CARTON	\$40

MODEL CONTROL DESCRIPTION

ARM FABRIC/LEATHER

FEATURES

DIMENSIONS

ARM OPTIONS

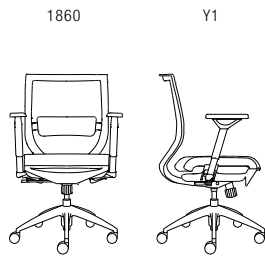

MID-BACK SIMPLE SYNCHRO TILT CONTROL

Use for a variety of general office seating, including private office and conference room seating.

ARM	A/COM	B	C	D	E	F	G	L3/COL	L4	L5
ARMLESS	490	520	540	570	605	645	685	550	620	650
A6	620	650	670	700	735	775	815	680	750	780
A8B / A8S	575	605	625	655	690	730	770	635	705	735
A10	575	605	625	655	690	730	770	635	705	735
A36	595	625	645	675	710	750	790	655	725	755
A40	600	630	650	680	715	755	795	660	730	760
A41	620	650	670	700	735	775	815	680	750	780

SEAT SLIDER (SS) - NOT AVAILABLE

- Pneumatic Seat Height Adjustment
- Tilt Tension Control
- Back and Seat Tilt in 3:1 Ratio
- Upright Position Tilt Lock
- Molded Foam Suspension Seat
- Optional Height Adjustable Lumbar
- Rated for 250 lbs

WIDTH: 25.0-26.5
 DEPTH: 27.5
 HEIGHT: 36.0-40.5
 SEAT WIDTH: 21.0
 SEAT DEPTH: 16.5
 SEAT HEIGHT: 18.0-22.5
 BACK WIDTH: 19.0
 BACK HEIGHT: 18.5
 COM: 0.9 YDS
 COL: 8.0 SQ FT
 WEIGHT: 36.0 LB

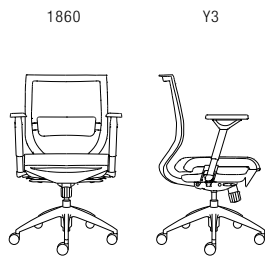
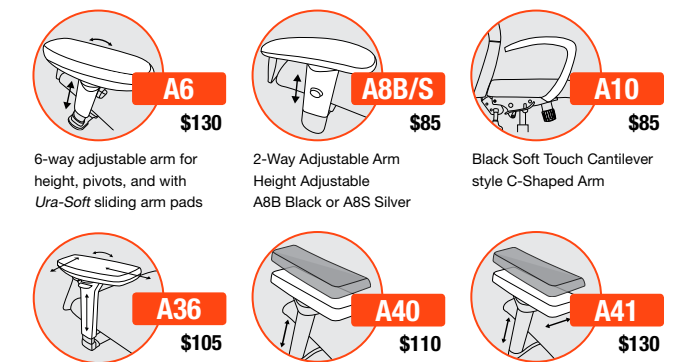

MID-BACK FULL SYNCHRO TILT CONTROL

Use for a variety of general office seating, including private office and conference room seating.

ARM	A/COM	B	C	D	E	F	G	L3/COL	L4	L5
ARMLESS	560	590	610	640	675	715	755	620	690	720
A6	690	720	740	770	805	845	885	750	820	850
A8B / A8S	645	675	695	725	760	800	840	705	775	805
A10	645	675	695	725	760	800	840	705	775	805
A36	665	695	715	745	780	820	860	725	795	825
A40	670	700	720	750	785	825	865	730	800	830
A41	690	720	740	770	805	845	885	750	820	850

SEAT SLIDER (SS) - NOT AVAILABLE

- Pneumatic Seat Height Adjustment
- Tilt Tension Control
- Back and Seat Tilt in 2:1 ratio
- 3 Locking Positions
- Safety Tilt Release
- Injection Molded Suspension Seat
- Optional Height Adjustable Lumbar
- Rated for 300 lbs

WIDTH: 25.0-26.5
 DEPTH: 27.5
 HEIGHT: 36.0-40.5
 SEAT WIDTH: 21.0
 SEAT DEPTH: 16.5
 SEAT HEIGHT: 18.0-22.5
 BACK WIDTH: 19.0
 BACK HEIGHT: 18.5
 COM: 0.9 YDS
 COL: 8.0 SQ FT
 WEIGHT: 38.0 LB

CASTER OPTIONS

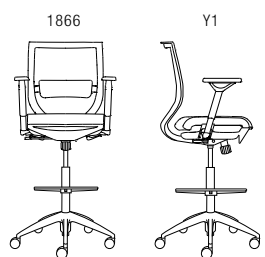
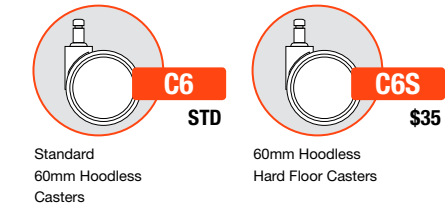

10" TRAVEL HIGH STOOL SIMPLE SYNCHRO TILT CONTROL

Use for work surfaces up to 42 inches high.

ARM	A/COM	B	C	D	E	F	G	L3/COL	L4	L5
ARMLESS	615	645	665	695	730	770	810	675	745	775
A6	745	775	795	825	860	900	940	805	875	905
A8B / A8S	700	730	750	780	815	855	895	760	830	860
A10	700	730	750	780	815	855	895	760	830	860
A36	720	750	770	790	835	875	915	780	850	880
A40	725	755	775	805	840	880	920	785	855	885
A41	745	775	795	825	860	900	940	805	875	905

SEAT SLIDER - NOT AVAILABLE

- Pneumatic Seat Height Adjustment
- Tilt Tension Control
- Back and Seat Tilt in 3:1 Ratio
- Upright Position Tilt Lock
- Molded Foam Suspension Seat
- Optional Height Adjustable Lumbar
- Height Adj 20" Diameter Foot

WIDTH: 25.0-26.5
 DEPTH: 27.5
 HEIGHT: 45.5-55.5
 SEAT WIDTH: 21.0
 SEAT DEPTH: 16.5
 SEAT HEIGHT: 27.5-37.5
 BACK WIDTH: 19.0
 BACK HEIGHT: 18.5
 COM: 0.9 YDS
 COL: 8.0 SQ FT
 WEIGHT: 44.0 LB

ADDITIONAL OPTIONS

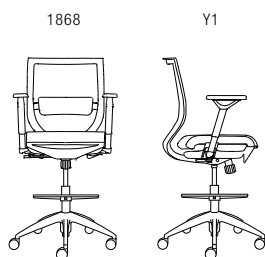
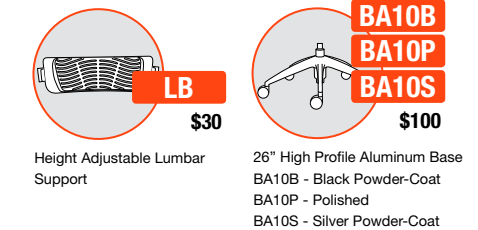

8" TRAVEL LOW STOOL SIMPLE SYNCHRO TILT CONTROL

Use for work surfaces up to 36 inches high.

ARM	A/COM	B	C	D	E	F	G	L3/COL	L4	L5
ARMLESS	615	645	665	695	730	770	810	675	745	775
A6	745	775	795	825	860	900	940	805	875	905
A8B / A8S	700	730	750	780	815	855	895	760	830	860
A10	700	730	750	780	815	855	895	760	830	860
A36	720	750	770	790	835	875	915	780	850	880
A40	725	755	775	805	840	880	920	785	855	885
A41	745	775	795	825	860	900	940	805	875	905

SEAT SLIDER - NOT AVAILABLE

- Pneumatic Seat Height Adjustment
- Tilt Tension Control
- Back and Seat Tilt in 3:1 Ratio
- Upright Position Tilt Lock
- Molded Foam Suspension Seat
- Optional Height Adjustable Lumbar
- Height Adj 20" Diameter Footring
- Rated for 250 lbs

WIDTH: 25.0-26.5
 DEPTH: 27.5
 HEIGHT: 40.5-48.5
 SEAT WIDTH: 21.0
 SEAT DEPTH: 16.5
 SEAT HEIGHT: 22.5-30.5
 BACK WIDTH: 19.0
 BACK HEIGHT: 18.5
 COM: 0.9 YDS
 COL: 8.0 SQ FT
 WEIGHT: 43.0 LB

MESH COLORS

BLACK M21	GRAY M22	WHITE M23	GREEN M24
RED M25	BLUE M26	ORANGE M27	AQUA M28

aria

provides revolutionary comfort

MESH BACK

GSA SIN # 711-18

- Task, stool, management, and conference seating
- Suspension seat incorporates a flexible high performance mesh with a molded high density foam overlay
- Choice of 8 back mesh colors
- Integrated handle in chair back
- Optional height adjustable lumbar
- Warranted up to 300 lbs
- CAL TB 133 Fire Code approved



CREATING ARIA MODEL NUMBER

MODEL NUMBER CONTROL ARMS BACK MESH COLOR GRADE CASTERS PACKAGING OPTIONS

1 8 8 0 - [] [] - A [] [] - M 2 [] [] - [] [] - C 6 [] [] - [] [] [] [] [] []

* FOR ARMLESS CODE USE A00

PACKAGING NOTES

CODE	DESCRIPTION	LIST UPCHARGE
AB	ASSEMBLED IN BAG FOR WILL CALL	\$0
PAC	PARTIALLY ASSEMBLED IN CARTON	\$0
BAC	BACK ASSEMBLED IN CARTON	\$40

MODEL	CONTROL	DESCRIPTION	ARM	FABRIC/LEATHER	FEATURES	DIMENSIONS																																																																																
1880	Y4	HIGH-BACK INTENSIVE SYNCHRO TILT CONTROL Use for a variety of general office task seating, including private office and conference room seating.	ARMLESS	<table border="1"> <thead> <tr> <th>A/COM</th> <th>B</th> <th>C</th> <th>D</th> <th>E</th> <th>F</th> <th>G</th> <th>L3/COL</th> <th>L4</th> <th>L5</th> </tr> </thead> <tbody> <tr> <td>615</td> <td>645</td> <td>665</td> <td>695</td> <td>730</td> <td>770</td> <td>810</td> <td>675</td> <td>745</td> <td>775</td> </tr> <tr> <td>A6</td> <td>745</td> <td>775</td> <td>795</td> <td>825</td> <td>860</td> <td>900</td> <td>805</td> <td>875</td> <td>905</td> </tr> <tr> <td>A8B / A8S</td> <td>700</td> <td>730</td> <td>750</td> <td>780</td> <td>815</td> <td>855</td> <td>895</td> <td>760</td> <td>830</td> </tr> <tr> <td>A10</td> <td>700</td> <td>730</td> <td>750</td> <td>780</td> <td>815</td> <td>855</td> <td>895</td> <td>760</td> <td>830</td> </tr> <tr> <td>A36</td> <td>720</td> <td>750</td> <td>770</td> <td>790</td> <td>835</td> <td>875</td> <td>915</td> <td>780</td> <td>850</td> </tr> <tr> <td>A40</td> <td>725</td> <td>755</td> <td>775</td> <td>805</td> <td>840</td> <td>880</td> <td>920</td> <td>785</td> <td>855</td> </tr> <tr> <td>A41</td> <td>745</td> <td>775</td> <td>795</td> <td>825</td> <td>860</td> <td>900</td> <td>940</td> <td>805</td> <td>875</td> </tr> </tbody> </table>	A/COM	B	C	D	E	F	G	L3/COL	L4	L5	615	645	665	695	730	770	810	675	745	775	A6	745	775	795	825	860	900	805	875	905	A8B / A8S	700	730	750	780	815	855	895	760	830	A10	700	730	750	780	815	855	895	760	830	A36	720	750	770	790	835	875	915	780	850	A40	725	755	775	805	840	880	920	785	855	A41	745	775	795	825	860	900	940	805	875	<ul style="list-style-type: none"> • Pneumatic Seat Height Adjustment • Side Tilt Tension Control • Back and Seat Tilt in 2:1 ratio • 4 Locking Positions • Safety Tilt Release • Forward Seat Pitch Adjustment • Standard Seat Slider • Injection Molded Suspension Seat • Optional Height Adjustable Lumbar • Rated for 300 lbs 	WIDTH: 25.0-26.5 DEPTH: 27.5 HEIGHT: 40.0-43.0 SEAT WIDTH: 21.0 SEAT DEPTH: 17.0-19.5 SEAT HEIGHT: 17.5-20.5 BACK WIDTH: 19.0 BACK HEIGHT: 23.0 COM: 0.9 YD COL: 8.0 SQ FT WEIGHT: 44.0 LB
A/COM	B		C	D	E	F	G	L3/COL	L4	L5																																																																												
615	645		665	695	730	770	810	675	745	775																																																																												
A6	745		775	795	825	860	900	805	875	905																																																																												
A8B / A8S	700		730	750	780	815	855	895	760	830																																																																												
A10	700		730	750	780	815	855	895	760	830																																																																												
A36	720	750	770	790	835	875	915	780	850																																																																													
A40	725	755	775	805	840	880	920	785	855																																																																													
A41	745	775	795	825	860	900	940	805	875																																																																													
			A6																																																																																			
			A8B / A8S																																																																																			
			A10																																																																																			
			A36																																																																																			
			A40																																																																																			
			A41																																																																																			
				SEAT SLIDER (SS) - STANDARD																																																																																		
1885	Y4	HIGH-BACK W/ HEADREST INTENSIVE SYNCHRO TILT CONTROL Use for a variety of general office task seating, including private office and conference room seating.	ARMLESS	<table border="1"> <thead> <tr> <th>A/COM</th> <th>B</th> <th>C</th> <th>D</th> <th>E</th> <th>F</th> <th>G</th> <th>L3/COL</th> <th>L4</th> <th>L5</th> </tr> </thead> <tbody> <tr> <td>700</td> <td>730</td> <td>750</td> <td>780</td> <td>815</td> <td>855</td> <td>895</td> <td>760</td> <td>830</td> <td>860</td> </tr> <tr> <td>A6</td> <td>830</td> <td>860</td> <td>880</td> <td>910</td> <td>945</td> <td>985</td> <td>1025</td> <td>890</td> <td>960</td> </tr> <tr> <td>A8B / A8S</td> <td>785</td> <td>815</td> <td>835</td> <td>865</td> <td>900</td> <td>940</td> <td>980</td> <td>845</td> <td>915</td> </tr> <tr> <td>A10</td> <td>785</td> <td>815</td> <td>835</td> <td>865</td> <td>900</td> <td>940</td> <td>980</td> <td>845</td> <td>915</td> </tr> <tr> <td>A36</td> <td>805</td> <td>835</td> <td>855</td> <td>885</td> <td>920</td> <td>960</td> <td>1000</td> <td>865</td> <td>935</td> </tr> <tr> <td>A40</td> <td>810</td> <td>840</td> <td>860</td> <td>890</td> <td>925</td> <td>965</td> <td>1005</td> <td>870</td> <td>940</td> </tr> <tr> <td>A41</td> <td>830</td> <td>860</td> <td>880</td> <td>910</td> <td>945</td> <td>985</td> <td>1025</td> <td>890</td> <td>960</td> </tr> </tbody> </table>	A/COM	B	C	D	E	F	G	L3/COL	L4	L5	700	730	750	780	815	855	895	760	830	860	A6	830	860	880	910	945	985	1025	890	960	A8B / A8S	785	815	835	865	900	940	980	845	915	A10	785	815	835	865	900	940	980	845	915	A36	805	835	855	885	920	960	1000	865	935	A40	810	840	860	890	925	965	1005	870	940	A41	830	860	880	910	945	985	1025	890	960	<ul style="list-style-type: none"> • Pneumatic Seat Height Adjustment • Side Tilt Tension Control • Back and Seat Tilt in 2:1 ratio • 4 Locking Positions • Safety Tilt Release • Forward Seat Pitch Adjustment • Standard Seat Slider • Injection Molded Suspension Seat • Optional Height Adjustable Lumbar • Rated for 300 lbs 	WIDTH: 25.0-26.5 DEPTH: 27.5 HEIGHT: 36.0-40.5 SEAT WIDTH: 21.0 SEAT DEPTH: 16.5 SEAT HEIGHT: 18.0-22.5 BACK WIDTH: 19.0 BACK HEIGHT: 18.5 COM: 0.9 YD COL: 8.0 SQ FT WEIGHT: 38.0 LB
A/COM	B		C	D	E	F	G	L3/COL	L4	L5																																																																												
700	730		750	780	815	855	895	760	830	860																																																																												
A6	830		860	880	910	945	985	1025	890	960																																																																												
A8B / A8S	785		815	835	865	900	940	980	845	915																																																																												
A10	785		815	835	865	900	940	980	845	915																																																																												
A36	805	835	855	885	920	960	1000	865	935																																																																													
A40	810	840	860	890	925	965	1005	870	940																																																																													
A41	830	860	880	910	945	985	1025	890	960																																																																													
			A6																																																																																			
			A8B / A8S																																																																																			
			A10																																																																																			
			A36																																																																																			
			A40																																																																																			
			A41																																																																																			
				SEAT SLIDER (SS) - STANDARD																																																																																		
1860	GT	GUEST Black four leg steel frame side chair.	SWA	<table border="1"> <thead> <tr> <th>A/COM</th> <th>B</th> <th>C</th> <th>D</th> <th>E</th> <th>F</th> <th>G</th> <th>L3/COL</th> <th>L4</th> <th>L5</th> </tr> </thead> <tbody> <tr> <td>450</td> <td>480</td> <td>500</td> <td>530</td> <td>565</td> <td>605</td> <td>645</td> <td>530</td> <td>580</td> <td>660</td> </tr> </tbody> </table>	A/COM	B	C	D	E	F	G	L3/COL	L4	L5	450	480	500	530	565	605	645	530	580	660	<ul style="list-style-type: none"> • Black Four Leg Style Frame • Rated for 300 lbs 	WIDTH: 25.0-26.5 DEPTH: 27.5 HEIGHT: 45.5-55.5 SEAT WIDTH: 21.0 SEAT DEPTH: 16.5 SEAT HEIGHT: 27.5-37.5 BACK WIDTH: 19.0 BACK HEIGHT: 18.5 COM: 0.9 YD COL: 8.0 SQ FT WEIGHT: 44.0 LB																																																												
A/COM	B		C	D	E	F	G	L3/COL	L4	L5																																																																												
450	480		500	530	565	605	645	530	580	660																																																																												
				SHIPS PARTIALLY ASSEMBLED PAC OR AB / SWA - STANDARD WITH ARMS																																																																																		

ARM OPTIONS

<p>A6 \$130</p>	<p>A8B/S \$85</p>	<p>A10 \$85</p>
<p>A36 \$105</p>	<p>A40 \$110</p>	<p>A41 \$130</p>

CASTER OPTIONS

<p>C6 STD</p>	<p>C6S \$35</p>
----------------------	----------------------------

ADDITIONAL OPTIONS

<p>LB \$30</p>	<p>BA10B BA10P BA10S \$100</p>	<p>HD \$125</p>
---------------------------	---	----------------------------

MESH COLORS

BLACK M21	GRAY M22	WHITE M23	GREEN M24
RED M25	BLUE M26	ORANGE M27	AQUA M28

axis

great design never goes out of style

GSA SIN # 711-18

- Conference and executive seating
- Warranted up to 250 lbs, S1
- Warranted up to 300 lbs, K1



CREATING AXIS MODEL NUMBER

MODEL NUMBER CONTROL ARMS GRADE CASTERS PACKAGING OPTIONS

2 6 0 0 - [] [] - A [] [] - [] [] - [] [] [] - [] [] [] [] [] []

* FOR ARMLESS CODE USE A00 * GT MODELS DO NOT HAVE A CASTER CODE

PACKAGING NOTES

CODE	DESCRIPTION	LIST UPCHARGE
AB	ASSEMBLED IN BAG FOR WILL CALL	\$0
BAC	BACK ASSEMBLED IN CARTON	\$0

MID-BACK

MODEL	CONTROL	DESCRIPTION	ARM	FABRIC/LEATHER	FEATURES	DIMENSIONS	ARM OPTIONS																																																																																						
2600	S1	MID-BACK SWIVEL TILT CONTROL Use for a variety of general office seating, including private office and conference room seating.	ARMLESS	<table border="1"> <thead> <tr> <th>A/COM</th> <th>B</th> <th>C</th> <th>D</th> <th>E</th> <th>F</th> <th>G</th> <th>L3/COL</th> <th>L4</th> <th>L5</th> </tr> </thead> <tbody> <tr><td>500</td><td>580</td><td>630</td><td>710</td><td>800</td><td>900</td><td>1015</td><td>550</td><td>650</td><td>1240</td></tr> <tr><td>A4</td><td>575</td><td>655</td><td>705</td><td>785</td><td>875</td><td>975</td><td>1090</td><td>625</td><td>725</td><td>1315</td></tr> <tr><td>A8B</td><td>585</td><td>665</td><td>715</td><td>795</td><td>885</td><td>985</td><td>1100</td><td>635</td><td>735</td><td>1325</td></tr> <tr><td>A8S</td><td>585</td><td>665</td><td>715</td><td>795</td><td>885</td><td>985</td><td>1100</td><td>635</td><td>735</td><td>1325</td></tr> <tr><td>A16</td><td>600</td><td>680</td><td>730</td><td>810</td><td>900</td><td>1000</td><td>1115</td><td>650</td><td>750</td><td>1340</td></tr> <tr><td>A16P</td><td>650</td><td>730</td><td>780</td><td>860</td><td>950</td><td>1050</td><td>1165</td><td>700</td><td>800</td><td>1390</td></tr> <tr><td>A36</td><td>605</td><td>685</td><td>735</td><td>815</td><td>905</td><td>1005</td><td>1120</td><td>655</td><td>755</td><td>1345</td></tr> </tbody> </table>	A/COM	B	C	D	E	F	G	L3/COL	L4	L5	500	580	630	710	800	900	1015	550	650	1240	A4	575	655	705	785	875	975	1090	625	725	1315	A8B	585	665	715	795	885	985	1100	635	735	1325	A8S	585	665	715	795	885	985	1100	635	735	1325	A16	600	680	730	810	900	1000	1115	650	750	1340	A16P	650	730	780	860	950	1050	1165	700	800	1390	A36	605	685	735	815	905	1005	1120	655	755	1345	<ul style="list-style-type: none"> • Pneumatic Seat Height Adjustment • Tilt Tension Control • Seat and Back Tilt as a Unit • Upright Position Tilt Lock • Rated for 250 lbs 	WIDTH: 24.0 DEPTH: 29.5 HEIGHT: 39.0-43.5 SEAT WIDTH: 20.0 SEAT DEPTH: 19.5 BACK WIDTH: 23.0 BACK HEIGHT: 20.0 COM: 2.9 YD COL: 37.0 SQ FT WEIGHT: 54.5 LB	
A/COM	B		C	D	E	F	G	L3/COL	L4	L5																																																																																			
500	580		630	710	800	900	1015	550	650	1240																																																																																			
A4	575		655	705	785	875	975	1090	625	725	1315																																																																																		
A8B	585		665	715	795	885	985	1100	635	735	1325																																																																																		
A8S	585	665	715	795	885	985	1100	635	735	1325																																																																																			
A16	600	680	730	810	900	1000	1115	650	750	1340																																																																																			
A16P	650	730	780	860	950	1050	1165	700	800	1390																																																																																			
A36	605	685	735	815	905	1005	1120	655	755	1345																																																																																			
2600	K1	MID-BACK KNEE TILT CONTROL Ultimate seating comfort suited for the executive or manager. Allows for a full range of movement with a sharp, simple look.	ARMLESS	<table border="1"> <thead> <tr> <th>A/COM</th> <th>B</th> <th>C</th> <th>D</th> <th>E</th> <th>F</th> <th>G</th> <th>L3/COL</th> <th>L4</th> <th>L5</th> </tr> </thead> <tbody> <tr><td>550</td><td>630</td><td>680</td><td>760</td><td>850</td><td>950</td><td>1065</td><td>600</td><td>700</td><td>1290</td></tr> <tr><td>A4</td><td>625</td><td>705</td><td>755</td><td>835</td><td>925</td><td>1025</td><td>1140</td><td>675</td><td>775</td><td>1365</td></tr> <tr><td>A8B</td><td>635</td><td>715</td><td>765</td><td>845</td><td>935</td><td>1035</td><td>1150</td><td>685</td><td>785</td><td>1375</td></tr> <tr><td>A8S</td><td>635</td><td>715</td><td>765</td><td>845</td><td>935</td><td>1035</td><td>1150</td><td>685</td><td>785</td><td>1375</td></tr> <tr><td>A16</td><td>650</td><td>730</td><td>780</td><td>860</td><td>950</td><td>1050</td><td>1165</td><td>700</td><td>800</td><td>1390</td></tr> <tr><td>A16P</td><td>700</td><td>780</td><td>830</td><td>910</td><td>1000</td><td>1100</td><td>1215</td><td>750</td><td>850</td><td>1440</td></tr> <tr><td>A36</td><td>655</td><td>735</td><td>785</td><td>865</td><td>955</td><td>1055</td><td>1170</td><td>705</td><td>805</td><td>1395</td></tr> </tbody> </table>	A/COM	B	C	D	E	F	G	L3/COL	L4	L5	550	630	680	760	850	950	1065	600	700	1290	A4	625	705	755	835	925	1025	1140	675	775	1365	A8B	635	715	765	845	935	1035	1150	685	785	1375	A8S	635	715	765	845	935	1035	1150	685	785	1375	A16	650	730	780	860	950	1050	1165	700	800	1390	A16P	700	780	830	910	1000	1100	1215	750	850	1440	A36	655	735	785	865	955	1055	1170	705	805	1395	<ul style="list-style-type: none"> • Pneumatic Seat Height Adjustment • Tilt Tension Control • Seat and Back Tilt as a Unit • 5 Locking Positions • Safety Tilt Release • Reduced Rise of Front of Seat • Rated for 300 lbs 	WIDTH: 24.0 DEPTH: 29.5 HEIGHT: 39.5-42.5 SEAT WIDTH: 20.0 SEAT DEPTH: 19.5 BACK WIDTH: 23.0 BACK HEIGHT: 20.0 COM: 2.9 YD COL: 37.0 SQ FT WEIGHT: 59.5 LB	
A/COM	B		C	D	E	F	G	L3/COL	L4	L5																																																																																			
550	630		680	760	850	950	1065	600	700	1290																																																																																			
A4	625		705	755	835	925	1025	1140	675	775	1365																																																																																		
A8B	635		715	765	845	935	1035	1150	685	785	1375																																																																																		
A8S	635	715	765	845	935	1035	1150	685	785	1375																																																																																			
A16	650	730	780	860	950	1050	1165	700	800	1390																																																																																			
A16P	700	780	830	910	1000	1100	1215	750	850	1440																																																																																			
A36	655	735	785	865	955	1055	1170	705	805	1395																																																																																			
2600	GT	GUEST Well suited for guest seating. Comes standard with non-marring glides.	ARMLESS	<table border="1"> <thead> <tr> <th>A/COM</th> <th>B</th> <th>C</th> <th>D</th> <th>E</th> <th>F</th> <th>G</th> <th>L3/COL</th> <th>L4</th> <th>L5</th> </tr> </thead> <tbody> <tr><td>480</td><td>560</td><td>610</td><td>690</td><td>780</td><td>880</td><td>995</td><td>530</td><td>630</td><td>1220</td></tr> <tr><td>A16</td><td>580</td><td>660</td><td>710</td><td>790</td><td>880</td><td>980</td><td>1095</td><td>630</td><td>730</td><td>1320</td></tr> <tr><td>A16P</td><td>630</td><td>710</td><td>760</td><td>840</td><td>930</td><td>1030</td><td>1145</td><td>680</td><td>780</td><td>1370</td></tr> </tbody> </table>	A/COM	B	C	D	E	F	G	L3/COL	L4	L5	480	560	610	690	780	880	995	530	630	1220	A16	580	660	710	790	880	980	1095	630	730	1320	A16P	630	710	760	840	930	1030	1145	680	780	1370	<ul style="list-style-type: none"> • Cantilever Frame Design • Non-Marring Floor Glides • Rated for 250 lbs 	WIDTH: 26.0 DEPTH: 29.5 HEIGHT: 40.0 SEAT WIDTH: 20.0 SEAT DEPTH: 19.5 BACK WIDTH: 23.0 BACK HEIGHT: 20.0 COM: 2.9 YD COL: 37.0 SQ FT WEIGHT: 50.0 LB																																													
A/COM	B		C	D	E	F	G	L3/COL	L4	L5																																																																																			
480	560		610	690	780	880	995	530	630	1220																																																																																			
A16	580	660	710	790	880	980	1095	630	730	1320																																																																																			
A16P	630	710	760	840	930	1030	1145	680	780	1370																																																																																			

SHIPS PARTIALLY ASSEMBLED BAC OR AB

axis

great design never goes out of style

GSA SIN # 711-18

- Conference and executive seating
- Warranted up to 250 lbs, S1
- Warranted up to 300 lbs, K1



CREATING AXIS MODEL NUMBER

MODEL NUMBER CONTROL ARMS GRADE CASTERS PACKAGING OPTIONS

2 6 1 0 - [] [] - A [] [] - [] [] - [] [] [] - [] [] [] [] [] []

* FOR ARMLESS CODE USE A00 * GT MODELS DO NOT HAVE A CASTER CODE

PACKAGING NOTES

CODE	DESCRIPTION	LIST UPCHARGE
AB	ASSEMBLED IN BAG FOR WILL CALL	\$0
BAC	BACK ASSEMBLED IN CARTON	\$0

HIGH-BACK

MODEL	CONTROL	DESCRIPTION	ARM	FABRIC/LEATHER	FEATURES	DIMENSIONS	ARM OPTIONS																																																																																
2610	S1	HIGH-BACK SWIVEL TILT CONTROL Use for a variety of general office seating, including private office and conference room seating.	ARMLESS	<table border="1"> <thead> <tr> <th>A/COM</th> <th>B</th> <th>C</th> <th>D</th> <th>E</th> <th>F</th> <th>G</th> <th>L3/COL</th> <th>L4</th> <th>L5</th> </tr> </thead> <tbody> <tr> <td>550</td> <td>640</td> <td>695</td> <td>785</td> <td>885</td> <td>1000</td> <td>1125</td> <td>600</td> <td>725</td> <td>1650</td> </tr> <tr> <td>625</td> <td>715</td> <td>770</td> <td>860</td> <td>960</td> <td>1075</td> <td>1200</td> <td>675</td> <td>800</td> <td>1725</td> </tr> <tr> <td>635</td> <td>725</td> <td>780</td> <td>870</td> <td>970</td> <td>1085</td> <td>1210</td> <td>685</td> <td>810</td> <td>1735</td> </tr> <tr> <td>635</td> <td>725</td> <td>780</td> <td>870</td> <td>970</td> <td>1085</td> <td>1210</td> <td>685</td> <td>810</td> <td>1735</td> </tr> <tr> <td>650</td> <td>740</td> <td>795</td> <td>885</td> <td>985</td> <td>1100</td> <td>1225</td> <td>700</td> <td>825</td> <td>1750</td> </tr> <tr> <td>700</td> <td>790</td> <td>845</td> <td>935</td> <td>1035</td> <td>1150</td> <td>1275</td> <td>750</td> <td>875</td> <td>1800</td> </tr> <tr> <td>655</td> <td>745</td> <td>800</td> <td>890</td> <td>990</td> <td>1105</td> <td>1230</td> <td>705</td> <td>830</td> <td>1755</td> </tr> </tbody> </table>	A/COM	B	C	D	E	F	G	L3/COL	L4	L5	550	640	695	785	885	1000	1125	600	725	1650	625	715	770	860	960	1075	1200	675	800	1725	635	725	780	870	970	1085	1210	685	810	1735	635	725	780	870	970	1085	1210	685	810	1735	650	740	795	885	985	1100	1225	700	825	1750	700	790	845	935	1035	1150	1275	750	875	1800	655	745	800	890	990	1105	1230	705	830	1755	<ul style="list-style-type: none"> • Pneumatic Seat Height Adjustment • Tilt Tension Control • Seat and Back Tilt as a Unit • Upright Position Tilt Lock • Rated for 250 lbs 	WIDTH: 24.0 DEPTH: 29.5 HEIGHT: 43.0-47.5 SEAT WIDTH: 20.0 SEAT DEPTH: 19.5 SEAT HEIGHT: 17.0-21.5 BACK WIDTH: 23.0 BACK HEIGHT: 24.0 COM: 3.2 YD COL: 54.0 SQ FT WEIGHT: 56.0 LB	
A/COM	B		C	D	E	F	G	L3/COL	L4	L5																																																																													
550	640	695	785	885	1000	1125	600	725	1650																																																																														
625	715	770	860	960	1075	1200	675	800	1725																																																																														
635	725	780	870	970	1085	1210	685	810	1735																																																																														
635	725	780	870	970	1085	1210	685	810	1735																																																																														
650	740	795	885	985	1100	1225	700	825	1750																																																																														
700	790	845	935	1035	1150	1275	750	875	1800																																																																														
655	745	800	890	990	1105	1230	705	830	1755																																																																														
2610	K1	HIGH-BACK KNEE TILT CONTROL Ultimate seating comfort suited for the executive or manager. Allows for a full range of movement with a sharp, simple look.	ARMLESS	<table border="1"> <thead> <tr> <th>A/COM</th> <th>B</th> <th>C</th> <th>D</th> <th>E</th> <th>F</th> <th>G</th> <th>L3/COL</th> <th>L4</th> <th>L5</th> </tr> </thead> <tbody> <tr> <td>600</td> <td>690</td> <td>745</td> <td>835</td> <td>935</td> <td>1050</td> <td>1175</td> <td>650</td> <td>775</td> <td>1700</td> </tr> <tr> <td>675</td> <td>765</td> <td>820</td> <td>910</td> <td>1010</td> <td>1125</td> <td>1250</td> <td>725</td> <td>850</td> <td>1775</td> </tr> <tr> <td>685</td> <td>775</td> <td>830</td> <td>920</td> <td>1020</td> <td>1135</td> <td>1260</td> <td>735</td> <td>850</td> <td>1785</td> </tr> <tr> <td>685</td> <td>775</td> <td>830</td> <td>920</td> <td>1020</td> <td>1135</td> <td>1260</td> <td>735</td> <td>860</td> <td>1785</td> </tr> <tr> <td>700</td> <td>790</td> <td>845</td> <td>935</td> <td>1035</td> <td>1150</td> <td>1275</td> <td>750</td> <td>875</td> <td>1800</td> </tr> <tr> <td>750</td> <td>840</td> <td>895</td> <td>985</td> <td>1085</td> <td>1200</td> <td>1325</td> <td>800</td> <td>925</td> <td>1850</td> </tr> <tr> <td>705</td> <td>795</td> <td>850</td> <td>940</td> <td>1040</td> <td>1155</td> <td>1280</td> <td>755</td> <td>880</td> <td>1805</td> </tr> </tbody> </table>	A/COM	B	C	D	E	F	G	L3/COL	L4	L5	600	690	745	835	935	1050	1175	650	775	1700	675	765	820	910	1010	1125	1250	725	850	1775	685	775	830	920	1020	1135	1260	735	850	1785	685	775	830	920	1020	1135	1260	735	860	1785	700	790	845	935	1035	1150	1275	750	875	1800	750	840	895	985	1085	1200	1325	800	925	1850	705	795	850	940	1040	1155	1280	755	880	1805	<ul style="list-style-type: none"> • Pneumatic Seat Height Adjustment • Tilt Tension Control • Seat and Back Tilt as a Unit • 5 Locking Positions • Safety Tilt Release • Reduced Rise of Front of Seat • Rated for 300 lbs 	WIDTH: 24.0 DEPTH: 29.5 HEIGHT: 42.5-45.5 SEAT WIDTH: 20.0 SEAT DEPTH: 19.5 SEAT HEIGHT: 17.5-20.5 BACK WIDTH: 23.0 BACK HEIGHT: 24.0 COM: 3.2 YD COL: 54.0 SQ FT WEIGHT: 61.0 LB	
A/COM	B		C	D	E	F	G	L3/COL	L4	L5																																																																													
600	690	745	835	935	1050	1175	650	775	1700																																																																														
675	765	820	910	1010	1125	1250	725	850	1775																																																																														
685	775	830	920	1020	1135	1260	735	850	1785																																																																														
685	775	830	920	1020	1135	1260	735	860	1785																																																																														
700	790	845	935	1035	1150	1275	750	875	1800																																																																														
750	840	895	985	1085	1200	1325	800	925	1850																																																																														
705	795	850	940	1040	1155	1280	755	880	1805																																																																														
												CASTER OPTIONS 																																																																											
												ADDITIONAL OPTIONS 																																																																											

bella

name your game, bella is ready to play

ALL PLASTIC - AP

GSA SIN # 711-19

- Back styles include: all plastic, upholstered, or mesh back
- Choice of plastic or upholstered seat
- Right hand tablet arm available with optional basket
- 6 powder coated frame finishes
- Warranted up to 250 lbs
- CAL TB 133 Fire Code approved



CREATING BELLA MODEL NUMBER

MODEL NUMBER CONTROL ARMS FRAME COLOR UPHOLSTERY MESH COLOR GRADE CASTERS PACKAGING OPTIONS

1 3 - G T - - - A P - M - P - C 5 - - -

* FOR ARMLESS CODE USE A00 * ONLY SELECT FOR MODELS 1360/1365 * ONLY SELECT CASTER CODE FOR MODELS 1315/1365

FRAME COLORS

BLACK BF	SILVER SF	METALLIC BROWN* MBF
GUNMETAL* GMF	DOVER GRAY* DGF	WHITE* WF

PACKAGING NOTES

CODE	DESCRIPTION	LIST UPCHARGE
AB	ASSEMBLED IN BAG FOR WILL CALL	\$0
AC	ASSEMBLED IN CARTON	\$0

BELLA STACK CHAIRS SHIP UP TO 3 PER CARTON

MODEL	CONTROL	DESCRIPTION	ARM	PLASTIC	FEATURES	DIMENSIONS	ARM OPTIONS	CASTER OPTIONS																											
1310	GT	GUEST STACKING Plastic back with plastic seat.	ARMLESS A12 A14 TAB-A00 TAB-A12 TAB-A14	P 210 255 290 330 355 370	<ul style="list-style-type: none"> • Non-Marring Floor Glides • Stack 4 High on Floor • Stacks 10 High on Optional Dolly • Wall Saver Back Legs • Integrated Handle in Back of Chair • Rated for 250 lbs 	<table border="1"> <thead> <tr> <th>ARMLESS</th> <th>W/ ARMS</th> </tr> </thead> <tbody> <tr><td>WIDTH:</td><td>21.0 25.0</td></tr> <tr><td>DEPTH:</td><td>26.0 26.0</td></tr> <tr><td>HEIGHT:</td><td>34.0 34.0</td></tr> <tr><td>SEAT WIDTH:</td><td>18.0 18.0</td></tr> <tr><td>SEAT DEPTH:</td><td>16.0 16.0</td></tr> <tr><td>SEAT HEIGHT:</td><td>18.5 18.5</td></tr> <tr><td>BACK WIDTH:</td><td>19.0 19.0</td></tr> <tr><td>BACK HEIGHT:</td><td>17.5 17.5</td></tr> <tr><td>COM:</td><td>N/A N/A</td></tr> <tr><td>WEIGHT:</td><td>13.0 LB 15.0 LB</td></tr> </tbody> </table>	ARMLESS	W/ ARMS	WIDTH:	21.0 25.0	DEPTH:	26.0 26.0	HEIGHT:	34.0 34.0	SEAT WIDTH:	18.0 18.0	SEAT DEPTH:	16.0 16.0	SEAT HEIGHT:	18.5 18.5	BACK WIDTH:	19.0 19.0	BACK HEIGHT:	17.5 17.5	COM:	N/A N/A	WEIGHT:	13.0 LB 15.0 LB	<table border="1"> <tbody> <tr> <td>A12 Fixed Arm \$45</td> <td>A14 Reinforced Soft Touch Extended Arm \$80</td> <td>C5 Standard 50mm Hooded Casters STD</td> </tr> <tr> <td>TAB-A00 Right Folding Tablet Arm in Black Only. Available for either frame finish BF/SF. *Not Stackable with Tablet \$120</td> <td>TAB-A14 Right Folding Tablet Arm w/ A14 Left Arm. Available for either frame finish BF/SF. *Not Stackable with Tablet \$160</td> <td>C5S 50mm Hooded Hard Floor Casters \$30</td> </tr> </tbody> </table>	A12 Fixed Arm \$45	A14 Reinforced Soft Touch Extended Arm \$80	C5 Standard 50mm Hooded Casters STD	TAB-A00 Right Folding Tablet Arm in Black Only. Available for either frame finish BF/SF. *Not Stackable with Tablet \$120	TAB-A14 Right Folding Tablet Arm w/ A14 Left Arm. Available for either frame finish BF/SF. *Not Stackable with Tablet \$160	C5S 50mm Hooded Hard Floor Casters \$30
ARMLESS	W/ ARMS																																		
WIDTH:	21.0 25.0																																		
DEPTH:	26.0 26.0																																		
HEIGHT:	34.0 34.0																																		
SEAT WIDTH:	18.0 18.0																																		
SEAT DEPTH:	16.0 16.0																																		
SEAT HEIGHT:	18.5 18.5																																		
BACK WIDTH:	19.0 19.0																																		
BACK HEIGHT:	17.5 17.5																																		
COM:	N/A N/A																																		
WEIGHT:	13.0 LB 15.0 LB																																		
A12 Fixed Arm \$45	A14 Reinforced Soft Touch Extended Arm \$80	C5 Standard 50mm Hooded Casters STD																																	
TAB-A00 Right Folding Tablet Arm in Black Only. Available for either frame finish BF/SF. *Not Stackable with Tablet \$120	TAB-A14 Right Folding Tablet Arm w/ A14 Left Arm. Available for either frame finish BF/SF. *Not Stackable with Tablet \$160	C5S 50mm Hooded Hard Floor Casters \$30																																	
1315	GT	GUEST STACKING WITH CASTERS Plastic back with plastic seat.	ARMLESS A12 A14 TAB-A00 TAB-A12 TAB-A14	P 255 300 335 375 400 415	<ul style="list-style-type: none"> • 50mm Hooded Casters • Stack 4 High on Floor • Stacks 10 High on Optional Dolly • Integrated Handle in Back of Chair • Rated for 250 lbs 	<table border="1"> <tbody> <tr><td>WIDTH:</td><td>21.0 25.0</td></tr> <tr><td>DEPTH:</td><td>26.0 26.0</td></tr> <tr><td>HEIGHT:</td><td>34.0 34.0</td></tr> <tr><td>SEAT WIDTH:</td><td>18.0 18.0</td></tr> <tr><td>SEAT DEPTH:</td><td>16.0 16.0</td></tr> <tr><td>SEAT HEIGHT:</td><td>18.5 18.5</td></tr> <tr><td>BACK WIDTH:</td><td>19.0 19.0</td></tr> <tr><td>BACK HEIGHT:</td><td>17.5 17.5</td></tr> <tr><td>COM:</td><td>N/A N/A</td></tr> <tr><td>WEIGHT:</td><td>13.0 LB 15.0 LB</td></tr> </tbody> </table>	WIDTH:	21.0 25.0	DEPTH:	26.0 26.0	HEIGHT:	34.0 34.0	SEAT WIDTH:	18.0 18.0	SEAT DEPTH:	16.0 16.0	SEAT HEIGHT:	18.5 18.5	BACK WIDTH:	19.0 19.0	BACK HEIGHT:	17.5 17.5	COM:	N/A N/A	WEIGHT:	13.0 LB 15.0 LB	<table border="1"> <tbody> <tr> <td>BSK Side Hanging Wire Basket for model 1310, 1315, 1360, 1365. Attach to left or right side. \$60</td> <td>DL1 Stacking Dolly Stack Chair 10 High \$250</td> </tr> </tbody> </table>	BSK Side Hanging Wire Basket for model 1310, 1315, 1360, 1365. Attach to left or right side. \$60	DL1 Stacking Dolly Stack Chair 10 High \$250						
WIDTH:	21.0 25.0																																		
DEPTH:	26.0 26.0																																		
HEIGHT:	34.0 34.0																																		
SEAT WIDTH:	18.0 18.0																																		
SEAT DEPTH:	16.0 16.0																																		
SEAT HEIGHT:	18.5 18.5																																		
BACK WIDTH:	19.0 19.0																																		
BACK HEIGHT:	17.5 17.5																																		
COM:	N/A N/A																																		
WEIGHT:	13.0 LB 15.0 LB																																		
BSK Side Hanging Wire Basket for model 1310, 1315, 1360, 1365. Attach to left or right side. \$60	DL1 Stacking Dolly Stack Chair 10 High \$250																																		
1360	GT	GUEST STACKING Mesh back with plastic seat.	ARMLESS A12 A14 TAB-A00 TAB-A12 TAB-A14	P 275 320 355 395 420 435	<ul style="list-style-type: none"> • Non-Marring Floor Glides • Stack 4 High on Floor • Stacks 10 High on Optional Dolly • Wall Saver Back Legs • Choice of 6 Mesh Back Colors • Rated for 250 lbs 	<table border="1"> <tbody> <tr><td>WIDTH:</td><td>21.0 25.0</td></tr> <tr><td>DEPTH:</td><td>26.0 26.0</td></tr> <tr><td>HEIGHT:</td><td>34.0 34.0</td></tr> <tr><td>SEAT WIDTH:</td><td>18.0 18.0</td></tr> <tr><td>SEAT DEPTH:</td><td>16.0 16.0</td></tr> <tr><td>SEAT HEIGHT:</td><td>18.5 18.5</td></tr> <tr><td>BACK WIDTH:</td><td>19.0 19.0</td></tr> <tr><td>BACK HEIGHT:</td><td>17.5 17.5</td></tr> <tr><td>COM:</td><td>N/A N/A</td></tr> <tr><td>WEIGHT:</td><td>13.0 LB 15.0 LB</td></tr> </tbody> </table>	WIDTH:	21.0 25.0	DEPTH:	26.0 26.0	HEIGHT:	34.0 34.0	SEAT WIDTH:	18.0 18.0	SEAT DEPTH:	16.0 16.0	SEAT HEIGHT:	18.5 18.5	BACK WIDTH:	19.0 19.0	BACK HEIGHT:	17.5 17.5	COM:	N/A N/A	WEIGHT:	13.0 LB 15.0 LB	<table border="1"> <tbody> <tr> <td>GC1 Ganging Clip - 2 per set GC1 - Armless-to-Armless \$30</td> <td>GC2 Ganging Clip - 2 per set GC2 - Arm-to-Arm \$30</td> </tr> </tbody> </table>	GC1 Ganging Clip - 2 per set GC1 - Armless-to-Armless \$30	GC2 Ganging Clip - 2 per set GC2 - Arm-to-Arm \$30						
WIDTH:	21.0 25.0																																		
DEPTH:	26.0 26.0																																		
HEIGHT:	34.0 34.0																																		
SEAT WIDTH:	18.0 18.0																																		
SEAT DEPTH:	16.0 16.0																																		
SEAT HEIGHT:	18.5 18.5																																		
BACK WIDTH:	19.0 19.0																																		
BACK HEIGHT:	17.5 17.5																																		
COM:	N/A N/A																																		
WEIGHT:	13.0 LB 15.0 LB																																		
GC1 Ganging Clip - 2 per set GC1 - Armless-to-Armless \$30	GC2 Ganging Clip - 2 per set GC2 - Arm-to-Arm \$30																																		
1365	GT	GUEST STACKING WITH CASTERS Mesh back with plastic seat.	ARMLESS A12 A14 TAB-A00 TAB-A12 TAB-A14	P 320 365 400 440 465 480	<ul style="list-style-type: none"> • 50mm Hooded Casters • Stack 4 High on Floor • Stacks 10 High on Optional Dolly • Choice of 6 Mesh Back Colors • Rated for 250 lbs 	<table border="1"> <tbody> <tr><td>WIDTH:</td><td>21.0 25.0</td></tr> <tr><td>DEPTH:</td><td>26.0 26.0</td></tr> <tr><td>HEIGHT:</td><td>34.0 34.0</td></tr> <tr><td>SEAT WIDTH:</td><td>18.0 18.0</td></tr> <tr><td>SEAT DEPTH:</td><td>16.0 16.0</td></tr> <tr><td>SEAT HEIGHT:</td><td>18.5 18.5</td></tr> <tr><td>BACK WIDTH:</td><td>19.0 19.0</td></tr> <tr><td>BACK HEIGHT:</td><td>17.5 17.5</td></tr> <tr><td>COM:</td><td>N/A N/A</td></tr> <tr><td>WEIGHT:</td><td>13.0 LB 15.0 LB</td></tr> </tbody> </table>	WIDTH:	21.0 25.0	DEPTH:	26.0 26.0	HEIGHT:	34.0 34.0	SEAT WIDTH:	18.0 18.0	SEAT DEPTH:	16.0 16.0	SEAT HEIGHT:	18.5 18.5	BACK WIDTH:	19.0 19.0	BACK HEIGHT:	17.5 17.5	COM:	N/A N/A	WEIGHT:	13.0 LB 15.0 LB	<p>CAUTION: Careless stacking of chairs may scratch and damage frames.</p> <p>MESH COLORS</p> <table border="1"> <tbody> <tr> <td>BLACK M11</td> <td>GRAY M12</td> <td>SILVER M13</td> <td>GREEN M14</td> <td>RED M15</td> <td>BLUE M16</td> </tr> </tbody> </table>	BLACK M11	GRAY M12	SILVER M13	GREEN M14	RED M15	BLUE M16		
WIDTH:	21.0 25.0																																		
DEPTH:	26.0 26.0																																		
HEIGHT:	34.0 34.0																																		
SEAT WIDTH:	18.0 18.0																																		
SEAT DEPTH:	16.0 16.0																																		
SEAT HEIGHT:	18.5 18.5																																		
BACK WIDTH:	19.0 19.0																																		
BACK HEIGHT:	17.5 17.5																																		
COM:	N/A N/A																																		
WEIGHT:	13.0 LB 15.0 LB																																		
BLACK M11	GRAY M12	SILVER M13	GREEN M14	RED M15	BLUE M16																														

ONLY AVAILABLE IN M1

ONLY AVAILABLE IN M1

*Standard twenty five (25) business days applies only to Metallic Brown, Gunmetal, Dover Gray and White frame color options.

bella

name your game, bella is ready to play

ALL PLASTIC - AP

GSA SIN # 711-19

- Back styles include: all plastic, upholstered, or mesh back
- Choice of plastic or upholstered seat
- 6 powder coated frame finishes
- Seat flips up for nesting
- Warranted up to 250 lbs
- CAL TB 133 Fire Code approved



CREATING BELLA MODEL NUMBER

MODEL NUMBER CONTROL ARMS FRAME COLOR UPHOLSTERY MESH COLOR GRADE CASTERS PACKAGING OPTIONS

1 3 - G T - A - P - M - P - C 5

* FOR ARMLESS CODE USE ADD * ONLY SELECT FOR MODEL 1370

FRAME COLORS

BLACK BF	SILVER SF	METALLIC BROWN* MBF
GUNMETAL* GMF	DOVER GRAY* DGF	WHITE* WF

PACKAGING NOTES

CODE	DESCRIPTION	LIST UPCHARGE
AB	ASSEMBLED IN BAG FOR WILL CALL	\$0
AC	ASSEMBLED IN CARTON	\$0

BELLA NESTING CHAIRS SHIP UP TO 2 PER CARTON

MODEL	CONTROL	DESCRIPTION	ARM	PLASTIC	FEATURES	DIMENSIONS	ARM OPTIONS	CASTER OPTIONS																																		
1320	GT	GUEST NESTING Plastic back with plastic seat.	ARMLESS A12 A14	P 275 320 355	<ul style="list-style-type: none"> • Flip Up Seat for Nesting and Compact Storage • 50mm Hooded Casters • Integrated Handle in Back of Chair • Rated for 250 lbs 	<table border="1"> <tr> <th>ARMLESS</th> <th>W/ ARMS</th> </tr> <tr> <td>WIDTH: 21.0</td> <td>25.0</td> </tr> <tr> <td>DEPTH: 26.0</td> <td>26.0</td> </tr> <tr> <td>HEIGHT: 34.0</td> <td>34.0</td> </tr> <tr> <td>SEAT WIDTH: 18.0</td> <td>18.0</td> </tr> <tr> <td>SEAT DEPTH: 16.0</td> <td>16.0</td> </tr> <tr> <td>SEAT HEIGHT: 18.5</td> <td>18.5</td> </tr> <tr> <td>BACK WIDTH: 19.0</td> <td>19.0</td> </tr> <tr> <td>BACK HEIGHT: 17.5</td> <td>17.5</td> </tr> <tr> <td>COM: N/A</td> <td>N/A</td> </tr> <tr> <td>WEIGHT: 19.0 LB</td> <td>22.0 LB</td> </tr> </table>	ARMLESS	W/ ARMS	WIDTH: 21.0	25.0	DEPTH: 26.0	26.0	HEIGHT: 34.0	34.0	SEAT WIDTH: 18.0	18.0	SEAT DEPTH: 16.0	16.0	SEAT HEIGHT: 18.5	18.5	BACK WIDTH: 19.0	19.0	BACK HEIGHT: 17.5	17.5	COM: N/A	N/A	WEIGHT: 19.0 LB	22.0 LB	<table border="1"> <tr> <th>ARM OPTIONS</th> <th>PRICE</th> </tr> <tr> <td> Fixed Arm</td> <td>A12 \$45</td> </tr> <tr> <td> Reinforced Soft Touch Extended Arm</td> <td>A14 \$80</td> </tr> </table>	ARM OPTIONS	PRICE	Fixed Arm	A12 \$45	Reinforced Soft Touch Extended Arm	A14 \$80	<table border="1"> <tr> <th>CASTER OPTIONS</th> <th>PRICE</th> </tr> <tr> <td> Standard 50mm Hooded Casters</td> <td>C5 STD</td> </tr> <tr> <td> 50mm Hooded Hard Floor Casters</td> <td>C5S \$30</td> </tr> </table>	CASTER OPTIONS	PRICE	Standard 50mm Hooded Casters	C5 STD	50mm Hooded Hard Floor Casters	C5S \$30
ARMLESS	W/ ARMS																																									
WIDTH: 21.0	25.0																																									
DEPTH: 26.0	26.0																																									
HEIGHT: 34.0	34.0																																									
SEAT WIDTH: 18.0	18.0																																									
SEAT DEPTH: 16.0	16.0																																									
SEAT HEIGHT: 18.5	18.5																																									
BACK WIDTH: 19.0	19.0																																									
BACK HEIGHT: 17.5	17.5																																									
COM: N/A	N/A																																									
WEIGHT: 19.0 LB	22.0 LB																																									
ARM OPTIONS	PRICE																																									
Fixed Arm	A12 \$45																																									
Reinforced Soft Touch Extended Arm	A14 \$80																																									
CASTER OPTIONS	PRICE																																									
Standard 50mm Hooded Casters	C5 STD																																									
50mm Hooded Hard Floor Casters	C5S \$30																																									
1370	GT	GUEST NESTING Mesh back with plastic seat.	ARMLESS A12 A14	P 340 385 420	<ul style="list-style-type: none"> • Flip Up Seat for Nesting and Compact Storage • 50mm Hooded Casters • Choice of 6 Mesh Back Colors • Rated for 250 lbs 	<table border="1"> <tr> <th>ARMLESS</th> <th>W/ ARMS</th> </tr> <tr> <td>WIDTH: 21.0</td> <td>25.0</td> </tr> <tr> <td>DEPTH: 26.0</td> <td>26.0</td> </tr> <tr> <td>HEIGHT: 34.0</td> <td>34.0</td> </tr> <tr> <td>SEAT WIDTH: 18.0</td> <td>18.0</td> </tr> <tr> <td>SEAT DEPTH: 16.0</td> <td>16.0</td> </tr> <tr> <td>SEAT HEIGHT: 18.5</td> <td>18.5</td> </tr> <tr> <td>BACK WIDTH: 19.0</td> <td>19.0</td> </tr> <tr> <td>BACK HEIGHT: 17.5</td> <td>17.5</td> </tr> <tr> <td>COM: N/A</td> <td>N/A</td> </tr> <tr> <td>WEIGHT: 19.0 LB</td> <td>22.0 LB</td> </tr> </table>	ARMLESS	W/ ARMS	WIDTH: 21.0	25.0	DEPTH: 26.0	26.0	HEIGHT: 34.0	34.0	SEAT WIDTH: 18.0	18.0	SEAT DEPTH: 16.0	16.0	SEAT HEIGHT: 18.5	18.5	BACK WIDTH: 19.0	19.0	BACK HEIGHT: 17.5	17.5	COM: N/A	N/A	WEIGHT: 19.0 LB	22.0 LB	<table border="1"> <tr> <th>ARM OPTIONS</th> <th>PRICE</th> </tr> <tr> <td> Fixed Arm</td> <td>A12 \$45</td> </tr> <tr> <td> Reinforced Soft Touch Extended Arm</td> <td>A14 \$80</td> </tr> </table>	ARM OPTIONS	PRICE	Fixed Arm	A12 \$45	Reinforced Soft Touch Extended Arm	A14 \$80	<table border="1"> <tr> <th>CASTER OPTIONS</th> <th>PRICE</th> </tr> <tr> <td> Standard 50mm Hooded Casters</td> <td>C5 STD</td> </tr> <tr> <td> 50mm Hooded Hard Floor Casters</td> <td>C5S \$30</td> </tr> </table>	CASTER OPTIONS	PRICE	Standard 50mm Hooded Casters	C5 STD	50mm Hooded Hard Floor Casters	C5S \$30
ARMLESS	W/ ARMS																																									
WIDTH: 21.0	25.0																																									
DEPTH: 26.0	26.0																																									
HEIGHT: 34.0	34.0																																									
SEAT WIDTH: 18.0	18.0																																									
SEAT DEPTH: 16.0	16.0																																									
SEAT HEIGHT: 18.5	18.5																																									
BACK WIDTH: 19.0	19.0																																									
BACK HEIGHT: 17.5	17.5																																									
COM: N/A	N/A																																									
WEIGHT: 19.0 LB	22.0 LB																																									
ARM OPTIONS	PRICE																																									
Fixed Arm	A12 \$45																																									
Reinforced Soft Touch Extended Arm	A14 \$80																																									
CASTER OPTIONS	PRICE																																									
Standard 50mm Hooded Casters	C5 STD																																									
50mm Hooded Hard Floor Casters	C5S \$30																																									
				ONLY AVAILABLE IN M1																																						
									<h4>NESTING FOOTPRINT</h4> <p>First Chair 24", Each Additional Chair, Add 6"</p>																																	
									<h4>ACCESSORIES</h4> <p>CAUTION: Careless nesting of chairs may scratch and damage frames.</p>																																	
									<h4>MESH COLORS</h4> <table border="1"> <tr> <td>BLACK M11</td> <td>GRAY M12</td> <td>SILVER M13</td> <td>GREEN M14</td> <td>RED M15</td> <td>BLUE M16</td> </tr> </table>	BLACK M11	GRAY M12	SILVER M13	GREEN M14	RED M15	BLUE M16																											
BLACK M11	GRAY M12	SILVER M13	GREEN M14	RED M15	BLUE M16																																					

*Standard twenty five (25) business days applies only to Metallic Brown, Gunmetal, Dover Gray and White frame color options.

bella

name your game, bella is ready to play

ALL PLASTIC - AP

GSA SIN # 711-18

- Training, task, multipurpose, stool, management and conference seating
- Back styles include: all plastic, upholstered, or mesh back
- Choice of plastic or upholstered seat
- 6 powder coated frame finishes
- Warranted up to 250 lbs
- CAL TB 133 Fire Code approved



CREATING BELLA MODEL NUMBER

MODEL NUMBER CONTROL ARMS FRAME COLOR UPHOLSTERY MESH COLOR GRADE CASTERS PACKAGING OPTIONS

1 3 5 - - A - - - A P - M - - P - C 6 - - - -

* FOR ARMLESS CODE USE ADD * ONLY SELECT FOR MODELS 1375

FRAME COLORS

BLACK BF	SILVER SF	METALLIC BROWN* MBF
GUNMETAL* GMF	DOVER GRAY* DGF	WHITE* WF

PACKAGING NOTES

CODE	DESCRIPTION	LIST UPCHARGE
AB	ASSEMBLED IN BAG FOR WILL CALL	\$0
BAC	ASSEMBLED IN CARTON	\$0

MODEL	CONTROL	DESCRIPTION	ARM	PLASTIC	FEATURES	DIMENSIONS	ARM OPTIONS	CASTER OPTIONS
1325	B2	LOW-BACK BASIC CONTROL Plastic back with plastic seat.	ARMLESS A12 A14	P 335 380 415	<ul style="list-style-type: none"> • Pneumatic Seat Height Adjustment • Basic Control Swivels 360 Degrees • Rated for 250 lbs 	WIDTH: 25.0 DEPTH: 26.0 HEIGHT: 34.0-38.5 SEAT WIDTH: 18.0 SEAT DEPTH: 16.0 SEAT HEIGHT: 18.5-23.0 BACK WIDTH: 19.0 BACK HEIGHT: 17.5 COM: N/A WEIGHT: 24.5 LB	Fixed Arm Reinforced Soft Touch Extended Arm	Standard 60mm Hoodless Casters 60mm Hoodless Hard Floor Casters
1325	S3	LOW-BACK SWIVEL TILT CONTROL Plastic back with plastic seat.	ARMLESS A12 A14	P 370 415 450	<ul style="list-style-type: none"> • Pneumatic Seat Height Adjustment • Tilt Tension Control • Seat and Back Tilt as a Unit • Upright Position Tilt Lock • Rated for 250 lbs 	WIDTH: 25.0 DEPTH: 26.0 HEIGHT: 34.0-38.5 SEAT WIDTH: 18.0 SEAT DEPTH: 16.0 SEAT HEIGHT: 17.0-21.5 BACK WIDTH: 19.0 BACK HEIGHT: 17.5 COM: N/A WEIGHT: 25.5 LB		
1375	B2	LOW-BACK BASIC CONTROL Mesh back with plastic seat.	ARMLESS A12 A14	P 400 445 480	<ul style="list-style-type: none"> • Pneumatic Seat Height Adjustment • Basic Control Swivels 360 Degrees • Choice of 6 Mesh Back Colors • Rated for 250 lbs 	WIDTH: 25.0 DEPTH: 26.0 HEIGHT: 34.0-38.5 SEAT WIDTH: 18.0 SEAT DEPTH: 16.0 SEAT HEIGHT: 18.5-23.0 BACK WIDTH: 19.0 BACK HEIGHT: 17.5 COM: N/A WEIGHT: 24.5 LB		
1375	S3	LOW-BACK SWIVEL TILT CONTROL Mesh back with plastic seat.	ARMLESS A12 A14	P 435 480 515	<ul style="list-style-type: none"> • Pneumatic Seat Height Adjustment • Tilt Tension Control • Seat and Back Tilt as a Unit • Upright Position Tilt Lock • Choice of 6 Mesh Back Colors • Rated for 250 lbs 	WIDTH: 25.0 DEPTH: 26.0 HEIGHT: 34.0-38.5 SEAT WIDTH: 18.0 SEAT DEPTH: 16.0 SEAT HEIGHT: 17.0-21.5 BACK WIDTH: 19.0 BACK HEIGHT: 17.5 COM: N/A WEIGHT: 25.5 LB		

ADDITIONAL OPTIONS



26" High Profile Aluminum
 BA10B - Black Powder-Coat
 BA10P - Polished
 BA10S - Silver Powder-Coat

MESH COLORS

BLACK M11	GRAY M12	SILVER M13	GREEN M14	RED M15	BLUE M16
--------------	-------------	---------------	--------------	------------	-------------

*Standard twenty five (25) business days applies only to Metallic Brown, Gunmetal, Dover Gray and White frame color options.

bella

name your game, bella is ready to play

ALL PLASTIC - AP

GSA SIN # 711-18

- Training, task, multipurpose, stool, management and conference seating
- Back styles include: all plastic, upholstered, or mesh back
- Choice of plastic or upholstered seat
- 6 powder coated frame finishes
- Warranted up to 250 lbs
- CAL TB 133 Fire Code approved



CREATING BELLA MODEL NUMBER

MODEL NUMBER	CONTROL	ARMS	FRAME COLOR	UPHOLSTERY	MESH COLOR	GRADE	CASTERS	PACKAGING	OPTIONS
132	B2	A		AP	M		P6		

* FOR ARMLESS CODE USE A00 * ONLY SELECT FOR MODELS 1376/1378

FRAME COLORS

BLACK BF	SILVER SF	METALLIC BROWN* MBF
GUNMETAL* GMF	DOVER GRAY* DGF	WHITE* WF

PACKAGING NOTES

CODE	DESCRIPTION	LIST UPCHARGE
AB	ASSEMBLED IN BAG FOR WILL CALL	\$0
BAC	ASSEMBLED IN CARTON	\$0

MODEL	CONTROL	DESCRIPTION	ARM	PLASTIC	FEATURES	DIMENSIONS	ARM OPTIONS	CASTER OPTIONS
1326	B2	10" TRAVEL HIGH STOOL BASIC CONTROL Use for work surfaces up to 42 inches high. Plastic back with plastic seat.	ARMLESS A12 A14	P 460 505 540	<ul style="list-style-type: none"> • Pneumatic Seat Height Adjustment • Height Adj 20" Diameter Footring • Rated for 250 lbs 	WIDTH: 25.0 DEPTH: 26.0 HEIGHT: 40.5-50.5 SEAT WIDTH: 18.0 SEAT DEPTH: 16.0 SEAT HEIGHT: 23.5-33.5 BACK WIDTH: 19.0 BACK HEIGHT: 17.5 COM: N/A WEIGHT: 30.5 LB		
1328	B2	8" TRAVEL LOW STOOL BASIC CONTROL Use for work surfaces up to 36 inches high. Plastic back with plastic seat.	ARMLESS A12 A14	P 460 505 540	<ul style="list-style-type: none"> • Pneumatic Seat Height Adjustment • Height Adj 20" Diameter Footring • Rated for 250 lbs 	WIDTH: 25.0 DEPTH: 26.0 HEIGHT: 36.5-44.5 SEAT WIDTH: 18.0 SEAT DEPTH: 16.0 SEAT HEIGHT: 19.5-27.5 BACK WIDTH: 19.0 BACK HEIGHT: 17.5 COM: N/A WEIGHT: 29.5 LB		
1376	B2	10" TRAVEL HIGH STOOL BASIC CONTROL Use for work surfaces up to 42 inches high. Mesh back with plastic seat.	ARMLESS A12 A14	P 525 570 605	<ul style="list-style-type: none"> • Pneumatic Seat Height Adjustment • Height Adj 20" Diameter Footring • Choice of 6 Mesh Back Colors • Rated for 250 lbs 	WIDTH: 25.0 DEPTH: 26.0 HEIGHT: 40.5-50.5 SEAT WIDTH: 18.0 SEAT DEPTH: 16.0 SEAT HEIGHT: 23.5-33.5 BACK WIDTH: 19.0 BACK HEIGHT: 17.5 COM: N/A WEIGHT: 30.5 LB		
1378	B2	8" TRAVEL LOW STOOL BASIC CONTROL Use for work surfaces up to 36 inches high. Mesh back with plastic seat.	ARMLESS A12 A14	P 525 570 605	<ul style="list-style-type: none"> • Pneumatic Seat Height Adjustment • Height Adj 20" Diameter Footring • Choice of 6 Mesh Back Colors • Rated for 250 lbs 	WIDTH: 25.0 DEPTH: 26.0 HEIGHT: 36.5-44.5 SEAT WIDTH: 18.0 SEAT DEPTH: 16.0 SEAT HEIGHT: 19.5-27.5 BACK WIDTH: 19.0 BACK HEIGHT: 17.5 COM: N/A WEIGHT: 29.5 LB		

ADDITIONAL OPTIONS



26" High Profile Aluminum
 BA10B - Black Powder-Coat
 BA10P - Polished
 BA10S - Silver Powder-Coat

MESH COLORS

BLACK M11	GRAY M12	SILVER M13	GREEN M14	RED M15	BLUE M16
--------------	-------------	---------------	--------------	------------	-------------

*Standard twenty five (25) business days applies only to Metallic Brown, Gunmetal, Dover Gray and White frame color options.

bella

name your game, bella is ready to play

UPHOLSTERED SEAT - US

GSA SIN # 711-19

- Back styles include: all plastic, upholstered, or mesh back
- Choice of plastic or upholstered seat
- Right hand tablet arm available with optional basket
- 6 powder coated frame finishes
- Warranted up to 250 lbs
- CAL TB 133 Fire Code approved



CREATING BELLA MODEL NUMBER

MODEL NUMBER CONTROL ARMS FRAME COLOR UPHOLSTERY MESH COLOR GRADE CASTERS PACKAGING OPTIONS

1 3 - G T - U S - M - C 5

* FOR ARMLESS CODE USE A00 * ONLY SELECT FOR MODELS 1360/1365 * ONLY SELECT CASTER CODE FOR MODELS 1315/1365

FRAME COLORS

BLACK BF	SILVER SF	METALLIC BROWN* MBF
GUNMETAL* GMF	DOVER GRAY* DGF	WHITE* WF

PACKAGING NOTES

CODE	DESCRIPTION	LIST UPCHARGE
AB	ASSEMBLED IN BAG FOR WILL CALL	\$0
AC	ASSEMBLED IN CARTON	\$0

BELLA STACK CHAIRS SHIP UP TO 3 PER CARTON

NOTE: Due to the nature of vinyl upholstery, stacking may cause impressions on the seat. 9to5 Seating does not warrant the effects of the stacking on vinyl upholstery.

MODEL	CONTROL	DESCRIPTION	ARM	FABRIC	FEATURES	DIMENSIONS	ARM OPTIONS	CASTER OPTIONS							
1310	GT	GUEST STACKING Plastic back with upholstered seat.	ARMLESS	A/COM: 260	B: 285	C: 305	D: 330	E: 360	F: 395	G: 430	<ul style="list-style-type: none"> • Non-Marring Floor Glides • Stack 4 High on Floor • Stacks 10 High on Optional Dolly • Wall Saver Back Legs • Integrated Handle in Back of Chair • Rated for 250 lbs. 	ARMLESS WIDTH: 21.0 DEPTH: 26.0 HEIGHT: 34.0 SEAT WIDTH: 18.0 SEAT DEPTH: 16.0 SEAT HEIGHT: 18.5 BACK WIDTH: 19.0 BACK HEIGHT: 17.5 COM: 0.8 YDS WEIGHT: 15.0 LB	A12 \$45 A14 \$80 C5 STD		
			A12	305	330	350	375	405	440	475					
			A14	340	365	385	410	440	475	510					
			TAB-A00	380	405	425	450	480	515	550					
			TAB-A12	405	430	450	475	505	540	575					
			TAB-A14	420	445	465	490	520	555	590					
1315	GT	GUEST STACKING WITH CASTERS Plastic back with upholstered seat.	ARMLESS	A/COM: 305	B: 330	C: 350	D: 375	E: 405	F: 440	G: 475	<ul style="list-style-type: none"> • 50mm Hooded Casters • Stack 4 High on Floor • Stacks 10 High on Optional Dolly • Integrated Handle in Back of Chair • Rated for 250 lbs. 	W/ ARMS WIDTH: 21.0 DEPTH: 26.0 HEIGHT: 34.0 SEAT WIDTH: 18.0 SEAT DEPTH: 16.0 SEAT HEIGHT: 18.5 BACK WIDTH: 19.0 BACK HEIGHT: 17.5 COM: 0.8 YDS WEIGHT: 17.0 LB	TAB-A00 \$120 TAB-A14 \$160 C5S \$30		
			A12	350	375	395	420	450	485	520				555	
			A14	385	410	430	455	485	520	555					
			TAB-A00	425	450	470	495	525	560	595					
			TAB-A12	450	475	495	520	550	585	620					
			TAB-A14	465	490	510	535	565	600	635					
1360	GT	GUEST STACKING Mesh back with upholstered seat.	ARMLESS	A/COM: 325	B: 350	C: 370	D: 395	E: 425	F: 460	G: 495	<ul style="list-style-type: none"> • Non-Marring Floor Glides • Stack 4 High on Floor • Stacks 10 High on Optional Dolly • Wall Saver Back Legs • Choice of 6 Mesh Back Colors • Rated for 250 lbs. 	W/ ARMS WIDTH: 21.0 DEPTH: 26.0 HEIGHT: 34.0 SEAT WIDTH: 18.0 SEAT DEPTH: 16.0 SEAT HEIGHT: 18.5 BACK WIDTH: 19.0 BACK HEIGHT: 17.5 COM: 0.8 YDS WEIGHT: 17.0 LB	BSK \$60 DL1 \$250 GC1 \$30 GC2 \$30		
			A12	370	395	415	440	470	505	540					
			A14	405	430	450	475	505	540	575					
			TAB-A00	445	470	490	515	545	580	615					
			TAB-A12	470	495	515	540	570	605	640					
			TAB-A14	485	510	530	555	585	620	655					
1365	GT	GUEST STACKING WITH CASTERS Mesh back with upholstered seat.	ARMLESS	A/COM: 370	B: 395	C: 415	D: 440	E: 470	F: 505	G: 540	<ul style="list-style-type: none"> • 50mm Hooded Casters • Stack 4 High on Floor • Stacks 10 High on Optional Dolly • Choice of 6 Mesh Back Colors • Rated for 250 lbs. 	W/ ARMS WIDTH: 21.0 DEPTH: 26.0 HEIGHT: 34.0 SEAT WIDTH: 18.0 SEAT DEPTH: 16.0 SEAT HEIGHT: 18.5 BACK WIDTH: 19.0 BACK HEIGHT: 17.5 COM: 0.8 YDS WEIGHT: 17.0 LB	GC1 \$30 GC2 \$30		
			A12	415	440	460	485	515	550	585					
			A14	450	475	495	520	550	585	620					
			TAB-A00	490	515	535	560	590	625	660					
			TAB-A12	515	540	560	585	615	650	685					
			TAB-A14	530	555	575	600	630	665	700					

ONLY AVAILABLE IN M1

ONLY AVAILABLE IN M1

CAUTION: Careless stacking of chairs may scratch and damage frames.

MESH COLORS

BLACK M11	GRAY M12	SILVER M13	GREEN M14	RED M15	BLUE M16
--------------	-------------	---------------	--------------	------------	-------------

*Standard twenty five (25) business days applies only to Metallic Brown, Gunmetal, Dover Gray and White frame color options.

bella

name your game, bella is ready to play

UPHOLSTERED SEAT - US

GSA SIN # 711-19

- Back styles include: all plastic, upholstered, or mesh back
- Choice of plastic or upholstered seat
- 6 powder coated frame finishes
- Seat flips up for nesting
- Warranted up to 250 lbs
- CAL TB 133 Fire Code approved



CREATING BELLA MODEL NUMBER

MODEL NUMBER CONTROL ARMS FRAME COLOR UPHOLSTERY MESH COLOR GRADE CASTERS PACKAGING OPTIONS

1 3 - G T - A - U S - M - C 5

* FOR ARMLESS CODE USE ADD * ONLY SELECT FOR MODEL 1370

FRAME COLORS

BLACK BF	SILVER SF	METALLIC BROWN* MBF
GUNMETAL* GMF	DOVER GRAY* DGF	WHITE* WF

PACKAGING NOTES

CODE	DESCRIPTION	LIST UPCHARGE
AB	ASSEMBLED IN BAG FOR WILL CALL	\$0
AC	ASSEMBLED IN CARTON	\$0

BELLA NESTING CHAIRS SHIP UP TO 2 PER CARTON

MODEL	CONTROL	DESCRIPTION	ARM	FABRIC	FEATURES	DIMENSIONS	ARM OPTIONS	CASTER OPTIONS																																																									
1320	GT	GUEST NESTING Plastic back with upholstered seat.	ARMLESS A12 A14	<table border="1"> <thead> <tr> <th>A/COM</th> <th>B</th> <th>C</th> <th>D</th> <th>E</th> <th>F</th> <th>G</th> </tr> </thead> <tbody> <tr> <td>325</td> <td>350</td> <td>370</td> <td>395</td> <td>425</td> <td>460</td> <td>495</td> </tr> <tr> <td>370</td> <td>395</td> <td>415</td> <td>440</td> <td>470</td> <td>505</td> <td>540</td> </tr> <tr> <td>405</td> <td>430</td> <td>450</td> <td>475</td> <td>505</td> <td>540</td> <td>575</td> </tr> </tbody> </table>	A/COM	B	C	D	E	F	G	325	350	370	395	425	460	495	370	395	415	440	470	505	540	405	430	450	475	505	540	575	<ul style="list-style-type: none"> • Flip Up Seat for Nesting and Compact Storage • 50mm Hooded Casters • Integrated Handle in Back of Chair • Rated for 250 lbs 	<table border="1"> <thead> <tr> <th>ARMLESS</th> <th>W/ ARMS</th> </tr> </thead> <tbody> <tr> <td>WIDTH: 21.0</td> <td>25.0</td> </tr> <tr> <td>DEPTH: 26.0</td> <td>26.0</td> </tr> <tr> <td>HEIGHT: 34.0</td> <td>34.0</td> </tr> <tr> <td>SEAT WIDTH: 18.0</td> <td>18.0</td> </tr> <tr> <td>SEAT DEPTH: 16.0</td> <td>16.0</td> </tr> <tr> <td>SEAT HEIGHT: 18.5</td> <td>18.5</td> </tr> <tr> <td>BACK WIDTH: 19.0</td> <td>19.0</td> </tr> <tr> <td>BACK HEIGHT: 17.5</td> <td>17.5</td> </tr> <tr> <td>COM: 0.8 YDS</td> <td>0.8 YDS</td> </tr> <tr> <td>WEIGHT: 21.0 LB</td> <td>24.0 LB</td> </tr> </tbody> </table>	ARMLESS	W/ ARMS	WIDTH: 21.0	25.0	DEPTH: 26.0	26.0	HEIGHT: 34.0	34.0	SEAT WIDTH: 18.0	18.0	SEAT DEPTH: 16.0	16.0	SEAT HEIGHT: 18.5	18.5	BACK WIDTH: 19.0	19.0	BACK HEIGHT: 17.5	17.5	COM: 0.8 YDS	0.8 YDS	WEIGHT: 21.0 LB	24.0 LB	<p>A12 \$45 Fixed Arm</p> <p>A14 \$80 Reinforced Soft Touch Extended Arm</p> <p>C5 STD Standard 50mm Hooded Casters</p> <p>C5S \$30 50mm Hooded Hard Floor Casters</p>								
A/COM	B	C	D	E	F	G																																																											
325	350	370	395	425	460	495																																																											
370	395	415	440	470	505	540																																																											
405	430	450	475	505	540	575																																																											
ARMLESS	W/ ARMS																																																																
WIDTH: 21.0	25.0																																																																
DEPTH: 26.0	26.0																																																																
HEIGHT: 34.0	34.0																																																																
SEAT WIDTH: 18.0	18.0																																																																
SEAT DEPTH: 16.0	16.0																																																																
SEAT HEIGHT: 18.5	18.5																																																																
BACK WIDTH: 19.0	19.0																																																																
BACK HEIGHT: 17.5	17.5																																																																
COM: 0.8 YDS	0.8 YDS																																																																
WEIGHT: 21.0 LB	24.0 LB																																																																
1370	GT	GUEST NESTING Mesh back with upholstered seat.	ARMLESS A12 A14	<table border="1"> <thead> <tr> <th>A/COM</th> <th>B</th> <th>C</th> <th>D</th> <th>E</th> <th>F</th> <th>G</th> </tr> </thead> <tbody> <tr> <td>390</td> <td>415</td> <td>435</td> <td>460</td> <td>490</td> <td>525</td> <td>560</td> </tr> <tr> <td>435</td> <td>460</td> <td>480</td> <td>505</td> <td>535</td> <td>570</td> <td>605</td> </tr> <tr> <td>470</td> <td>495</td> <td>515</td> <td>540</td> <td>570</td> <td>605</td> <td>640</td> </tr> </tbody> </table>	A/COM	B	C	D	E	F	G	390	415	435	460	490	525	560	435	460	480	505	535	570	605	470	495	515	540	570	605	640	<ul style="list-style-type: none"> • Flip Up Seat for Nesting and Compact Storage • 50mm Hooded Caster • Choice of 6 Mesh Back Colors • Rated for 250 lbs 	<table border="1"> <thead> <tr> <th>WIDTH:</th> <th>DEPTH:</th> <th>HEIGHT:</th> <th>SEAT WIDTH:</th> <th>SEAT DEPTH:</th> <th>SEAT HEIGHT:</th> <th>BACK WIDTH:</th> <th>BACK HEIGHT:</th> <th>COM:</th> <th>WEIGHT:</th> </tr> </thead> <tbody> <tr> <td>21.0</td> <td>26.0</td> <td>34.0</td> <td>18.0</td> <td>16.0</td> <td>18.5</td> <td>19.0</td> <td>17.5</td> <td>0.8 YDS</td> <td>21.0 LB</td> </tr> <tr> <td>25.0</td> <td>26.0</td> <td>34.0</td> <td>18.0</td> <td>16.0</td> <td>18.5</td> <td>19.0</td> <td>17.5</td> <td>0.8 YDS</td> <td>24.0 LB</td> </tr> </tbody> </table>	WIDTH:	DEPTH:	HEIGHT:	SEAT WIDTH:	SEAT DEPTH:	SEAT HEIGHT:	BACK WIDTH:	BACK HEIGHT:	COM:	WEIGHT:	21.0	26.0	34.0	18.0	16.0	18.5	19.0	17.5	0.8 YDS	21.0 LB	25.0	26.0	34.0	18.0	16.0	18.5	19.0	17.5	0.8 YDS	24.0 LB	<p>NESTING FOOTPRINT</p> <p>First Chair 24", Each Additional Chair, Add 6"</p> <p>ACCESSORIES</p>
A/COM	B	C	D	E	F	G																																																											
390	415	435	460	490	525	560																																																											
435	460	480	505	535	570	605																																																											
470	495	515	540	570	605	640																																																											
WIDTH:	DEPTH:	HEIGHT:	SEAT WIDTH:	SEAT DEPTH:	SEAT HEIGHT:	BACK WIDTH:	BACK HEIGHT:	COM:	WEIGHT:																																																								
21.0	26.0	34.0	18.0	16.0	18.5	19.0	17.5	0.8 YDS	21.0 LB																																																								
25.0	26.0	34.0	18.0	16.0	18.5	19.0	17.5	0.8 YDS	24.0 LB																																																								

ONLY AVAILABLE IN M1

CAUTION: Careless nesting of chairs may scratch and damage frames.

MESH COLORS

BLACK M11	GRAY M12	SILVER M13	GREEN M14	RED M15	BLUE M16
--------------	-------------	---------------	--------------	------------	-------------

*Standard twenty five (25) business days applies only to Metallic Brown, Gunmetal, Dover Gray and White frame color options.

bella

name your game, bella is ready to play

UPHOLSTERED SEAT - US

GSA SIN # 711-18

- Training, task, multipurpose, stool, management and conference seating
- Back styles include: all plastic, upholstered, or mesh back
- Choice of plastic or upholstered seat
- 6 powder coated frame finishes
- Warranted up to 250 lbs
- CAL TB 133 Fire Code approved



CREATING BELLA MODEL NUMBER

MODEL NUMBER CONTROL ARMS FRAME COLOR UPHOLSTERY MESH COLOR GRADE CASTERS PACKAGING OPTIONS

1 3 5 - - A - - - U S - M - - - C 6 - - - - -

* FOR ARMLESS CODE USE ADD * ONLY SELECT FOR MODELS 1375

FRAME COLORS

BLACK BF	SILVER SF	METALLIC BROWN* MBF
GUNMETAL* GMF	DOVER GRAY* DGF	WHITE* WF

PACKAGING NOTES

CODE	DESCRIPTION	LIST UPCHARGE
AB	ASSEMBLED IN BAG FOR WILL CALL	\$0
BAC	ASSEMBLED IN CARTON	\$0

MODEL	CONTROL	DESCRIPTION	ARM	FABRIC	FEATURES	DIMENSIONS	ARM OPTIONS	CASTER OPTIONS						
1325	B2	LOW-BACK BASIC CONTROL Plastic back with upholstered seat.	ARMLESS	A/COM: 385, B: 410, C: 430, D: 455, E: 485, F: 520, G: 555	<ul style="list-style-type: none"> • Pneumatic Seat Height Adjustment • Basic Control Swivels 360 Degrees • Rated for 250 lbs 	WIDTH: 25.0 DEPTH: 26.0 HEIGHT: 34.0-38.5 SEAT WIDTH: 18.0 SEAT DEPTH: 16.0 SEAT HEIGHT: 18.5-23.0 BACK WIDTH: 19.0 BACK HEIGHT: 17.5 COM: 0.8 YDS WEIGHT: 26.5 LB	A12 \$45 A14 \$80	C6 STD C6S \$30						
	A12		A/COM: 430, B: 455, C: 475, D: 500, E: 530, F: 565, G: 600											
A14	A/COM: 465, B: 490, C: 510, D: 535, E: 565, F: 600, G: 635													
1325	S3	LOW-BACK SWIVEL TILT CONTROL Plastic back with upholstered seat.	ARMLESS	A/COM: 420, B: 445, C: 465, D: 490, E: 520, F: 555, G: 590	<ul style="list-style-type: none"> • Pneumatic Seat Height Adjustment • Tilt Tension Control • Seat and Back Tilt as a Unit • Upright Position Tilt Lock • Rated for 250 lbs 	WIDTH: 25.0 DEPTH: 26.0 HEIGHT: 34.0-38.5 SEAT WIDTH: 18.0 SEAT DEPTH: 16.0 SEAT HEIGHT: 17.0-21.5 BACK WIDTH: 19.0 BACK HEIGHT: 17.5 COM: 0.8 YDS WEIGHT: 27.5 LB								
	A12		A/COM: 465, B: 490, C: 510, D: 535, E: 565, F: 600, G: 635											
A14	A/COM: 500, B: 525, C: 545, D: 570, E: 600, F: 635, G: 670													
1375	B2	LOW-BACK BASIC CONTROL Mesh back with upholstered seat.	ARMLESS	A/COM: 450, B: 475, C: 495, D: 520, E: 550, F: 585, G: 620	<ul style="list-style-type: none"> • Pneumatic Seat Height Adjustment • Basic Control Swivels 360 Degrees • Choice of 6 Mesh Back Colors • Rated for 250 lbs 	WIDTH: 25.0 DEPTH: 26.0 HEIGHT: 34.0-38.5 SEAT WIDTH: 18.0 SEAT DEPTH: 16.0 SEAT HEIGHT: 18.5-23.0 BACK WIDTH: 19.0 BACK HEIGHT: 17.5 COM: 0.8 YDS WEIGHT: 26.5 LB	BA10B BA10P BA10S \$100 26" High Profile Aluminum Base BA10B - Black Powder-Coat BA10P - Polished BA10S - Silver Powder-Coat							
	A12		A/COM: 495, B: 520, C: 540, D: 565, E: 595, F: 630, G: 665											
A14	A/COM: 530, B: 555, C: 575, D: 600, E: 630, F: 665, G: 700													
				ONLY AVAILABLE IN M1										
1375	S3	LOW-BACK SWIVEL TILT CONTROL Mesh back with upholstered seat.	ARMLESS	A/COM: 485, B: 510, C: 530, D: 555, E: 585, F: 620, G: 655	<ul style="list-style-type: none"> • Pneumatic Seat Height Adjustment • Tilt Tension Control • Seat and Back Tilt as a Unit • Upright Position Tilt Lock • Choice of 6 Mesh Back Colors • Rated for 250 lbs 	WIDTH: 25.0 DEPTH: 26.0 HEIGHT: 34.0-38.5 SEAT WIDTH: 18.0 SEAT DEPTH: 16.0 SEAT HEIGHT: 17.0-21.5 BACK WIDTH: 19.0 BACK HEIGHT: 17.5 COM: 0.8 YDS WEIGHT: 27.5 LB		MESH COLORS <table border="1"> <tr> <td>BLACK M11</td> <td>GRAY M12</td> <td>SILVER M13</td> <td>GREEN M14</td> <td>RED M15</td> <td>BLUE M16</td> </tr> </table>	BLACK M11	GRAY M12	SILVER M13	GREEN M14	RED M15	BLUE M16
	BLACK M11		GRAY M12	SILVER M13					GREEN M14	RED M15	BLUE M16			
A12	A/COM: 530, B: 555, C: 575, D: 600, E: 630, F: 665, G: 700													
A14	A/COM: 565, B: 590, C: 610, D: 635, E: 665, F: 700, G: 735													
				ONLY AVAILABLE IN M1										

*Standard twenty five (25) business days applies only to Metallic Brown, Gunmetal, Dover Gray and White frame color options.

bella

name your game, bella is ready to play

UPHOLSTERED SEAT - US

GSA SIN # 711-18

- Training, task, multipurpose, stool, management and conference seating
- Back styles include: all plastic, upholstered, or mesh back
- Choice of plastic or upholstered seat
- 6 powder coated frame finishes
- Warranted up to 250 lbs
- CAL TB 133 Fire Code approved



CREATING BELLA MODEL NUMBER

MODEL NUMBER CONTROL ARMS FRAME COLOR UPHOLSTERY MESH COLOR GRADE CASTERS PACKAGING OPTIONS

1 3 2 - B 2 - A - - - U S - M - - - C 6 - - - - -

* FOR ARMLESS CODE USE ADD * ONLY SELECT FOR MODELS 1376/1378

FRAME COLORS

BLACK BF	SILVER SF	METALLIC BROWN* MBF
GUNMETAL* GMF	DOVER GRAY* DGF	WHITE* WF

PACKAGING NOTES

CODE	DESCRIPTION	LIST UPCHARGE
AB	ASSEMBLED IN BAG FOR WILL CALL	\$0
BAC	ASSEMBLED IN CARTON	\$0

MODEL	CONTROL	DESCRIPTION	ARM	FABRIC	FEATURES	DIMENSIONS	ARM OPTIONS	CASTER OPTIONS																																	
1326	B2	10" TRAVEL HIGH STOOL BASIC CONTROL Use for work surfaces up to 42 inches high. Plastic back with upholstered seat.	ARMLESS A12 A14	<table border="1"> <thead> <tr> <th>A/COM</th> <th>B</th> <th>C</th> <th>D</th> <th>E</th> <th>F</th> <th>G</th> </tr> </thead> <tbody> <tr> <td>510</td> <td>535</td> <td>555</td> <td>580</td> <td>610</td> <td>645</td> <td>680</td> </tr> <tr> <td>555</td> <td>580</td> <td>600</td> <td>625</td> <td>655</td> <td>690</td> <td>725</td> </tr> <tr> <td>590</td> <td>615</td> <td>635</td> <td>660</td> <td>690</td> <td>725</td> <td>760</td> </tr> </tbody> </table>	A/COM	B	C	D	E	F	G	510	535	555	580	610	645	680	555	580	600	625	655	690	725	590	615	635	660	690	725	760	<ul style="list-style-type: none"> • Pneumatic Seat Height Adjustment • Height Adj 20" Diameter Footring • Rated for 250 lbs 	WIDTH: 25.0 DEPTH: 26.0 HEIGHT: 40.5-50.5 SEAT WIDTH: 18.0 SEAT DEPTH: 16.0 SEAT HEIGHT: 23.5-33.5 BACK WIDTH: 19.0 BACK HEIGHT: 17.5 COM: 0.8 YDS WEIGHT: 32.5 LB	A12 \$45 A14 \$80 C6 STD C6S \$30						
A/COM	B	C	D	E	F	G																																			
510	535	555	580	610	645	680																																			
555	580	600	625	655	690	725																																			
590	615	635	660	690	725	760																																			
1328	B2	8" TRAVEL LOW STOOL BASIC CONTROL Use for work surfaces up to 36 inches high. Plastic back with upholstered seat.	ARMLESS A12 A14	<table border="1"> <thead> <tr> <th>A/COM</th> <th>B</th> <th>C</th> <th>D</th> <th>E</th> <th>F</th> <th>G</th> </tr> </thead> <tbody> <tr> <td>510</td> <td>535</td> <td>555</td> <td>580</td> <td>610</td> <td>645</td> <td>680</td> </tr> <tr> <td>555</td> <td>580</td> <td>600</td> <td>625</td> <td>655</td> <td>690</td> <td>725</td> </tr> <tr> <td>590</td> <td>615</td> <td>635</td> <td>660</td> <td>690</td> <td>725</td> <td>760</td> </tr> </tbody> </table>	A/COM	B	C	D	E	F	G	510	535	555	580	610	645	680	555	580	600	625	655	690	725	590	615	635	660	690	725	760	<ul style="list-style-type: none"> • Pneumatic Seat Height Adjustment • Height Adj 20" Diameter Footring • Rated for 250 lbs 	WIDTH: 25.0 DEPTH: 26.0 HEIGHT: 36.5-44.5 SEAT WIDTH: 18.0 SEAT DEPTH: 16.0 SEAT HEIGHT: 19.5-27.5 BACK WIDTH: 19.0 BACK HEIGHT: 17.5 COM: 0.8 YDS WEIGHT: 31.5 LB							
A/COM	B	C	D	E	F	G																																			
510	535	555	580	610	645	680																																			
555	580	600	625	655	690	725																																			
590	615	635	660	690	725	760																																			
1376	B2	10" TRAVEL HIGH STOOL BASIC CONTROL Use for work surfaces up to 42 inches high. Mesh back with upholstered seat.	ARMLESS A12 A14	<table border="1"> <thead> <tr> <th>A/COM</th> <th>B</th> <th>C</th> <th>D</th> <th>E</th> <th>F</th> <th>G</th> </tr> </thead> <tbody> <tr> <td>575</td> <td>600</td> <td>620</td> <td>645</td> <td>675</td> <td>710</td> <td>745</td> </tr> <tr> <td>620</td> <td>645</td> <td>665</td> <td>690</td> <td>720</td> <td>755</td> <td>790</td> </tr> <tr> <td>655</td> <td>680</td> <td>700</td> <td>725</td> <td>755</td> <td>790</td> <td>825</td> </tr> </tbody> </table>	A/COM	B	C	D	E	F	G	575	600	620	645	675	710	745	620	645	665	690	720	755	790	655	680	700	725	755	790	825	<ul style="list-style-type: none"> • Pneumatic Seat Height Adjustment • Height Adj 20" Diameter Footring • Choice of 6 Mesh Back Colors • Rated for 250 lbs 	WIDTH: 25.0 DEPTH: 26.0 HEIGHT: 40.5-50.5 SEAT WIDTH: 18.0 SEAT DEPTH: 16.0 SEAT HEIGHT: 23.5-33.5 BACK WIDTH: 19.0 BACK HEIGHT: 17.5 COM: 0.8 YDS WEIGHT: 32.5 LB	BA10B BA10P BA10S \$100 26" High Profile Aluminum Base BA10B - Black Powder-Coat BA10P - Polished BA10S - Silver Powder-Coat						
A/COM	B	C	D	E	F	G																																			
575	600	620	645	675	710	745																																			
620	645	665	690	720	755	790																																			
655	680	700	725	755	790	825																																			
1378	B2	8" TRAVEL LOW STOOL BASIC CONTROL Use for work surfaces up to 36 inches high. Mesh back with upholstered seat.	ARMLESS A12 A14	<table border="1"> <thead> <tr> <th>A/COM</th> <th>B</th> <th>C</th> <th>D</th> <th>E</th> <th>F</th> <th>G</th> </tr> </thead> <tbody> <tr> <td>575</td> <td>600</td> <td>620</td> <td>645</td> <td>675</td> <td>710</td> <td>745</td> </tr> <tr> <td>620</td> <td>645</td> <td>665</td> <td>690</td> <td>720</td> <td>755</td> <td>790</td> </tr> <tr> <td>655</td> <td>680</td> <td>700</td> <td>725</td> <td>755</td> <td>790</td> <td>825</td> </tr> </tbody> </table>	A/COM	B	C	D	E	F	G	575	600	620	645	675	710	745	620	645	665	690	720	755	790	655	680	700	725	755	790	825	<ul style="list-style-type: none"> • Pneumatic Seat Height Adjustment • Height Adj 20" Diameter Footring • Choice of 6 Mesh Back Colors • Rated for 250 lbs 	WIDTH: 25.0 DEPTH: 26.0 HEIGHT: 36.5-44.5 SEAT WIDTH: 18.0 SEAT DEPTH: 16.0 SEAT HEIGHT: 19.5-27.5 BACK WIDTH: 19.0 BACK HEIGHT: 17.5 COM: 0.8 YDS WEIGHT: 31.5 LB	MESH COLORS <table border="1"> <tr> <td>BLACK M11</td> <td>GRAY M12</td> <td>SILVER M13</td> <td>GREEN M14</td> <td>RED M15</td> <td>BLUE M16</td> </tr> </table>	BLACK M11	GRAY M12	SILVER M13	GREEN M14	RED M15	BLUE M16
A/COM	B	C	D	E	F	G																																			
575	600	620	645	675	710	745																																			
620	645	665	690	720	755	790																																			
655	680	700	725	755	790	825																																			
BLACK M11	GRAY M12	SILVER M13	GREEN M14	RED M15	BLUE M16																																				

*Standard twenty five (25) business days applies only to Metallic Brown, Gunmetal, Dover Gray and White frame color options.

bella

name your game, bella is ready to play

FULLY UPHOLSTERED - UP

GSA SIN # 711-19

- Back styles include: all plastic, upholstered, or mesh back
- Choice of plastic or upholstered seat
- Right hand tablet arm available with optional basket
- 6 powder coated frame finishes
- Warranted up to 250 lbs
- CAL TB 133 Fire Code approved



CREATING BELLA MODEL NUMBER

MODEL NUMBER CONTROL ARMS FRAME COLOR UPHOLSTERY MESH COLOR GRADE CASTERS PACKAGING OPTIONS

1 3 1 - G T - - - - U P - M - - - C 5 - - - -

* FOR ARMLESS CODE USE A00 * ONLY SELECT FOR MODELS 1360/1365 * ONLY SELECT CASTER CODE FOR MODELS 1315/1365

FRAME COLORS

BLACK BF	SILVER SF	METALLIC BROWN* MBF
GUNMETAL* GMF	DOVER GRAY* DGF	WHITE* WF

PACKAGING NOTES

CODE	DESCRIPTION	LIST UPCHARGE
AB	ASSEMBLED IN BAG FOR WILL CALL	\$0
AC	ASSEMBLED IN CARTON	\$0

BELLA STACK CHAIRS SHIP UP TO 3 PER CARTON

NOTE: Due to the nature of vinyl upholstery, stacking may cause impressions on the seat. 9to5 Seating does not warrant the effects of the stacking on vinyl upholstery.

MODEL	CONTROL	DESCRIPTION	ARM	FABRIC	FEATURES	DIMENSIONS	ARM OPTIONS	CASTER OPTIONS																																																																						
1310	GT	GUEST STACKING Upholstered back with upholstered seat.	ARMLESS A12 A14 TAB-A00 TAB-A12 TAB-A14	<table border="1"> <thead> <tr> <th>A/COM</th> <th>B</th> <th>C</th> <th>D</th> <th>E</th> <th>F</th> <th>G</th> </tr> </thead> <tbody> <tr><td>315</td><td>345</td><td>365</td><td>395</td><td>430</td><td>470</td><td>510</td></tr> <tr><td>360</td><td>390</td><td>410</td><td>440</td><td>475</td><td>515</td><td>555</td></tr> <tr><td>395</td><td>425</td><td>445</td><td>475</td><td>510</td><td>550</td><td>590</td></tr> <tr><td>435</td><td>465</td><td>485</td><td>515</td><td>550</td><td>590</td><td>630</td></tr> <tr><td>460</td><td>490</td><td>510</td><td>540</td><td>575</td><td>615</td><td>655</td></tr> <tr><td>475</td><td>505</td><td>525</td><td>555</td><td>590</td><td>630</td><td>670</td></tr> </tbody> </table>	A/COM	B	C	D	E	F	G	315	345	365	395	430	470	510	360	390	410	440	475	515	555	395	425	445	475	510	550	590	435	465	485	515	550	590	630	460	490	510	540	575	615	655	475	505	525	555	590	630	670	<ul style="list-style-type: none"> • Non-Marring Floor Glides • Stack 4 High on Floor • Stacks 10 High on Optional Dolly • Wall Saver Back Legs • Integrated Handle in Back of Chair • Rated for 250 lbs 	<table border="1"> <thead> <tr> <th>ARMLESS</th> <th>W/ ARMS</th> </tr> </thead> <tbody> <tr><td>WIDTH:</td><td>21.0 25.0</td></tr> <tr><td>DEPTH:</td><td>26.0 26.0</td></tr> <tr><td>HEIGHT:</td><td>34.0 34.0</td></tr> <tr><td>SEAT WIDTH:</td><td>18.0 18.0</td></tr> <tr><td>SEAT DEPTH:</td><td>16.0 16.0</td></tr> <tr><td>SEAT HEIGHT:</td><td>18.5 18.5</td></tr> <tr><td>BACK WIDTH:</td><td>19.0 19.0</td></tr> <tr><td>BACK HEIGHT:</td><td>17.5 17.5</td></tr> <tr><td>COM:</td><td>0.9 YDS 0.9 YDS</td></tr> <tr><td>WEIGHT:</td><td>17.0 LB 20.0 LB</td></tr> </tbody> </table>	ARMLESS	W/ ARMS	WIDTH:	21.0 25.0	DEPTH:	26.0 26.0	HEIGHT:	34.0 34.0	SEAT WIDTH:	18.0 18.0	SEAT DEPTH:	16.0 16.0	SEAT HEIGHT:	18.5 18.5	BACK WIDTH:	19.0 19.0	BACK HEIGHT:	17.5 17.5	COM:	0.9 YDS 0.9 YDS	WEIGHT:	17.0 LB 20.0 LB	
A/COM	B	C	D	E	F	G																																																																								
315	345	365	395	430	470	510																																																																								
360	390	410	440	475	515	555																																																																								
395	425	445	475	510	550	590																																																																								
435	465	485	515	550	590	630																																																																								
460	490	510	540	575	615	655																																																																								
475	505	525	555	590	630	670																																																																								
ARMLESS	W/ ARMS																																																																													
WIDTH:	21.0 25.0																																																																													
DEPTH:	26.0 26.0																																																																													
HEIGHT:	34.0 34.0																																																																													
SEAT WIDTH:	18.0 18.0																																																																													
SEAT DEPTH:	16.0 16.0																																																																													
SEAT HEIGHT:	18.5 18.5																																																																													
BACK WIDTH:	19.0 19.0																																																																													
BACK HEIGHT:	17.5 17.5																																																																													
COM:	0.9 YDS 0.9 YDS																																																																													
WEIGHT:	17.0 LB 20.0 LB																																																																													
1315	GT	GUEST STACKING WITH CASTERS Upholstered back with upholstered seat.	ARMLESS A12 A14 TAB-A00 TAB-A12 TAB-A14	<table border="1"> <thead> <tr> <th>A/COM</th> <th>B</th> <th>C</th> <th>D</th> <th>E</th> <th>F</th> <th>G</th> </tr> </thead> <tbody> <tr><td>360</td><td>390</td><td>410</td><td>440</td><td>475</td><td>515</td><td>555</td></tr> <tr><td>405</td><td>435</td><td>455</td><td>485</td><td>520</td><td>560</td><td>600</td></tr> <tr><td>440</td><td>470</td><td>490</td><td>520</td><td>555</td><td>595</td><td>635</td></tr> <tr><td>480</td><td>510</td><td>530</td><td>560</td><td>595</td><td>635</td><td>675</td></tr> <tr><td>505</td><td>535</td><td>555</td><td>585</td><td>620</td><td>660</td><td>700</td></tr> <tr><td>520</td><td>550</td><td>570</td><td>600</td><td>635</td><td>675</td><td>715</td></tr> </tbody> </table>	A/COM	B	C	D	E	F	G	360	390	410	440	475	515	555	405	435	455	485	520	560	600	440	470	490	520	555	595	635	480	510	530	560	595	635	675	505	535	555	585	620	660	700	520	550	570	600	635	675	715	<ul style="list-style-type: none"> • 50mm Hooded Casters • Stack 4 High on Floor • Stacks 10 High on Optional Dolly • Integrated Handle in Back of Chair • Rated for 250 lbs 	<table border="1"> <thead> <tr> <th>ARMLESS</th> <th>W/ ARMS</th> </tr> </thead> <tbody> <tr><td>WIDTH:</td><td>21.0 25.0</td></tr> <tr><td>DEPTH:</td><td>26.0 26.0</td></tr> <tr><td>HEIGHT:</td><td>34.0 34.0</td></tr> <tr><td>SEAT WIDTH:</td><td>18.0 18.0</td></tr> <tr><td>SEAT DEPTH:</td><td>16.0 16.0</td></tr> <tr><td>SEAT HEIGHT:</td><td>18.5 18.5</td></tr> <tr><td>BACK WIDTH:</td><td>19.0 19.0</td></tr> <tr><td>BACK HEIGHT:</td><td>17.5 17.5</td></tr> <tr><td>COM:</td><td>0.9 YDS 0.9 YDS</td></tr> <tr><td>WEIGHT:</td><td>17.0 LB 20.0 LB</td></tr> </tbody> </table>	ARMLESS	W/ ARMS	WIDTH:	21.0 25.0	DEPTH:	26.0 26.0	HEIGHT:	34.0 34.0	SEAT WIDTH:	18.0 18.0	SEAT DEPTH:	16.0 16.0	SEAT HEIGHT:	18.5 18.5	BACK WIDTH:	19.0 19.0	BACK HEIGHT:	17.5 17.5	COM:	0.9 YDS 0.9 YDS	WEIGHT:	17.0 LB 20.0 LB	
A/COM	B	C	D	E	F	G																																																																								
360	390	410	440	475	515	555																																																																								
405	435	455	485	520	560	600																																																																								
440	470	490	520	555	595	635																																																																								
480	510	530	560	595	635	675																																																																								
505	535	555	585	620	660	700																																																																								
520	550	570	600	635	675	715																																																																								
ARMLESS	W/ ARMS																																																																													
WIDTH:	21.0 25.0																																																																													
DEPTH:	26.0 26.0																																																																													
HEIGHT:	34.0 34.0																																																																													
SEAT WIDTH:	18.0 18.0																																																																													
SEAT DEPTH:	16.0 16.0																																																																													
SEAT HEIGHT:	18.5 18.5																																																																													
BACK WIDTH:	19.0 19.0																																																																													
BACK HEIGHT:	17.5 17.5																																																																													
COM:	0.9 YDS 0.9 YDS																																																																													
WEIGHT:	17.0 LB 20.0 LB																																																																													
							<p>Side Hanging Wire Basket for model 1310, 1315, 1360, 1365. Attach to left or right side.</p>	<p>Stacking Dolly Stack Chair 10 High</p> <p>Ganging Clip - 2 per set GC1 - Armless-to-Armless GC2 - Arm-to-Arm</p>																																																																						

CAUTION: Careless stacking of chairs may scratch and damage frames.

*Standard twenty five (25) business days applies only to Metallic Brown, Gunmetal, Dover Gray and White frame color options.

bella

name your game, bella is ready to play

FULLY UPHOLSTERED - UP

GSA SIN # 711-18

- Back styles include: all plastic, upholstered, or mesh back
- Choice of plastic or upholstered seat
- 6 powder coated frame finishes
- Seat flips up for nesting
- Warranted up to 250 lbs
- CAL TB 133 Fire Code approved



CREATING BELLA MODEL NUMBER

MODEL NUMBER CONTROL ARMS FRAME COLOR UPHOLSTERY GRADE CASTERS PACKAGING OPTIONS

1 3 2 0 - G T - A [] [] - [] [] - U P - [] - C 5 [] [] - [] [] [] []

* FOR ARMLESS CODE USE ADD

FRAME COLORS

BLACK BF	SILVER SF	METALLIC BROWN* MBF
GUNMETAL* GMF	DOVER GRAY* DGF	WHITE* WF

PACKAGING NOTES

CODE	DESCRIPTION	LIST UPCHARGE
AB	ASSEMBLED IN BAG FOR WILL CALL	\$0
AC	ASSEMBLED IN CARTON	\$0

BELLA NESTING CHAIRS SHIP UP TO 2 PER CARTON

MODEL	CONTROL	DESCRIPTION	ARM	FABRIC	FEATURES	DIMENSIONS	ARM OPTIONS	CASTER OPTIONS																																																		
1320	GT	GUEST NESTING Upholstered back with upholstered seat.	ARMLESS A12 A14	<table border="1"> <thead> <tr> <th>A/COM</th> <th>B</th> <th>C</th> <th>D</th> <th>E</th> <th>F</th> <th>G</th> </tr> </thead> <tbody> <tr> <td>380</td> <td>410</td> <td>430</td> <td>460</td> <td>495</td> <td>535</td> <td>575</td> </tr> <tr> <td>425</td> <td>455</td> <td>475</td> <td>505</td> <td>540</td> <td>580</td> <td>620</td> </tr> <tr> <td>460</td> <td>490</td> <td>510</td> <td>540</td> <td>575</td> <td>615</td> <td>655</td> </tr> </tbody> </table>	A/COM	B	C	D	E	F	G	380	410	430	460	495	535	575	425	455	475	505	540	580	620	460	490	510	540	575	615	655	<ul style="list-style-type: none"> • Flip Up Seat for Nesting and Compact Storage • 50mm Hooded Casters • Integrated Handle in Back of Chair • Rated for 250 lbs 	<table border="1"> <thead> <tr> <th>ARMLESS</th> <th>W/ ARMS</th> </tr> </thead> <tbody> <tr> <td>WIDTH: 21.0</td> <td>25.0</td> </tr> <tr> <td>DEPTH: 26.0</td> <td>26.0</td> </tr> <tr> <td>HEIGHT: 34.0</td> <td>34.0</td> </tr> <tr> <td>SEAT WIDTH: 18.0</td> <td>18.0</td> </tr> <tr> <td>SEAT DEPTH: 16.0</td> <td>16.0</td> </tr> <tr> <td>SEAT HEIGHT: 18.5</td> <td>18.5</td> </tr> <tr> <td>BACK WIDTH: 19.0</td> <td>19.0</td> </tr> <tr> <td>BACK HEIGHT: 17.5</td> <td>17.5</td> </tr> <tr> <td>COM: 0.9 YDS</td> <td>0.9 YDS</td> </tr> <tr> <td>WEIGHT: 24.0 LB</td> <td>27.0 LB</td> </tr> </tbody> </table>	ARMLESS	W/ ARMS	WIDTH: 21.0	25.0	DEPTH: 26.0	26.0	HEIGHT: 34.0	34.0	SEAT WIDTH: 18.0	18.0	SEAT DEPTH: 16.0	16.0	SEAT HEIGHT: 18.5	18.5	BACK WIDTH: 19.0	19.0	BACK HEIGHT: 17.5	17.5	COM: 0.9 YDS	0.9 YDS	WEIGHT: 24.0 LB	27.0 LB	<p>A12 \$45 Fixed Arm</p> <p>A14 \$80 Reinforced Soft Touch Extended Arm</p>	<p>C5 STD Standard 50mm Hooded Casters</p> <p>C5S \$30 50mm Hooded Hard Floor Casters</p>
A/COM	B	C	D	E	F	G																																																				
380	410	430	460	495	535	575																																																				
425	455	475	505	540	580	620																																																				
460	490	510	540	575	615	655																																																				
ARMLESS	W/ ARMS																																																									
WIDTH: 21.0	25.0																																																									
DEPTH: 26.0	26.0																																																									
HEIGHT: 34.0	34.0																																																									
SEAT WIDTH: 18.0	18.0																																																									
SEAT DEPTH: 16.0	16.0																																																									
SEAT HEIGHT: 18.5	18.5																																																									
BACK WIDTH: 19.0	19.0																																																									
BACK HEIGHT: 17.5	17.5																																																									
COM: 0.9 YDS	0.9 YDS																																																									
WEIGHT: 24.0 LB	27.0 LB																																																									
							<p>NESTING FOOTPRINT</p> <p>First Chair 24", Each Additional Chair, Add 6"</p>	<p>ACCESSORIES</p>																																																		

CAUTION: Careless nesting of chairs may scratch and damage frames.

*Standard twenty five (25) business days applies only to Metallic Brown, Gunmetal, Dover Gray and White frame color options.

bella

name your game, bella is ready to play

FULLY UPHOLSTERED - UP

GSA SIN # 711-18

- Training, task, multipurpose, stool, management and conference seating
- Back styles include: all plastic, upholstered, or mesh back
- Choice of plastic or upholstered seat
- 6 powder coated frame finishes
- Warranted up to 250 lbs
- CAL TB 133 Fire Code approved



CREATING BELLA MODEL NUMBER

MODEL NUMBER CONTROL ARMS FRAME COLOR UPHOLSTERY MESH COLOR GRADE CASTERS PACKAGING OPTIONS

1 3 2 5 - [] [] - A [] [] - [] [] - U P - M [] [] - [] [] - C 6 [] [] - [] [] [] []

* FOR ARMLESS CODE USE A00 * ONLY SELECT FOR MODELS 1375 * ONLY SELECT CASTER CODE FOR MODELS 1315/1365

FRAME COLORS

BLACK BF	SILVER SF	METALLIC BROWN* MBF
GUNMETAL* GMF	DOVER GRAY* DGF	WHITE* WF

PACKAGING NOTES

CODE	DESCRIPTION	LIST UPCHARGE
AB	ASSEMBLED IN BAG FOR WILL CALL	\$0
BAC	ASSEMBLED IN CARTON	\$0

MODEL	CONTROL	DESCRIPTION	ARM	FABRIC	FEATURES	DIMENSIONS	ARM OPTIONS	CASTER OPTIONS																											
1325	B2	LOW-BACK BASIC CONTROL Upholstered back with upholstered seat.	ARMLESS A12 A14	<table border="1"> <thead> <tr> <th>A/COM</th> <th>B</th> <th>C</th> <th>D</th> <th>E</th> <th>F</th> <th>G</th> </tr> </thead> <tbody> <tr> <td>440</td> <td>470</td> <td>490</td> <td>520</td> <td>555</td> <td>595</td> <td>635</td> </tr> <tr> <td>485</td> <td>515</td> <td>535</td> <td>565</td> <td>600</td> <td>640</td> <td>680</td> </tr> <tr> <td>520</td> <td>550</td> <td>570</td> <td>600</td> <td>635</td> <td>675</td> <td>715</td> </tr> </tbody> </table>	A/COM	B	C	D	E	F	G	440	470	490	520	555	595	635	485	515	535	565	600	640	680	520	550	570	600	635	675	715	<ul style="list-style-type: none"> • Pneumatic Seat Height Adjustment • Basic Control Swivels 360 Degrees • Rated for 250 lbs 	<p>WIDTH: 25.0 DEPTH: 26.0 HEIGHT: 34.0-38.5 SEAT WIDTH: 18.0 SEAT DEPTH: 16.0 SEAT HEIGHT: 18.5-23.0 BACK WIDTH: 19.0 BACK HEIGHT: 17.5 COM: 0.9 YDS WEIGHT: 30.0 LB</p>	<p>A12 \$45 Fixed Arm</p> <p>A14 \$80 Reinforced Soft Touch Extended Arm</p> <p>C6 STD Standard 60mm Hoodless Casters</p> <p>C6S \$30 60mm Hoodless Hard Floor Casters</p>
A/COM	B	C	D	E	F	G																													
440	470	490	520	555	595	635																													
485	515	535	565	600	640	680																													
520	550	570	600	635	675	715																													
1325	S3	LOW-BACK SWIVEL TILT CONTROL Upholstered back with upholstered seat.	ARMLESS A12 A14	<table border="1"> <thead> <tr> <th>A/COM</th> <th>B</th> <th>C</th> <th>D</th> <th>E</th> <th>F</th> <th>G</th> </tr> </thead> <tbody> <tr> <td>475</td> <td>505</td> <td>525</td> <td>555</td> <td>590</td> <td>630</td> <td>670</td> </tr> <tr> <td>520</td> <td>550</td> <td>570</td> <td>600</td> <td>635</td> <td>675</td> <td>715</td> </tr> <tr> <td>555</td> <td>585</td> <td>605</td> <td>635</td> <td>670</td> <td>710</td> <td>750</td> </tr> </tbody> </table>	A/COM	B	C	D	E	F	G	475	505	525	555	590	630	670	520	550	570	600	635	675	715	555	585	605	635	670	710	750	<ul style="list-style-type: none"> • Pneumatic Seat Height Adjustment • Tilt Tension Control • Seat and Back Tilt as a Unit • Upright Position Tilt Lock • Rated for 250 lbs 	<p>WIDTH: 25.0 DEPTH: 26.0 HEIGHT: 34.0-38.5 SEAT WIDTH: 18.0 SEAT DEPTH: 16.0 SEAT HEIGHT: 17.0-21.5 BACK WIDTH: 19.0 BACK HEIGHT: 17.5 COM: 0.9 YDS WEIGHT: 31.0 LB</p>	<p>BA10B BA10P BA10S \$100</p> <p>26" High Profile Aluminum Base BA10B - Black Powder-Coat BA10P - Polished BA10S - Silver Powder-Coat</p>
A/COM	B	C	D	E	F	G																													
475	505	525	555	590	630	670																													
520	550	570	600	635	675	715																													
555	585	605	635	670	710	750																													

*Standard twenty five (25) business days applies only to Metallic Brown, Gunmetal, Dover Gray and White frame color options.

bella

name your game, bella is ready to play

FULLY UPHOLSTERED - UP

GSA SIN # 711-18

- Training, task, multipurpose, stool, management and conference seating
- Back styles include: all plastic, upholstered, or mesh back
- Choice of plastic or upholstered seat
- 6 powder coated frame finishes
- Warranted up to 250 lbs
- CAL TB 133 Fire Code approved



CREATING BELLA MODEL NUMBER

MODEL NUMBER CONTROL ARMS FRAME COLOR UPHOLSTERY MESH COLOR GRADE CASTERS PACKAGING OPTIONS

1 3 2 - B 2 - A - - - U P - M - - - C 6 - - - - -



* FOR ARMLESS CODE USE A00 * ONLY SELECT FOR MODELS 1360/1365

FRAME COLORS

BLACK BF	SILVER SF	METALLIC BROWN* MBF
GUNMETAL* GMF	DOVER GRAY* DGF	WHITE* WF

PACKAGING NOTES

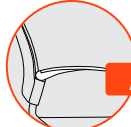
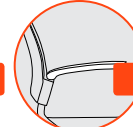
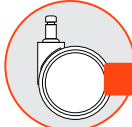
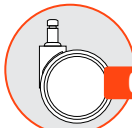
CODE	DESCRIPTION	LIST UPCHARGE
AB	ASSEMBLED IN BAG FOR WILL CALL	\$0
BAC	ASSEMBLED IN CARTON	\$0

MODEL	CONTROL	DESCRIPTION	ARM	FABRIC	FEATURES	DIMENSIONS	ARM OPTIONS	CASTER OPTIONS																												
1326	B2	10" TRAVEL HIGH STOOL BASIC CONTROL Use for work surfaces up to 42 inches high. Upholstered back with upholstered seat.	ARMLESS A12 A14	<table border="1"> <thead> <tr> <th>A/COM</th> <th>B</th> <th>C</th> <th>D</th> <th>E</th> <th>F</th> <th>G</th> </tr> </thead> <tbody> <tr> <td>565</td> <td>595</td> <td>615</td> <td>645</td> <td>680</td> <td>720</td> <td>760</td> </tr> <tr> <td>610</td> <td>640</td> <td>660</td> <td>690</td> <td>725</td> <td>765</td> <td>805</td> </tr> <tr> <td>645</td> <td>675</td> <td>695</td> <td>725</td> <td>760</td> <td>800</td> <td>840</td> </tr> </tbody> </table>	A/COM	B	C	D	E	F	G	565	595	615	645	680	720	760	610	640	660	690	725	765	805	645	675	695	725	760	800	840	<ul style="list-style-type: none"> • Pneumatic Seat Height Adjustment • Height Adj 20" Diameter Footring • Rated for 250 lbs 	WIDTH: 25.0 DEPTH: 26.0 HEIGHT: 40.5-50.5 SEAT WIDTH: 18.0 SEAT DEPTH: 16.0 SEAT HEIGHT: 23.5-33.5 BACK WIDTH: 19.0 BACK HEIGHT: 17.5 COM: 0.9 YDS WEIGHT: 36.0 LB	 A12 \$45  A14 \$80	 C6 STD  C6S \$35
A/COM	B	C	D	E	F	G																														
565	595	615	645	680	720	760																														
610	640	660	690	725	765	805																														
645	675	695	725	760	800	840																														
1328	B2	8" TRAVEL LOW STOOL BASIC CONTROL Use for work surfaces up to 36 inches high. Upholstered back with upholstered seat.	ARMLESS A12 A14	<table border="1"> <thead> <tr> <th>A/COM</th> <th>B</th> <th>C</th> <th>D</th> <th>E</th> <th>F</th> <th>G</th> </tr> </thead> <tbody> <tr> <td>565</td> <td>595</td> <td>615</td> <td>645</td> <td>680</td> <td>720</td> <td>760</td> </tr> <tr> <td>610</td> <td>640</td> <td>660</td> <td>690</td> <td>725</td> <td>765</td> <td>805</td> </tr> <tr> <td>645</td> <td>675</td> <td>695</td> <td>725</td> <td>760</td> <td>800</td> <td>840</td> </tr> </tbody> </table>	A/COM	B	C	D	E	F	G	565	595	615	645	680	720	760	610	640	660	690	725	765	805	645	675	695	725	760	800	840	<ul style="list-style-type: none"> • Pneumatic Seat Height Adjustment • Height Adj 20" Diameter Footring • Rated for 250 lbs 	WIDTH: 25.0 DEPTH: 26.0 HEIGHT: 36.5-44.5 SEAT WIDTH: 18.0 SEAT DEPTH: 16.0 SEAT HEIGHT: 19.5-27.5 BACK WIDTH: 19.0 BACK HEIGHT: 17.5 COM: 0.9 YDS WEIGHT: 35.0 LB	 BA10B BA10P BA10S \$100 26" High Profile Aluminum Base BA10B - Black Powder-Coat BA10P - Polished BA10S - Silver Powder-Coat	
A/COM	B	C	D	E	F	G																														
565	595	615	645	680	720	760																														
610	640	660	690	725	765	805																														
645	675	695	725	760	800	840																														

*Standard twenty five (25) business days applies only to Metallic Brown, Gunmetal, Dover Gray and White frame color options.

brío

mesh back chairs tailored to you

MESH BACK

GSA SIN # 711-18

- Task, stool, management and conference seating
- Mesh back
- Rolling flex back follows user's shoulder movements
- Reverse seat slider for more petite seat, standard on all models
- Optional height adjustable lumbar
- Warranted up to 250 lbs



CREATING BRIO MODEL NUMBER

MODEL NUMBER CONTROL ARMS BACK MESH COLOR GRADE CASTERS PACKAGING OPTIONS

2 0 6 0 - [] [] - A [] [] - M 0 1 - [] - C 6 [] [] - [] [] [] []

* FOR ARMLESS CODE USE A00

PACKAGING NOTES

CODE	DESCRIPTION	LIST UPCHARGE
AB	ASSEMBLED IN BAG FOR WILL CALL	\$0
BAC	BACK ASSEMBLED IN CARTON	\$0

MODEL CONTROL DESCRIPTION

ARM FABRIC

FEATURES

DIMENSIONS

ARM OPTIONS

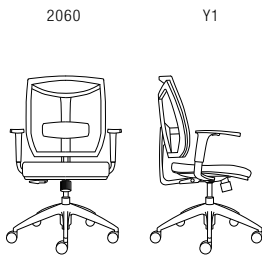

MID-BACK SIMPLE SYNCHRO TILT CONTROL

Use for a variety of general office task seating, including private office and conference room seating.

ARM	FABRIC	T01	A/COM	B	C	D	E	F	G
ARMLESS		440	490	515	535	560	590	625	660
A2		520	570	595	615	640	670	705	740
A8B / A8S		525	575	600	620	645	675	710	745
A9B / A9S		545	595	620	640	665	695	730	765
A10		525	575	600	620	645	675	710	745
A36		545	595	620	640	665	695	730	765
A37		565	615	640	660	685	715	750	785

- Pneumatic Seat Height Adjustment
- Tilt Tension Control
- Back and Seat Tilt in 3:1 Ratio
- Upright Position Tilt Lock
- Molded Foam Seat
- Optional Height Adjustable Lumbar
- Rated for 250 lbs

WIDTH: 25.0
 DEPTH: 26.0
 HEIGHT: 39.0-43.5
 SEAT WIDTH: 20.0
 SEAT DEPTH: 14.5-17.0
 SEAT HEIGHT: 17.0-21.5
 BACK WIDTH: 18.0
 BACK HEIGHT: 22.0
 COM: 0.8 YDS
 WEIGHT: 36.5 LB

A2
\$80

2-Way Adjustable Arm Height Adjustable (for use with Y1, Y3, M1 and P1 controls)

A8B/S
\$85
A9B/S
\$105

A8 2-Way Height Adjustable Arm, A9 4-Way Adjustable Height Adjustable with 4" Interior Width Adjustment
A8B -Black, A8S -Silver
A9B -Black, A9S -Silver

A10
\$85

Black Soft Touch Cantilever style C-Shaped Arm

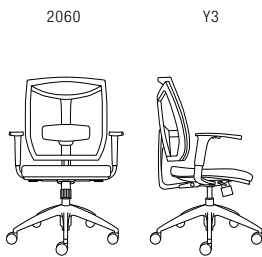

MID-BACK FULL SYNCHRO TILT CONTROL

Use for a variety of general office task seating, including private office and conference room seating.

ARM	FABRIC	T01	A/COM	B	C	D	E	F	G
ARMLESS		510	560	585	605	630	660	695	730
A2		590	640	665	685	710	740	775	810
A8B / A8S		595	645	670	690	715	745	780	815
A9B / A9S		615	665	690	710	735	765	800	835
A10		595	645	670	690	715	745	780	815
A36		615	665	690	710	725	765	800	835
A37		635	685	710	730	755	785	820	855

- Pneumatic Seat Height Adjustment
- Tilt Tension Control
- Back and Seat Tilt in 2:1 ratio
- 3 Locking Positions
- Safety Tilt Release
- Molded Foam Seat
- Optional Height Adjustable Lumbar
- Rated for 250 lbs

WIDTH: 25.0
 DEPTH: 26.0
 HEIGHT: 39.0-43.5
 SEAT WIDTH: 20.0
 SEAT DEPTH: 15.5-18.0
 SEAT HEIGHT: 16.5-21.0
 BACK WIDTH: 18.0
 BACK HEIGHT: 22.0
 COM: 0.8 YDS
 WEIGHT: 38.0 LB

A36
\$105

8-Way Adjustable Arms Soft-Touch sliding and pivoting arm pads.

A37
\$125

10-Way Adjustable Arms Soft-Touch sliding and pivoting arm pads and 4" arm width knob under seat.

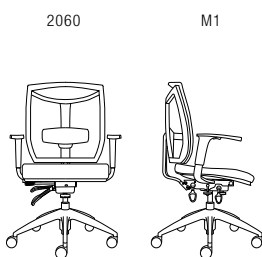

MID-BACK MULTIFUNCTION CONTROL

Fully articulating seat and back for the highest level of ergonomic needs. Control allows user to pivot seat forward from 0° to 6°.

ARM	FABRIC	T01	A/COM	B	C	D	E	F	G
ARMLESS		540	590	615	635	660	690	725	760
A2		620	670	695	715	740	770	805	840
A8B / A8S		625	675	700	720	745	775	810	845
A9B / A9S		645	695	720	740	765	795	830	865
A10		625	675	700	720	745	775	810	845
A36		645	695	720	740	765	795	830	865
A37		665	715	740	760	785	815	850	885

- Pneumatic Seat Height Adjustment
- Tilt Tension Control
- Seat and Back Tilt as a Unit
- Floating seat position tilt lock
- Infinite Back Angle Adj w/ Free Float
- Seat Pivots from 0° to 6° Forward
- Molded Foam Seat
- Optional Height Adjustable Lumbar
- Rated for 250 lbs

WIDTH: 25.0
 DEPTH: 26.0
 HEIGHT: 39.0-43.5
 SEAT WIDTH: 20.0
 SEAT DEPTH: 14.5-17.0
 SEAT HEIGHT: 17.0-21.5
 BACK WIDTH: 18.0
 BACK HEIGHT: 22.0
 COM: 0.8 YDS
 WEIGHT: 44.0 LB

CASTER OPTIONS

C6
STD

Standard 60mm Hoodless Casters

C6S
\$35

60mm Hoodless Hard Floor Casters

ADDITIONAL OPTIONS

LB
\$30

Height Adjustable Lumbar Support

BA10B
BA10P
BA10S
\$100

26" High Profile Aluminum Base
BA10B - Black Powder-Coat
BA10P - Polished
BA10S - Silver Powder-Coat

brío

mesh back chairs tailored to you

STOOL

GSA SIN # 711-18

- Task, stool, management and conference seating
- Mesh back
- Rolling flex back follows user's shoulder movements
- Reverse seat slider for more petite seat, standard on all models
- Optional height adjustable lumbar
- Warranted up to 250 lbs



CREATING BRIO MODEL NUMBER

MODEL NUMBER	CONTROL	ARMS	BACK MESH COLOR	GRADE	CASTERS	PACKAGING	OPTIONS
206		A	M	O	1	C	6

* FOR ARMLESS CODE USE A00

PACKAGING NOTES

CODE	DESCRIPTION	LIST UPCHARGE
AB	ASSEMBLED IN BAG FOR WILL CALL	\$0
BAC	BACK ASSEMBLED IN CARTON	\$0

MODEL	CONTROL	DESCRIPTION	ARM	FABRIC	FEATURES	DIMENSIONS	ARM OPTIONS
2066	Y1	10" TRAVEL HIGH STOOL SIMPLE SYNCHRO TILT CONTROL Use for work surfaces up to 42 inches high.	ARMLESS	T01 565, A/COM 615, B 640, C 660, D 685, E 715, F 750, G 785	<ul style="list-style-type: none"> • Pneumatic Seat Height Adjustment • Tilt Tension Control • Back and Seat Tilt in 3:1 Ratio • Upright Position Tilt Lock • Molded Foam Seat • Optional Height Adjustable Lumbar • Height Adj 20" Diameter Footring • Rated for 250 lbs 	WIDTH: 25.0 DEPTH: 26.0 HEIGHT: 48.5-58.5 SEAT WIDTH: 20.0 SEAT DEPTH: 14.5-17.0 SEAT HEIGHT: 26.6-36.5 BACK WIDTH: 18.0 BACK HEIGHT: 22.0 COM: 0.8 YDS WEIGHT: 43.5 LB	A2 \$80 2-Way Adjustable Arm Height Adjustable (for use with Y1, Y3, M1 and P1 controls)
			A2	645, 695, 720, 740, 765, 795, 830, 865			
2066	P1	10" TRAVEL HIGH STOOL POSTURE BACK CONTROL Use for work surfaces up to 42 inches high.	ARMLESS	T01 600, A/COM 650, B 675, C 695, D 720, E 750, F 785, G 820	<ul style="list-style-type: none"> • Pneumatic Seat Height Adjustment • Infinite Back Angle with Free Float • Optional Height Adjustable Lumbar • Height Adj 20" Diameter Footring • Rated for 250 lbs 	WIDTH: 25.0 DEPTH: 26.0 HEIGHT: 48.5-58.5 SEAT WIDTH: 20.0 SEAT DEPTH: 14.5-17.0 SEAT HEIGHT: 26.5-36.5 BACK WIDTH: 18.0 BACK HEIGHT: 22.0 COM: 0.8 YDS WEIGHT: 45.5 LB	A36 \$105 8-Way Adjustable Arms Soft-Touch sliding and pivoting arm pads.
			A2	680, 730, 755, 775, 800, 830, 865, 900			
2068	Y1	8" TRAVEL LOW STOOL SIMPLE SYNCHRO TILT CONTROL Use for work surfaces up to 36 inches high.	ARMLESS	T01 565, A/COM 615, B 640, C 660, D 685, E 715, F 750, G 785	<ul style="list-style-type: none"> • Pneumatic Seat Height Adjustment • Tilt Tension Control • Back and Seat Tilt in 3:1 Ratio • Upright Position Tilt Lock • Molded Foam Seat • Optional Height Adjustable Lumbar • Height Adj 20" Diameter Footring • Rated for 250 lbs 	WIDTH: 25.0 DEPTH: 26.0 HEIGHT: 44.5-52.5 SEAT WIDTH: 20.0 SEAT DEPTH: 14.5-17.0 SEAT HEIGHT: 22.5-30.5 BACK WIDTH: 18.0 BACK HEIGHT: 22.0 COM: 0.8 YDS WEIGHT: 42.8 LB	C6 STD Standard 60mm Hoodless Casters
			A2	645, 695, 720, 740, 765, 795, 830, 865			
2068	P1	8" TRAVEL LOW STOOL POSTURE BACK CONTROL Use for work surfaces up to 36 inches high.	ARMLESS	T01 600, A/COM 650, B 675, C 695, D 720, E 750, F 785, G 820	<ul style="list-style-type: none"> • Pneumatic Seat Height Adjustment • Infinite Back Angle with Free Float • Optional Height Adjustable Lumbar • Height Adj 20" Diameter Footring • Rated for 250 lbs 	WIDTH: 25.0 DEPTH: 26.0 HEIGHT: 44.5-52.5 SEAT WIDTH: 20.0 SEAT DEPTH: 14.5-17.0 SEAT HEIGHT: 22.5-30.5 BACK WIDTH: 18.0 BACK HEIGHT: 22.0 COM: 0.8 YDS WEIGHT: 44.8 LB	LB \$30 Height Adjustable Lumbar Support
			A2	680, 730, 755, 775, 800, 830, 865, 900			

bristol

seamless integration into your office's architecture

MID-BACK

GSA SIN # 711-18

- Management, task, stool, and conference seating
- Ratchet back height adjustment on all models
- Warranted up to 250 lbs with S2, R1, P1
- Warranted up to 300 lbs with M1, Y2
- CAL TB 133 Fire Code approved



CREATING BRISTOL MODEL NUMBER

MODEL NUMBER CONTROL ARMS GRADE CASTERS PACKAGING OPTIONS

2 3 6 0 - - A - - C 6 - - - -

* FOR ARMLESS CODE USE A00 * GT MODELS DO NOT HAVE A CASTER CODE

PACKAGING NOTES

CODE	DESCRIPTION	LIST UPCHARGE
AB	ASSEMBLED IN BAG FOR WILL CALL	\$0
PAC	PARTIALLY ASSEMBLED IN CARTON	\$0
BAC	BACK ASSEMBLED IN CARTON	\$40

MODEL CONTROL DESCRIPTION

ARM FABRIC/LEATHER

FEATURES

DIMENSIONS

ARM OPTIONS



MID-BACK SWIVEL TILT CONTROL

Use for a variety of general office task seating, including private office and conference room seating.

ARM	A/COM	B	C	D	E	F	G	L3/COL	L4	L5
ARMLESS	505	550	580	625	675	735	800	665	740	900
A8B / A8S	590	635	665	710	760	820	885	750	825	985
A9B / A9S	610	655	685	730	780	840	905	770	845	1005
A10	590	635	665	710	760	820	885	750	825	985
A19	705	750	780	825	875	935	1000	865	940	1100
A36	610	655	685	730	780	840	905	770	845	1005
A37	630	675	705	750	800	860	925	790	865	1025

SEAT SLIDER (SS) - ADD \$60

- Pneumatic Seat Height Adjustment
- Tilt Tension Control
- Seat and Back Tilt as a Unit
- Upright Position Tilt Lock
- Ratchet Back Height Lumbar Adjustment
- Rated for 250 lbs

WIDTH: 25.0
 DEPTH: 26.0
 HEIGHT: 39.0-46.0
 SEAT WIDTH: 20.0
 SEAT DEPTH: 19.0
 SEAT HEIGHT: 17.0-21.5
 BACK WIDTH: 20.0
 BACK HEIGHT: 19.0-21.5
 COM: 1.4 YDS
 COL: 20.0 SQ FT
 WEIGHT: 30.0 LB

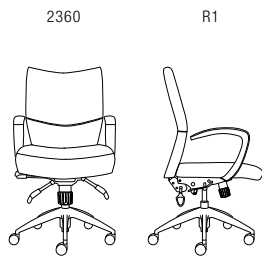

MID-BACK ROCKING CONTROL

For managerial and task applications. Similar to a swivel tilt control, with the added comfort of infinite back angle and tilt adjustment.

ARM	A/COM	B	C	D	E	F	G	L3/COL	L4	L5
ARMLESS	555	600	630	675	725	785	850	715	790	950
A8B / A8S	640	685	715	760	810	870	935	800	875	1035
A9B / A9S	660	705	735	780	830	890	955	820	895	1055
A10	640	685	715	760	810	870	935	800	875	1035
A19	755	800	830	875	925	985	1050	915	990	1150
A36	660	705	735	780	830	890	955	820	895	1055
A37	680	725	755	800	850	910	975	840	915	1075

SEAT SLIDER (SS) - ADD \$60

- Pneumatic Seat Height Adjustment
- Tilt Tension Control
- Seat and Back Tilt as a Unit
- Floating Seat Position Tilt Lock
- Infinite Back Angle Adj w/ Free Float
- Ratchet Back Height Lumbar Adjustment
- Rated for 250 lbs

WIDTH: 25.0
 DEPTH: 26.0
 HEIGHT: 39.0-46.0
 SEAT WIDTH: 20.0
 SEAT DEPTH: 19.0
 SEAT HEIGHT: 18.0-22.5
 BACK WIDTH: 20.0
 BACK HEIGHT: 19.0-21.5
 COM: 1.4 YDS
 COL: 20.0 SQ FT
 WEIGHT: 35.0 LB

CASTER OPTIONS

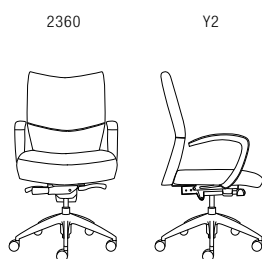

MID-BACK HEAVY DUTY SYNCHRO TILT CONTROL

Use for a variety of general office task seating, including private office and conference room seating.

ARM	A/COM	B	C	D	E	F	G	L3/COL	L4	L5
ARMLESS	585	630	660	705	755	815	880	745	820	980
A8B / A8S	670	715	745	790	840	900	965	830	905	1065
A9B / A9S	690	735	765	810	860	920	985	850	925	1085
A10	670	715	745	790	840	900	965	830	905	1065
A19	785	830	860	905	955	1015	1080	945	1020	1180
A36	690	735	765	810	860	920	985	850	925	1085
A37	710	755	785	830	880	940	1005	870	945	1105

SEAT SLIDER (SS) - ADD \$60

- Pneumatic Seat Height Adjustment
- Side Tilt Tension Control
- Back and Seat Tilt in 2:1 ratio
- 4 Locking Positions
- Safety Tilt Release
- Ratchet Back Height Lumbar Adjustment
- Rated for 300 lbs

WIDTH: 25.0
 DEPTH: 26.0
 HEIGHT: 39.0-46.0
 SEAT WIDTH: 20.0
 SEAT DEPTH: 19.0
 SEAT HEIGHT: 18.0-22.5
 BACK WIDTH: 20.0
 BACK HEIGHT: 19.0-21.5
 COM: 1.4 YDS
 COL: 20.0 SQ FT
 WEIGHT: 39.0 LB

ADDITIONAL OPTIONS

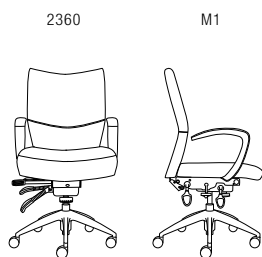

MID-BACK MULTIFUNCTION CONTROL

Fully articulating seat and back for the highest level of ergonomic needs. Control allows user to pivot seat forward from 0° to 6°.

ARM	A/COM	B	C	D	E	F	G	L3/COL	L4	L5
ARMLESS	605	650	680	725	775	835	900	765	840	1000
A8B / A8S	690	735	765	810	860	920	985	850	925	1085
A9B / A9S	710	755	785	830	880	940	1005	870	945	1105
A10	690	735	765	810	860	920	985	850	925	1085
A19	805	850	880	925	975	1035	1100	965	1040	1200
A36	710	755	785	830	880	940	1005	870	945	1105
A37	730	775	805	850	900	960	1025	890	965	1125

SEAT SLIDER (SS) - ADD \$60

- Pneumatic Seat Height Adjustment
- Tilt Tension Control
- Seat and Back Tilt as a Unit
- Floating Seat Position Tilt Lock
- Infinite Back Angle Adj w/ Free Float
- Seat Pivots from 0° to 6° Forward
- Ratchet Back Height Lumbar Adjustment
- Rated for 300 lbs

WIDTH: 25.0
 DEPTH: 26.0
 HEIGHT: 39.0-46.0
 SEAT WIDTH: 20.0
 SEAT DEPTH: 19.0
 SEAT HEIGHT: 18.0-22.5
 BACK WIDTH: 20.0
 BACK HEIGHT: 19.0-21.5
 COM: 1.4 YDS
 COL: 20.0 SQ FT
 WEIGHT: 37.0 LB

bristol

seamless integration into your office's architecture

HIGH-BACK

GSA SIN # 711-18

- Management, task, stool, and conference seating
- Ratchet back height adjustment on all models
- Warranted up to 250 lbs with S2, R1, P1
- Warranted up to 300 lbs with M1, Y2
- CAL TB 133 Fire Code approved



CREATING BRISTOL MODEL NUMBER

MODEL NUMBER CONTROL ARMS GRADE CASTERS PACKAGING OPTIONS

2 3 8 0 - [] [] - A [] [] - [] [] - C 6 [] [] [] [] [] []

* FOR ARMLESS CODE USE A00 * GT MODELS DO NOT HAVE A CASTER CODE

PACKAGING NOTES

CODE	DESCRIPTION	LIST UPCHARGE
AB	ASSEMBLED IN BAG FOR WILL CALL	\$0
PAC	PARTIALLY ASSEMBLED IN CARTON	\$0
BAC	BACK ASSEMBLED IN CARTON	\$40

MODEL CONTROL DESCRIPTION

ARM

FABRIC/LEATHER

FEATURES

DIMENSIONS

ARM OPTIONS



HIGH-BACK SWIVEL TILT CONTROL

Use for a variety of general office task seating, including private office and conference room seating.

ARM	A/COM	B	C	D	E	F	G	L3/COL	L4	L5
ARMLESS	555	605	635	685	740	800	865	715	800	935
A8B / A8S	640	690	720	770	825	885	950	800	885	1020
A9B / A9S	660	710	740	790	845	905	970	820	905	1040
A10	640	690	720	770	825	885	950	800	885	1020
A19	755	805	835	885	940	1000	1065	915	1000	1135
A36	660	710	740	790	845	905	970	820	905	1040
A37	680	730	760	810	865	925	990	840	925	1060

SEAT SLIDER (SS) - ADD \$60

- Pneumatic Seat Height Adjustment
- Tilt Tension Control
- Seat and Back Tilt as a Unit
- Upright Position Tilt Lock
- Ratchet Back Height Lumbar Adjustment
- Rated for 250 lbs

WIDTH: 25.0
DEPTH: 26.0
HEIGHT: 42.0-49.0
SEAT WIDTH: 20.0
SEAT DEPTH: 19.0
SEAT HEIGHT: 17.0-21.5
BACK WIDTH: 20.0
BACK HEIGHT: 23.0-25.5
COM: 1.5 YDS
COL: 19.0 SQ FT
WEIGHT: 31.0 LB

A9B/S
\$105

A10
\$85

A19
\$200

A8 2-Way Height Adjustable Arm, A9 4-Way Adjustable Height Adjustable with 4" Interior Width Adjustment
A8B -Black, A8S -Silver
A9B -Black, A9S -Silver

Black Soft Touch Cantilever Style C-Shape Arm

Polished Aluminum C-Shape Arm

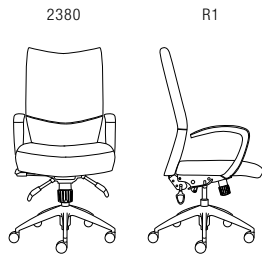

HIGH-BACK ROCKING CONTROL

For managerial and task applications. Similar to a swivel tilt control, with the added comfort of infinite back angle and tilt adjustment.

ARM	A/COM	B	C	D	E	F	G	L3/COL	L4	L5
ARMLESS	605	655	685	735	790	850	915	765	850	985
A8B / A8S	690	740	770	820	875	935	1000	850	935	1070
A9B / A9S	710	760	790	840	895	955	1020	870	955	1090
A10	690	740	770	820	875	935	1000	850	935	1070
A19	805	855	885	935	990	1050	1115	965	1050	1185
A36	710	760	790	840	895	955	1020	870	955	1090
A37	730	780	810	860	915	975	1040	890	975	1110

SEAT SLIDER (SS) - ADD \$60

- Pneumatic Seat Height Adjustment
- Tilt Tension Control
- Seat and Back Tilt as a Unit
- Floating Seat Position Tilt Lock
- Infinite Back Angle Adj w/ Free Float
- Ratchet Back Height Lumbar Adjustment
- Rated for 250 lbs

WIDTH: 25.0
DEPTH: 26.0
HEIGHT: 42.0-49.0
SEAT WIDTH: 20.0
SEAT DEPTH: 19.0
SEAT HEIGHT: 18.0-22.5
BACK WIDTH: 20.0
BACK HEIGHT: 23.0-25.5
COM: 1.5 YDS
COL: 19.0 SQ FT
WEIGHT: 36.0 LB

A36
\$105

A37
\$125

8-Way Adjustable Arms Soft-Touch sliding and pivoting arm pads.

10-Way Adjustable Arms Soft-Touch sliding and pivoting arm pads and 4" arm width knob under seat.

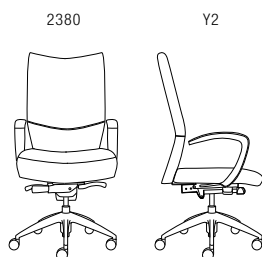

HIGH-BACK HEAVY DUTY SYNCHRO TILT CONTROL

Use for a variety of general office task seating, including private office and conference room seating.

ARM	A/COM	B	C	D	E	F	G	L3/COL	L4	L5
ARMLESS	635	685	715	765	820	880	945	795	880	1015
A8B / A8S	720	770	800	850	905	965	1030	880	965	1100
A9B / A9S	740	790	820	870	925	985	1050	900	985	1120
A10	720	770	800	850	905	965	1030	880	965	1100
A19	835	885	915	965	1020	1080	1145	995	1080	1215
A36	740	790	820	870	925	985	1050	900	985	1120
A37	760	810	840	890	945	1005	1070	920	1005	1140

SEAT SLIDER (SS) - ADD \$60

- Pneumatic Seat Height Adjustment
- Side Tilt Tension Control
- Back and Seat Tilt in 2:1 ratio
- 4 Locking Positions
- Safety Tilt Release
- Ratchet Back Height Lumbar Adjustment
- Rated for 300 lbs

WIDTH: 25.0
DEPTH: 26.0
HEIGHT: 42.0-49.0
SEAT WIDTH: 20.0
SEAT DEPTH: 19.0
SEAT HEIGHT: 18.0-22.5
BACK WIDTH: 20.0
BACK HEIGHT: 23.0-25.5
COM: 1.5 YDS
COL: 19.0 SQ FT
WEIGHT: 38.0 LB

C6
STD

C6S
\$35

Standard 60mm Hoodless Casters

60mm Hoodless Hard Floor Casters

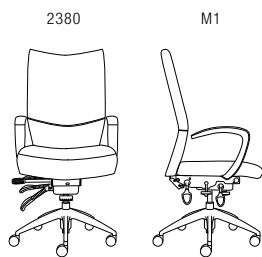

HIGH-BACK MULTIFUNCTION CONTROL

Fully articulating seat and back for the highest level of ergonomic needs. Control allows user to pivot seat forward from 0° to 6°.

ARM	A/COM	B	C	D	E	F	G	L3/COL	L4	L5
ARMLESS	655	705	735	785	840	900	965	815	900	1035
A8B / A8S	740	790	820	870	925	985	1050	900	985	1120
A9B / A9S	760	810	840	890	945	1005	1070	920	1005	1140
A10	740	790	820	870	925	985	1050	900	985	1120
A19	855	905	935	985	1040	1100	1165	1015	1100	1235
A36	760	810	840	890	945	1005	1070	920	1005	1140
A37	780	830	860	910	965	1025	1090	940	1025	1160

SEAT SLIDER (SS) - ADD \$60

- Pneumatic Seat Height Adjustment
- Tilt Tension Control
- Seat and Back Tilt as a Unit
- Floating Seat Position Tilt Lock
- Infinite Back Angle Adj w/ Free Float
- Seat Pivots from 0° to 6° Forward
- Ratchet Back Height Lumbar Adjustment
- Rated for 300 lbs

WIDTH: 25.0
DEPTH: 26.0
HEIGHT: 42.0-49.0
SEAT WIDTH: 20.0
SEAT DEPTH: 19.0
SEAT HEIGHT: 18.0-22.5
BACK WIDTH: 20.0
BACK HEIGHT: 23.0-25.5
COM: 1.5 YDS
COL: 19.0 SQ FT
WEIGHT: 40.0 LB

SS
\$60

BN1
\$35

BA10B
BA10P
BA10S
\$100

Seat Slider 2.5" Side Paddle Activated

Upholstered Outer Back in Black Ballistic Nylon
BN1 - with Grade A ONLY
BN2 - with Grade B and Up

26" High Profile Aluminum Base
BA10B - Black Powder-Coat
BA10P - Polished
BA10S - Silver Powder-Coat

bristol

seamless integration into your office's architecture

STOOL

GSA SIN # 711-18

- Management, task, stool, and conference seating
- Ratchet back height adjustment on all models
- Warranted up to 250 lbs with S2, R1, P1
- CAL 133 approved in fabric



CREATING BRISTOL MODEL NUMBER

MODEL NUMBER CONTROL ARMS GRADE CASTERS PACKAGING OPTIONS
2 3 6 - **P 1** - **A** - - - **C 6** - - - - -

PACKAGING NOTES

CODE	DESCRIPTION	LIST UPCHARGE
AB	ASSEMBLED IN BAG FOR WILL CALL	\$0
PAC	PARTIALLY ASSEMBLED IN CARTON	\$0
BAC	BACK ASSEMBLED IN CARTON	\$40

MODEL **CONTROL** **DESCRIPTION**

2366 P1

10" TRAVEL HIGH STOOL WITH POSTURE BACK CONTROL

Use for work surfaces up to 42 inches high.

ARM **FABRIC/LEATHER**

ARM	A/COM	B	C	D	E	F	G	L3/COL	L4	L5
ARMLESS	670	720	750	800	855	915	980	830	905	1065
A8B / A8S	755	805	835	885	940	1000	1065	915	990	1150
A9B / A9S	775	825	855	905	960	1020	1085	935	1010	1170
A10	755	805	835	885	940	1000	1065	915	990	1150
A19	870	920	950	1000	1055	1115	1180	1030	1105	1265
A36	775	825	855	905	960	1020	1085	935	1010	1170
A37	795	845	875	925	980	1040	1105	955	1030	1190

SEAT SLIDER (SS) - NOT AVAILABLE

FEATURES

- Pneumatic Seat Height Adjustment
- Infinite back angle adjust with free float
- Ratchet Back Height Lumbar Adjustment
- Height Adjustable Footring
- Rated for 250 lbs

DIMENSIONS

WIDTH: 25.0
DEPTH: 26.0
HEIGHT: 48.5-61.0
SEAT WIDTH: 20.0
SEAT DEPTH: 19.0
SEAT HEIGHT: 28.0-38.0
BACK WIDTH: 20.0
BACK HEIGHT: 19.0-21.5
COM: 1.4 YDS
COL: 20.0 SQ FT
WEIGHT: 42.0 LB

ARM OPTIONS

A9B/S
\$105

A8B/S
\$85

A10
\$85

A19
\$200

A8 2-Way Height Adjustable Arm, A9 4-Way Adjustable Height Adjustable with 4" Interior Width Adjustment
A8B -Black, A8S -Silver
A9B -Black, A9S -Silver

Black Soft Touch Cantilever Style C-Shape Arm

Polished Aluminum C-Shape Arm

MODEL **CONTROL** **DESCRIPTION**

2368 P1

8" TRAVEL LOW STOOL WITH POSTURE BACK CONTROL

Use for work surfaces up to 36 inches high.

ARM **FABRIC/LEATHER**

ARM	A/COM	B	C	D	E	F	G	L3/COL	L4	L5
ARMLESS	670	720	750	800	855	915	980	830	905	1065
A8B / A8S	755	805	835	885	940	1000	1065	915	990	1150
A9B / A9S	775	825	855	905	960	1020	1085	935	1010	1170
A10	755	805	835	885	940	1000	1065	915	990	1150
A19	870	920	950	1000	1055	1115	1180	1030	1105	1265
A36	775	825	855	905	960	1020	1085	935	1010	1170
A37	795	845	875	925	980	1040	1105	955	1030	1190

SEAT SLIDER (SS) - NOT AVAILABLE

FEATURES

- Pneumatic Seat Height Adjustment
- Infinite back angle adjust with free float
- Ratchet Back Height Lumbar Adjustment
- Height Adjustable Footring
- Rated for 250 lbs

DIMENSIONS

WIDTH: 25.0
DEPTH: 26.0
HEIGHT: 44.5-55.0
SEAT WIDTH: 20.0
SEAT DEPTH: 19.0
SEAT HEIGHT: 24.0-32.0
BACK WIDTH: 20.0
BACK HEIGHT: 19.0-21.5
COM: 1.4 YDS
COL: 20.0 SQ FT
WEIGHT: 43.0 LB

ARM OPTIONS

A36
\$105

A37
\$125

8-Way Adjustable Arms Soft-Touch sliding and pivoting arm pads.

10-Way Adjustable Arms Soft-Touch sliding and pivoting arm pads and 4" arm width knob under seat.

CASTER OPTIONS

C6
STD

C6S
\$35

Standard 60mm Hoodless Casters

60mm Hoodless Hard Floor Casters

ADDITIONAL OPTIONS

BN1
\$35
BN2
\$/C

BA10B
BA10P
BA10S
\$100

Upholstered Outer Back in Black Ballistic Nylon
BN1 - with Grade A ONLY
BN2 - with Grade B and Up

26" High Profile Aluminum Base
BA10B - Black Powder-Coat
BA10P - Polished
BA10S - Silver Powder-Coat

cayman

contemporary, ergonomic, and built with attention to detail

GSA SIN # 711-18

- Conference and executive seating
- Warranted up to 250 lbs, S1
- Warranted up to 300 lbs, K1
- Aluminum base standard matches arm finish



CREATING CAYMAN MODEL NUMBER

MODEL NUMBER CONTROL ARMS GRADE CASTERS PACKAGING OPTIONS

2 8 0 0 - [] [] - A [] [] - [] [] - [] [] [] [] - [] [] [] [] - [] [] [] []

* FOR ARMLESS CODE USE A00

* GT MODELS DO NOT HAVE A CASTER CODE

PACKAGING NOTES

CODE	DESCRIPTION	LIST UPCHARGE
AB	ASSEMBLED IN BAG FOR WILL CALL	\$0
BAC	BACK ASSEMBLED IN CARTON	\$0

MID-BACK

MODEL	CONTROL	DESCRIPTION	ARM	FABRIC/LEATHER	FEATURES	DIMENSIONS																														
2800	S1	<p>MID-BACK SWIVEL TILT CONTROL</p> <p>Use for a variety of general office seating, including private office and conference room seating.</p>	A20 A21	<table border="1"> <thead> <tr> <th>A/COM</th> <th>B</th> <th>C</th> <th>D</th> <th>E</th> <th>F</th> <th>G</th> <th>L3/COL</th> <th>L4</th> <th>L5</th> </tr> </thead> <tbody> <tr> <td>695</td> <td>755</td> <td>795</td> <td>855</td> <td>925</td> <td>1000</td> <td>1085</td> <td>850</td> <td>905</td> <td>1195</td> </tr> <tr> <td>695</td> <td>755</td> <td>795</td> <td>855</td> <td>925</td> <td>1000</td> <td>1085</td> <td>850</td> <td>905</td> <td>1195</td> </tr> </tbody> </table>	A/COM	B	C	D	E	F	G	L3/COL	L4	L5	695	755	795	855	925	1000	1085	850	905	1195	695	755	795	855	925	1000	1085	850	905	1195	<ul style="list-style-type: none"> • Pneumatic Seat Height Adjustment • Tilt Tension Control • Seat and Back Tilt as a Unit • Upright Position Tilt Lock • Rated for 250 lbs 	<p>WIDTH: 24.0</p> <p>DEPTH: 30.0</p> <p>HEIGHT: 39.0-43.5</p> <p>SEAT WIDTH: 21.0</p> <p>SEAT DEPTH: 19.5</p> <p>SEAT HEIGHT: 16.5-21.0</p> <p>BACK WIDTH: 22.0</p> <p>BACK HEIGHT: 22.5</p> <p>COM: 1.9 YDS</p> <p>COL: 25.0 SQ FT</p> <p>WEIGHT: 36.0 LB</p>
A/COM	B	C	D	E	F	G	L3/COL	L4	L5																											
695	755	795	855	925	1000	1085	850	905	1195																											
695	755	795	855	925	1000	1085	850	905	1195																											
2800	K1	<p>MID-BACK KNEE TILT CONTROL</p> <p>Ultimate seating comfort suited for the executive or manager. Allows for a full range of movement with a sharp, simple look.</p>	A20 A21	<table border="1"> <thead> <tr> <th>A/COM</th> <th>B</th> <th>C</th> <th>D</th> <th>E</th> <th>F</th> <th>G</th> <th>L3/COL</th> <th>L4</th> <th>L5</th> </tr> </thead> <tbody> <tr> <td>745</td> <td>805</td> <td>845</td> <td>905</td> <td>975</td> <td>1050</td> <td>1135</td> <td>900</td> <td>955</td> <td>1245</td> </tr> <tr> <td>745</td> <td>805</td> <td>845</td> <td>905</td> <td>975</td> <td>1050</td> <td>1135</td> <td>900</td> <td>955</td> <td>1245</td> </tr> </tbody> </table>	A/COM	B	C	D	E	F	G	L3/COL	L4	L5	745	805	845	905	975	1050	1135	900	955	1245	745	805	845	905	975	1050	1135	900	955	1245	<ul style="list-style-type: none"> • Pneumatic Seat Height Adjustment • Tilt Tension Control • Seat and Back Tilt as a Unit • 5 Locking Positions • Safety Tilt Release • Reduced Rise of Front of Seat • Rated for 300 lbs 	<p>WIDTH: 24.0</p> <p>DEPTH: 30.0</p> <p>HEIGHT: 39.0-43.5</p> <p>SEAT WIDTH: 21.0</p> <p>SEAT DEPTH: 19.5</p> <p>SEAT HEIGHT: 16.5-19.5</p> <p>BACK WIDTH: 22.0</p> <p>BACK HEIGHT: 22.5</p> <p>COM: 1.9 YDS</p> <p>COL: 25.0 SQ FT</p> <p>WEIGHT: 41.0 LB</p>
A/COM	B	C	D	E	F	G	L3/COL	L4	L5																											
745	805	845	905	975	1050	1135	900	955	1245																											
745	805	845	905	975	1050	1135	900	955	1245																											
2800	GT	<p>GUEST</p> <p>Well suited for guest seating. Comes standard with non-marking glides.</p>	A20 A21	<table border="1"> <thead> <tr> <th>A/COM</th> <th>B</th> <th>C</th> <th>D</th> <th>E</th> <th>F</th> <th>G</th> <th>L3/COL</th> <th>L4</th> <th>L5</th> </tr> </thead> <tbody> <tr> <td>625</td> <td>685</td> <td>725</td> <td>785</td> <td>855</td> <td>930</td> <td>1015</td> <td>780</td> <td>835</td> <td>1125</td> </tr> <tr> <td>625</td> <td>685</td> <td>725</td> <td>785</td> <td>855</td> <td>930</td> <td>1015</td> <td>780</td> <td>835</td> <td>1125</td> </tr> </tbody> </table>	A/COM	B	C	D	E	F	G	L3/COL	L4	L5	625	685	725	785	855	930	1015	780	835	1125	625	685	725	785	855	930	1015	780	835	1125	<ul style="list-style-type: none"> • Cantilever Frame Design • Non-Marring Floor Glides • Rated for 250 lbs 	<p>WIDTH: 24.0</p> <p>DEPTH: 30.0</p> <p>HEIGHT: 40.0</p> <p>SEAT WIDTH: 21.0</p> <p>SEAT DEPTH: 19.5</p> <p>SEAT HEIGHT: 18.0</p> <p>BACK WIDTH: 22.0</p> <p>BACK HEIGHT: 22.5</p> <p>COM: 1.9 YDS</p> <p>COL: 25.0 SQ FT</p> <p>WEIGHT: 38.0 LB</p>
A/COM	B	C	D	E	F	G	L3/COL	L4	L5																											
625	685	725	785	855	930	1015	780	835	1125																											
625	685	725	785	855	930	1015	780	835	1125																											

SHIPS PARTIALLY ASSEMBLED BAC OR AB

ARM OPTIONS

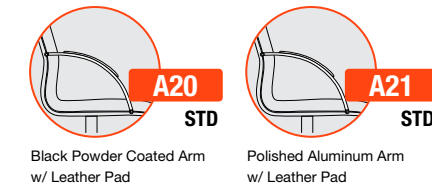

CASTER OPTIONS

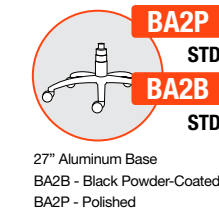

cayman

contemporary, ergonomic, and built with attention to detail

GSA SIN # 711-18

- Conference and executive seating
- Warranted up to 250 lbs, S1
- Warranted up to 300 lbs, K1
- Aluminum base standard matches arm finish



CREATING CAYMAN MODEL NUMBER

MODEL NUMBER CONTROL ARMS GRADE CASTERS PACKAGING OPTIONS

2 8 1 0 - [] [] - A [] [] - [] [] - [] [] [] - [] [] [] - [] [] []

* FOR ARMLESS CODE USE A00 * GT MODELS DO NOT HAVE A CASTER CODE

PACKAGING NOTES

CODE	DESCRIPTION	LIST UPCHARGE
AB	ASSEMBLED IN BAG FOR WILL CALL	\$0
BAC	BACK ASSEMBLED IN CARTON	\$0

HIGH-BACK

MODEL	CONTROL	DESCRIPTION	ARM	FABRIC/LEATHER	FEATURES	DIMENSIONS																				
2810	S1	HIGH-BACK SWIVEL TILT CONTROL Use for a variety of general office seating, including private office and conference room seating.	A20	<table border="1"> <thead> <tr> <th>A/COM</th> <th>B</th> <th>C</th> <th>D</th> <th>E</th> <th>F</th> <th>G</th> <th>L3/COL</th> <th>L4</th> <th>L5</th> </tr> </thead> <tbody> <tr> <td>745</td> <td>815</td> <td>860</td> <td>930</td> <td>1005</td> <td>1090</td> <td>1185</td> <td>900</td> <td>965</td> <td>1385</td> </tr> </tbody> </table>	A/COM	B	C	D	E	F	G	L3/COL	L4	L5	745	815	860	930	1005	1090	1185	900	965	1385	<ul style="list-style-type: none"> • Pneumatic Seat Height Adjustment • Tilt Tension Control • Seat and Back Tilt as a Unit • Upright Position Tilt Lock • Rated for 250 lbs 	WIDTH: 24.0 DEPTH: 30.0 HEIGHT: 43.0-47.5 SEAT WIDTH: 21.0 SEAT DEPTH: 19.5 SEAT HEIGHT: 16.5-21.0 BACK WIDTH: 22.0 BACK HEIGHT: 26.5 COM: 2.1 YDS COL: 42.0 SQ FT WEIGHT: 43.0 LB
A/COM	B		C	D	E	F	G	L3/COL	L4	L5																
745	815	860	930	1005	1090	1185	900	965	1385																	
		A21	<table border="1"> <thead> <tr> <th>A/COM</th> <th>B</th> <th>C</th> <th>D</th> <th>E</th> <th>F</th> <th>G</th> <th>L3/COL</th> <th>L4</th> <th>L5</th> </tr> </thead> <tbody> <tr> <td>745</td> <td>815</td> <td>860</td> <td>930</td> <td>1005</td> <td>1090</td> <td>1185</td> <td>900</td> <td>965</td> <td>1385</td> </tr> </tbody> </table>	A/COM	B	C	D	E	F	G	L3/COL	L4	L5	745	815	860	930	1005	1090	1185	900	965	1385			
A/COM	B	C	D	E	F	G	L3/COL	L4	L5																	
745	815	860	930	1005	1090	1185	900	965	1385																	

ARM OPTIONS

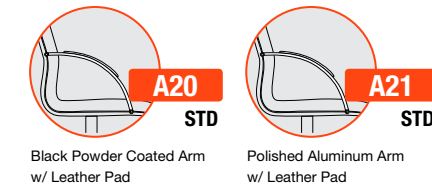

MODEL	CONTROL	DESCRIPTION	ARM	FABRIC/LEATHER	FEATURES	DIMENSIONS																				
2810	K1	HIGH-BACK KNEE TILT CONTROL Ultimate seating comfort suited for the executive or manager. Allows for a full range of movement with a sharp, simple look.	A20	<table border="1"> <thead> <tr> <th>A/COM</th> <th>B</th> <th>C</th> <th>D</th> <th>E</th> <th>F</th> <th>G</th> <th>L3/COL</th> <th>L4</th> <th>L5</th> </tr> </thead> <tbody> <tr> <td>795</td> <td>865</td> <td>910</td> <td>980</td> <td>1055</td> <td>1140</td> <td>1235</td> <td>950</td> <td>1015</td> <td>1435</td> </tr> </tbody> </table>	A/COM	B	C	D	E	F	G	L3/COL	L4	L5	795	865	910	980	1055	1140	1235	950	1015	1435	<ul style="list-style-type: none"> • Pneumatic Seat Height Adjustment • Tilt Tension Control • Seat and Back Tilt as a Unit • 5 Locking Positions • Safety Tilt Release • Reduced Rise of Front of Seat • Rated for 300 lbs 	WIDTH: 24.0 DEPTH: 30.0 HEIGHT: 43.0-46.0 SEAT WIDTH: 21.0 SEAT DEPTH: 19.5 SEAT HEIGHT: 16.5-19.5 BACK WIDTH: 26.5 BACK HEIGHT: 2.1 YDS COM: 42.0 SQ FT COL: 48.0 LB WEIGHT:
A/COM	B		C	D	E	F	G	L3/COL	L4	L5																
795	865	910	980	1055	1140	1235	950	1015	1435																	
		A21	<table border="1"> <thead> <tr> <th>A/COM</th> <th>B</th> <th>C</th> <th>D</th> <th>E</th> <th>F</th> <th>G</th> <th>L3/COL</th> <th>L4</th> <th>L5</th> </tr> </thead> <tbody> <tr> <td>795</td> <td>865</td> <td>910</td> <td>980</td> <td>1055</td> <td>1140</td> <td>1235</td> <td>950</td> <td>1015</td> <td>1435</td> </tr> </tbody> </table>	A/COM	B	C	D	E	F	G	L3/COL	L4	L5	795	865	910	980	1055	1140	1235	950	1015	1435			
A/COM	B	C	D	E	F	G	L3/COL	L4	L5																	
795	865	910	980	1055	1140	1235	950	1015	1435																	

CASTER OPTIONS

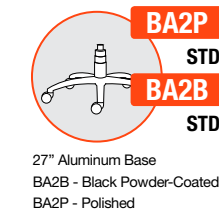

core

contemporary lines for your workspace

NEW UPHOLSTERED BACK

GSA SIN # 711-18 Pending

- Stylish durable poly outer back
- Ratchet height adjustable back
- Weight balanced knee tilt or Synchro control
- Durable hubless casters
- Optional seat slider
- Fixed or adjustable t-arms
- Black or gray accent colors
- Molded foam back over mesh suspension
- Warranted up to 300 lbs



CREATING CORE MODEL NUMBER

MODEL NUMBER CONTROL ARMS PLASTIC COLOR GRADE CASTERS PACKAGING OPTIONS

2 2 6 0 - [] [] - A [] [] - P [] [] - C [] [] [] [] - [] [] [] [] - [] [] [] []

* GT MODELS DO NOT HAVE A CASTER CODE

PLASTIC COLORS

CODE	DESCRIPTION
PGA	GRAY
PBA	BLACK

PACKAGING NOTES

CODE	DESCRIPTION	LIST UPCHARGE
AB	ASSEMBLED IN BAG FOR WILL CALL	\$0
PAC	PARTIALLY ASSEMBLED IN CARTON	\$0
BAC	BACK ASSEMBLED IN CARTON	\$40

MODEL	CONTROL	DESCRIPTION	ARM	FABRIC	FEATURES	DIMENSIONS	ARM OPTIONS	CASTER OPTIONS	ADDITIONAL OPTIONS																																																												
NEW MODEL 2260	W1	RATCHET BACK WEIGHT BALANCED Use for a variety of general office seating, including private office and conference room seating	ARMLESS A22 A23 A36 A37	<table border="1"> <thead> <tr> <th>A/COM</th> <th>B</th> <th>C</th> <th>D</th> <th>E</th> <th>F</th> <th>G</th> <th>L3/COL</th> <th>L4</th> <th>L5</th> </tr> </thead> <tbody> <tr><td>495</td><td>530</td><td>550</td><td>585</td><td>620</td><td>660</td><td>705</td><td>595</td><td>795</td><td>845</td></tr> <tr><td>545</td><td>580</td><td>600</td><td>635</td><td>670</td><td>710</td><td>755</td><td>645</td><td>845</td><td>895</td></tr> <tr><td>570</td><td>605</td><td>625</td><td>660</td><td>695</td><td>735</td><td>780</td><td>670</td><td>870</td><td>920</td></tr> <tr><td>600</td><td>635</td><td>655</td><td>690</td><td>725</td><td>765</td><td>810</td><td>700</td><td>900</td><td>950</td></tr> <tr><td>620</td><td>655</td><td>675</td><td>710</td><td>745</td><td>785</td><td>830</td><td>720</td><td>920</td><td>970</td></tr> </tbody> </table>	A/COM	B	C	D	E	F	G	L3/COL	L4	L5	495	530	550	585	620	660	705	595	795	845	545	580	600	635	670	710	755	645	845	895	570	605	625	660	695	735	780	670	870	920	600	635	655	690	725	765	810	700	900	950	620	655	675	710	745	785	830	720	920	970	<ul style="list-style-type: none"> • Pneumatic Seat Height Adjustment • Weight Balanced Control with Body Adjust • Back and Seat Tilt in 3:1 Ratio • 2 Position Tilt Lock • Ratchet Back Height Lumbar Adjustment • Molded Foam Seat • Molded Foam Back Over Mesh Suspension • Hubless Casters • Rated for 300 lbs 	<p>WIDTH: 27.5 DEPTH: 27.5 HEIGHT: 42.75-48.00</p> <p>SEAT WIDTH: 19.0 SEAT DEPTH: 16.8 SEAT HEIGHT: 18.25-22.75 BACK WIDTH: 18.0 BACK HEIGHT: 24.0</p> <p>COM: 1YD COL: 8 SQ FT WEIGHT: 39.0 LB</p>	<p>A22 \$50 Fixed Arm with Soft Polyurethane pad in black or gray</p> <p>A23 \$75 6-way adjustable arm for height, width, and sliding arm pads in black or gray</p>		
A/COM	B	C	D	E	F	G	L3/COL	L4	L5																																																												
495	530	550	585	620	660	705	595	795	845																																																												
545	580	600	635	670	710	755	645	845	895																																																												
570	605	625	660	695	735	780	670	870	920																																																												
600	635	655	690	725	765	810	700	900	950																																																												
620	655	675	710	745	785	830	720	920	970																																																												
NEW MODEL 2260	K2	RATCHET BACK ENHANCED KNEE TILT CONTROL Ultimate seating comfort suited for the executive or manager. Allows for full range of movement with sharp, simple look	ARMLESS A22 A23 A36 A37	<table border="1"> <thead> <tr> <th>A/COM</th> <th>B</th> <th>C</th> <th>D</th> <th>E</th> <th>F</th> <th>G</th> <th>L3/COL</th> <th>L4</th> <th>L5</th> </tr> </thead> <tbody> <tr><td>525</td><td>560</td><td>580</td><td>615</td><td>650</td><td>690</td><td>735</td><td>625</td><td>825</td><td>875</td></tr> <tr><td>575</td><td>610</td><td>630</td><td>665</td><td>700</td><td>740</td><td>785</td><td>675</td><td>875</td><td>925</td></tr> <tr><td>600</td><td>635</td><td>655</td><td>690</td><td>725</td><td>765</td><td>810</td><td>700</td><td>900</td><td>950</td></tr> <tr><td>630</td><td>665</td><td>685</td><td>720</td><td>755</td><td>795</td><td>840</td><td>730</td><td>930</td><td>980</td></tr> <tr><td>650</td><td>685</td><td>705</td><td>740</td><td>775</td><td>815</td><td>860</td><td>750</td><td>950</td><td>1000</td></tr> </tbody> </table>	A/COM	B	C	D	E	F	G	L3/COL	L4	L5	525	560	580	615	650	690	735	625	825	875	575	610	630	665	700	740	785	675	875	925	600	635	655	690	725	765	810	700	900	950	630	665	685	720	755	795	840	730	930	980	650	685	705	740	775	815	860	750	950	1000	<ul style="list-style-type: none"> • Pneumatic Seat Height Adjustment • Knee Tilt Control • Seat and Back Tilt as One Unit • 3 Position Tilt Lock • Ratchet Back Height Lumbar Adjustment • Molded Foam Seat • Molded Foam Back Over Mesh Suspension • Hubless Casters • Rated for 300 lbs 	<p>WIDTH: 27.5 DEPTH: 27.5 HEIGHT: 42.75-48.00</p> <p>SEAT WIDTH: 19.0 SEAT DEPTH: 16.8 SEAT HEIGHT: 18.25-22.75 BACK WIDTH: 18.0 BACK HEIGHT: 24.0</p> <p>COM: 1YD COL: 8 SQ FT WEIGHT: 39.0 LB</p>	<p>A36 \$105 8-Way Adjustable Arms Soft-Touch sliding and pivoting arm pads.</p>		
A/COM	B	C	D	E	F	G	L3/COL	L4	L5																																																												
525	560	580	615	650	690	735	625	825	875																																																												
575	610	630	665	700	740	785	675	875	925																																																												
600	635	655	690	725	765	810	700	900	950																																																												
630	665	685	720	755	795	840	730	930	980																																																												
650	685	705	740	775	815	860	750	950	1000																																																												
NEW MODEL 2260	Y5	RACHET BACK ADJUSTABLE BACK SYNCHRO TILT CONTROL High function full synchro control with independent back angle adjust. Use for general office, task, or management	ARMLESS A22 A23 A36 A37	<table border="1"> <thead> <tr> <th>A/COM</th> <th>B</th> <th>C</th> <th>D</th> <th>E</th> <th>F</th> <th>G</th> <th>L3/COL</th> <th>L4</th> <th>L5</th> </tr> </thead> <tbody> <tr><td>575</td><td>610</td><td>630</td><td>665</td><td>700</td><td>740</td><td>785</td><td>675</td><td>875</td><td>925</td></tr> <tr><td>625</td><td>660</td><td>680</td><td>715</td><td>750</td><td>790</td><td>835</td><td>725</td><td>925</td><td>975</td></tr> <tr><td>650</td><td>685</td><td>705</td><td>740</td><td>775</td><td>815</td><td>860</td><td>750</td><td>950</td><td>1000</td></tr> <tr><td>680</td><td>715</td><td>735</td><td>770</td><td>805</td><td>845</td><td>890</td><td>780</td><td>980</td><td>1030</td></tr> <tr><td>700</td><td>735</td><td>755</td><td>790</td><td>825</td><td>865</td><td>910</td><td>800</td><td>1000</td><td>1050</td></tr> </tbody> </table>	A/COM	B	C	D	E	F	G	L3/COL	L4	L5	575	610	630	665	700	740	785	675	875	925	625	660	680	715	750	790	835	725	925	975	650	685	705	740	775	815	860	750	950	1000	680	715	735	770	805	845	890	780	980	1030	700	735	755	790	825	865	910	800	1000	1050	<ul style="list-style-type: none"> • Pneumatic Seat Height Adjustment • Full Synchro with Independent Angle Adjust • 2:1 Back to Seat Ratio • Standard Seat Slider Adds 3" Adjustment • 4 Locking Positions • Ratchet Back Height Lumbar Adjustment • Molded Foam Seat • Molded Foam Back Over Mesh Suspension • Side Tension Control • Hubless Casters • Rated for 300 lbs 	<p>WIDTH: 27.5 DEPTH: 27.5 HEIGHT: 42.75-48.00</p> <p>SEAT WIDTH: 19.0 SEAT DEPTH: 16.8 SEAT HEIGHT: 18.25-22.75 BACK WIDTH: 18.0 BACK HEIGHT: 24.0</p> <p>COM: 1YD COL: 8 SQ FT WEIGHT: 39.0 LB</p>	<p>C22B STD Standard 60mm Black Hubless Casters</p> <p>C22G STD Standard 60mm Hubless Gray Casters</p> <p>C6 \$30 60mm Hoodless Casters</p> <p>C6S \$35 60mm Hoodless Hard Floor Casters</p>		
A/COM	B	C	D	E	F	G	L3/COL	L4	L5																																																												
575	610	630	665	700	740	785	675	875	925																																																												
625	660	680	715	750	790	835	725	925	975																																																												
650	685	705	740	775	815	860	750	950	1000																																																												
680	715	735	770	805	845	890	780	980	1030																																																												
700	735	755	790	825	865	910	800	1000	1050																																																												
NEW MODEL 2260	GT	GUEST Four leg steel frame side chair	SWA	<table border="1"> <thead> <tr> <th>A/COM</th> <th>B</th> <th>C</th> <th>D</th> <th>E</th> <th>F</th> <th>G</th> <th>L3/COL</th> <th>L4</th> <th>L5</th> </tr> </thead> <tbody> <tr><td>450</td><td>485</td><td>505</td><td>540</td><td>575</td><td>615</td><td>660</td><td>550</td><td>750</td><td>800</td></tr> </tbody> </table>	A/COM	B	C	D	E	F	G	L3/COL	L4	L5	450	485	505	540	575	615	660	550	750	800	<ul style="list-style-type: none"> • 4 Leg Frame Design • Non-Marring Floor Glides • Black or Gray Accents • Black or Silver Frame • Rated for 300 lbs 	<p>WIDTH: 26.0 DEPTH: 28.0 HEIGHT: 39.0</p> <p>SEAT WIDTH: 20.0 SEAT DEPTH: 16.5 SEAT HEIGHT: 17.5 BACK WIDTH: 20.0 BACK HEIGHT: 22.0</p> <p>COM: 1YD COL: 8 SQ FT WEIGHT: 38.0 LB</p>	<p>BA11 STD 27" Mid-Profile Plastic Base B - Black Plastic G - Gray Plastic</p> <p>BA12P \$100 27" High Profile Polished Aluminum Base</p> <p>SS \$60 Seat Slider 2.5" Side Paddle Activated</p>																																										
A/COM	B	C	D	E	F	G	L3/COL	L4	L5																																																												
450	485	505	540	575	615	660	550	750	800																																																												

SHIPS PARTIALLY ASSEMBLED PAC OR AB / SWA - STANDARD WITH ARMS

AVAILABLE JANUARY 2017

cortina

simple, straightforward ergonomics and functionality

MID-BACK

GSA SIN # 711-18

- Task, conference and executive seating
- Aluminum base standard
- Warranted up to 250 lbs with S2, GT
- Warranted up to 300 lbs with M1, Y2
- CAL TB 133 Fire Code approved
- GT available in black or chrome frame



CREATING CORTINA MODEL NUMBER

MODEL NUMBER CONTROL ARMS GRADE CASTERS PACKAGING OPTIONS

2 9 0 0 - [] [] - A [] [] - [] [] - C [] [] - [] [] - [] []

* END 4 DIGIT CODE (SEE PAGE 100) * 2T MODEL & DO NOT USE A 1-DIGIT CODE

PACKAGING NOTES

CODE	DESCRIPTION	LIST UPCHARGE
AB	ASSEMBLED IN BAG FOR WILL CALL	\$0
BAC	BACK ASSEMBLED IN CARTON	\$40

MODEL	CONTROL	DESCRIPTION	ARM	FABRIC/LEATHER	FEATURES	DIMENSIONS	ARM OPTIONS	CASTER OPTIONS	ADDITIONAL OPTIONS																																																																																
2900	S2	MID-BACK SWIVEL TILT CONTROL Use for a variety of general office seating, including private office and conference room seating.	<ul style="list-style-type: none"> ARMLESS A8B / A8S A9B / A9S A16 A19 A36 A37 	<table border="1"> <thead> <tr> <th>A/COM</th> <th>B</th> <th>C</th> <th>D</th> <th>E</th> <th>F</th> <th>G</th> <th>L3/COL</th> <th>L4</th> <th>L5</th> </tr> </thead> <tbody> <tr><td>600</td><td>655</td><td>690</td><td>745</td><td>805</td><td>870</td><td>940</td><td>750</td><td>850</td><td>990</td></tr> <tr><td>685</td><td>740</td><td>775</td><td>830</td><td>890</td><td>955</td><td>1025</td><td>835</td><td>935</td><td>1075</td></tr> <tr><td>705</td><td>760</td><td>795</td><td>850</td><td>910</td><td>975</td><td>1045</td><td>855</td><td>955</td><td>1095</td></tr> <tr><td>700</td><td>755</td><td>790</td><td>845</td><td>905</td><td>970</td><td>1040</td><td>850</td><td>950</td><td>1090</td></tr> <tr><td>800</td><td>855</td><td>890</td><td>945</td><td>1005</td><td>1070</td><td>1140</td><td>950</td><td>1050</td><td>1190</td></tr> <tr><td>705</td><td>760</td><td>795</td><td>850</td><td>910</td><td>975</td><td>1045</td><td>855</td><td>955</td><td>1095</td></tr> <tr><td>725</td><td>780</td><td>815</td><td>870</td><td>930</td><td>995</td><td>1065</td><td>875</td><td>975</td><td>1115</td></tr> </tbody> </table>	A/COM	B	C	D	E	F	G	L3/COL	L4	L5	600	655	690	745	805	870	940	750	850	990	685	740	775	830	890	955	1025	835	935	1075	705	760	795	850	910	975	1045	855	955	1095	700	755	790	845	905	970	1040	850	950	1090	800	855	890	945	1005	1070	1140	950	1050	1190	705	760	795	850	910	975	1045	855	955	1095	725	780	815	870	930	995	1065	875	975	1115	<ul style="list-style-type: none"> • Pneumatic Seat Height Adjustment • Tilt Tension Control • Seat and Back Tilt as a Unit • Upright Position Tilt Lock • Rated for 250 lbs 	<p>WIDTH: 25.0</p> <p>DEPTH: 26.0</p> <p>HEIGHT: 39.0-43.5</p> <p>SEAT WIDTH: 20.5</p> <p>SEAT DEPTH: 19.0</p> <p>BACK HEIGHT: 18.0-22.5</p> <p>BACK WIDTH: 18.5</p> <p>COM: 1.6 YD</p> <p>COL: 20.0 SQ FT</p> <p>WEIGHT: 44.0 LB</p>	<ul style="list-style-type: none"> A9B/S \$105 A8B/S \$85 A16 \$100 A19 \$200 		
A/COM	B	C	D	E	F	G	L3/COL	L4	L5																																																																																
600	655	690	745	805	870	940	750	850	990																																																																																
685	740	775	830	890	955	1025	835	935	1075																																																																																
705	760	795	850	910	975	1045	855	955	1095																																																																																
700	755	790	845	905	970	1040	850	950	1090																																																																																
800	855	890	945	1005	1070	1140	950	1050	1190																																																																																
705	760	795	850	910	975	1045	855	955	1095																																																																																
725	780	815	870	930	995	1065	875	975	1115																																																																																
2900	Y2	MID-BACK SYNCHRO TILT CONTROL Use for a variety of general office seating, including private office and conference room seating.	<ul style="list-style-type: none"> ARMLESS A8B / A8S A9B / A9S A16 A19 A36 A37 	<table border="1"> <thead> <tr> <th>A/COM</th> <th>B</th> <th>C</th> <th>D</th> <th>E</th> <th>F</th> <th>G</th> <th>L3/COL</th> <th>L4</th> <th>L5</th> </tr> </thead> <tbody> <tr><td>680</td><td>735</td><td>770</td><td>825</td><td>885</td><td>950</td><td>1020</td><td>830</td><td>865</td><td>1070</td></tr> <tr><td>765</td><td>820</td><td>855</td><td>910</td><td>970</td><td>1035</td><td>1105</td><td>915</td><td>950</td><td>1155</td></tr> <tr><td>785</td><td>840</td><td>875</td><td>930</td><td>990</td><td>1055</td><td>1125</td><td>935</td><td>970</td><td>1175</td></tr> <tr><td>780</td><td>835</td><td>870</td><td>925</td><td>985</td><td>1050</td><td>1120</td><td>930</td><td>965</td><td>1170</td></tr> <tr><td>880</td><td>935</td><td>970</td><td>1025</td><td>1085</td><td>1150</td><td>1220</td><td>1030</td><td>1065</td><td>1270</td></tr> <tr><td>785</td><td>840</td><td>875</td><td>930</td><td>990</td><td>1055</td><td>1125</td><td>935</td><td>970</td><td>1175</td></tr> <tr><td>805</td><td>860</td><td>895</td><td>950</td><td>1010</td><td>1075</td><td>1145</td><td>955</td><td>990</td><td>1195</td></tr> </tbody> </table>	A/COM	B	C	D	E	F	G	L3/COL	L4	L5	680	735	770	825	885	950	1020	830	865	1070	765	820	855	910	970	1035	1105	915	950	1155	785	840	875	930	990	1055	1125	935	970	1175	780	835	870	925	985	1050	1120	930	965	1170	880	935	970	1025	1085	1150	1220	1030	1065	1270	785	840	875	930	990	1055	1125	935	970	1175	805	860	895	950	1010	1075	1145	955	990	1195	<ul style="list-style-type: none"> • Pneumatic Seat Height Adjustment • Back and Seat Tilt in 2:1 ratio • 4 Locking Positions • Safety Tilt Release • Reduced Rise of Front of Seat • Synchro Control • Side Tension Adjustment • Rated for 300 lbs 	<p>WIDTH: 25.0</p> <p>DEPTH: 26.0</p> <p>HEIGHT: 39.0-43.5</p> <p>SEAT WIDTH: 20.5</p> <p>SEAT DEPTH: 19.0</p> <p>BACK HEIGHT: 18.0-22.5</p> <p>BACK WIDTH: 18.5</p> <p>COM: 1.6 YD</p> <p>COL: 20.0 SQ FT</p> <p>WEIGHT: 49.0 LB</p>	<ul style="list-style-type: none"> A36 \$105 A37 \$125 		
A/COM	B	C	D	E	F	G	L3/COL	L4	L5																																																																																
680	735	770	825	885	950	1020	830	865	1070																																																																																
765	820	855	910	970	1035	1105	915	950	1155																																																																																
785	840	875	930	990	1055	1125	935	970	1175																																																																																
780	835	870	925	985	1050	1120	930	965	1170																																																																																
880	935	970	1025	1085	1150	1220	1030	1065	1270																																																																																
785	840	875	930	990	1055	1125	935	970	1175																																																																																
805	860	895	950	1010	1075	1145	955	990	1195																																																																																
2900	M1	MID-BACK MULTIFUNCTION CONTROL Fully articulating seat and back for the highest level of ergonomic needs. Control allows user to pivot seat forward from 0° to 6°.	<ul style="list-style-type: none"> ARMLESS A8B / A8S A9B / A9S A16 A19 A36 A37 	<table border="1"> <thead> <tr> <th>A/COM</th> <th>B</th> <th>C</th> <th>D</th> <th>E</th> <th>F</th> <th>G</th> <th>L3/COL</th> <th>L4</th> <th>L5</th> </tr> </thead> <tbody> <tr><td>700</td><td>755</td><td>790</td><td>845</td><td>905</td><td>970</td><td>1040</td><td>850</td><td>885</td><td>1090</td></tr> <tr><td>785</td><td>840</td><td>875</td><td>930</td><td>990</td><td>1055</td><td>1125</td><td>935</td><td>970</td><td>1175</td></tr> <tr><td>805</td><td>860</td><td>895</td><td>950</td><td>1010</td><td>1075</td><td>1145</td><td>955</td><td>990</td><td>1195</td></tr> <tr><td>800</td><td>855</td><td>890</td><td>945</td><td>1005</td><td>1070</td><td>1140</td><td>950</td><td>985</td><td>1190</td></tr> <tr><td>900</td><td>955</td><td>990</td><td>1045</td><td>1105</td><td>1170</td><td>1240</td><td>1050</td><td>1085</td><td>1290</td></tr> <tr><td>805</td><td>860</td><td>895</td><td>950</td><td>1010</td><td>1075</td><td>1145</td><td>955</td><td>990</td><td>1195</td></tr> <tr><td>825</td><td>880</td><td>915</td><td>970</td><td>1030</td><td>1095</td><td>1165</td><td>975</td><td>1010</td><td>1215</td></tr> </tbody> </table>	A/COM	B	C	D	E	F	G	L3/COL	L4	L5	700	755	790	845	905	970	1040	850	885	1090	785	840	875	930	990	1055	1125	935	970	1175	805	860	895	950	1010	1075	1145	955	990	1195	800	855	890	945	1005	1070	1140	950	985	1190	900	955	990	1045	1105	1170	1240	1050	1085	1290	805	860	895	950	1010	1075	1145	955	990	1195	825	880	915	970	1030	1095	1165	975	1010	1215	<ul style="list-style-type: none"> • Pneumatic Seat Height Adjustment • Tilt Tension Control • Seat and Back Tilt as a Unit • Infinite Tilt Position Lock • Infinite Back Angle Adj w/ Free Float • Seat Pivots from 0° to 6° Forward • Rated for 300 lbs 	<p>WIDTH: 25.0</p> <p>DEPTH: 26.0</p> <p>HEIGHT: 39.0-43.5</p> <p>SEAT WIDTH: 20.5</p> <p>SEAT DEPTH: 19.0</p> <p>BACK HEIGHT: 18.5-23.0</p> <p>BACK WIDTH: 18.5</p> <p>COM: 1.6 YD</p> <p>COL: 20.0 SQ FT</p> <p>WEIGHT: 52.0 LB</p>	<ul style="list-style-type: none"> C7 STD C6S \$35 		
A/COM	B	C	D	E	F	G	L3/COL	L4	L5																																																																																
700	755	790	845	905	970	1040	850	885	1090																																																																																
785	840	875	930	990	1055	1125	935	970	1175																																																																																
805	860	895	950	1010	1075	1145	955	990	1195																																																																																
800	855	890	945	1005	1070	1140	950	985	1190																																																																																
900	955	990	1045	1105	1170	1240	1050	1085	1290																																																																																
805	860	895	950	1010	1075	1145	955	990	1195																																																																																
825	880	915	970	1030	1095	1165	975	1010	1215																																																																																
2900	GT	GUEST Well suited for guest seating. Comes standard with non-marring glides. A20 Black powder coat A21 Chrome	<ul style="list-style-type: none"> A20 A21 	<table border="1"> <thead> <tr> <th>A/COM</th> <th>B</th> <th>C</th> <th>D</th> <th>E</th> <th>F</th> <th>G</th> <th>L3/COL</th> <th>L4</th> <th>L5</th> </tr> </thead> <tbody> <tr><td>650</td><td>705</td><td>740</td><td>795</td><td>855</td><td>920</td><td>990</td><td>800</td><td>900</td><td>1040</td></tr> <tr><td>650</td><td>705</td><td>740</td><td>795</td><td>855</td><td>920</td><td>990</td><td>800</td><td>900</td><td>1040</td></tr> </tbody> </table>	A/COM	B	C	D	E	F	G	L3/COL	L4	L5	650	705	740	795	855	920	990	800	900	1040	650	705	740	795	855	920	990	800	900	1040	<ul style="list-style-type: none"> • Cantilever Frame Design • Non-Marring Floor Glides • Rated for 250 lbs 	<p>WIDTH: 24.0</p> <p>DEPTH: 26.0</p> <p>HEIGHT: 39.0</p> <p>SEAT WIDTH: 20.5</p> <p>SEAT DEPTH: 19.0</p> <p>BACK HEIGHT: 18.0</p> <p>BACK WIDTH: 18.5</p> <p>COM: 1.6 YD</p> <p>COL: 20.0 SQ FT</p> <p>WEIGHT: 49.0 LB</p>	<ul style="list-style-type: none"> BA1 DEDUCT \$50 BA9 DEDUCT \$50 																																																				
A/COM	B	C	D	E	F	G	L3/COL	L4	L5																																																																																
650	705	740	795	855	920	990	800	900	1040																																																																																
650	705	740	795	855	920	990	800	900	1040																																																																																

SHIPS FULLY ASSEMBLED EITHER AC OR AB

cortina

simple, straightforward ergonomics and functionality

HIGH-BACK

GSA SIN # 711-18

- Task, conference and executive seating
- Aluminum base standard
- Warranted up to 250 lbs with S2, GT
- Warranted up to 300 lbs with M1, Y2
- CAL TB 133 Fire Code approved



CREATING CORTINA MODEL NUMBER

MODEL NUMBER CONTROL ARMS GRADE CASTERS PACKAGING OPTIONS

2 9 1 0 - [] [] - A [] [] - [] [] - C [] [] - [] [] [] [] - [] [] [] []

* FOR ARMLESS CODE USE A00 * GT MODELS DO NOT HAVE A CASTER CODE

PACKAGING NOTES

CODE	DESCRIPTION	LIST UPCHARGE
AB	ASSEMBLED IN BAG FOR WILL CALL	\$0
BAC	BACK ASSEMBLED IN CARTON	\$40

MODEL CONTROL DESCRIPTION

ARM FABRIC/LEATHER

	A/COM	B	C	D	E	F	G	L3/COL	L4	L5
ARMLESS	650	705	740	795	860	930	1005	820	900	1100
A8B / A8S	735	790	825	880	945	1015	1090	905	985	1185
A9B / A9S	755	810	845	900	965	1035	1110	925	1005	1205
A16	750	805	840	895	960	1030	1105	920	1000	1200
A19	850	905	940	995	1060	1130	1205	1020	1100	1300
A36	755	810	845	900	965	1035	1110	925	1005	1205
A37	775	830	865	920	985	1055	1130	945	1025	1225

SEAT SLIDER (SS) - NOT AVAILABLE

FEATURES

- Pneumatic Seat Height Adjustment
- Tilt Tension Control
- Seat and Back Tilt as a Unit
- Upright Position Tilt Lock
- Rated for 250 lbs

DIMENSIONS

WIDTH: 25.0
 DEPTH: 25.0
 HEIGHT: 47.0-51.5
 SEAT WIDTH: 20.5
 SEAT DEPTH: 19.0
 SEAT HEIGHT: 18.0-22.5
 BACK WIDTH: 18.5
 BACK HEIGHT: 29.0
 COM: 1.7 YD
 COL: 23.0 SQ FT
 WEIGHT: 48.0 LB

ARM OPTIONS

A9B/S
\$105

A16
\$100

A19
\$200

A8 2-Way 2-Way Height Adjustable Arm
 A8B - Black, A8S - Silver
 A9 4-Way Adjustable Arm
 A9B - Black, A9S - Silver

Black Soft Touch C-Shape Arm
 Polished Aluminum C-Shape Arm

MODEL CONTROL DESCRIPTION

ARM FABRIC/LEATHER

	A/COM	B	C	D	E	F	G	L3/COL	L4	L5
ARMLESS	730	785	820	875	940	1010	1085	900	950	1180
A8B / A8S	815	870	905	960	1025	1095	1170	985	1035	1265
A9B / A9S	835	890	925	980	1045	1115	1190	1005	1055	1285
A16	830	885	920	975	1040	1110	1185	1000	1050	1280
A19	930	985	1020	1075	1140	1210	1285	1100	1150	1380
A36	835	890	925	980	1045	1115	1190	1005	1055	1285
A37	855	910	945	1000	1065	1135	1210	1025	1075	1305

SEAT SLIDER (SS) - NOT AVAILABLE

- Pneumatic Seat Height Adjustment
- Back and Seat Tilt in 2:1 ratio
- 4 Locking Positions
- Safety Tilt Release
- Reduced Rise of Front of Seat
- Synchro Control
- Side Tension Adjustment
- Rated for 300 lbs

WIDTH: 25.0
 DEPTH: 25.0
 HEIGHT: 47.0-51.5
 SEAT WIDTH: 20.5
 SEAT DEPTH: 19.0
 SEAT HEIGHT: 18.0-22.5
 BACK WIDTH: 18.5
 BACK HEIGHT: 29.0
 COM: 1.7 YD
 COL: 34.0 SQ FT
 WEIGHT: 53.0 LB

CASTER OPTIONS

C7
STD

C6S
\$35

Standard w/ BA19 Base
 60mm Hoodless Casters

60mm Hoodless Hard Floor Casters

MODEL CONTROL DESCRIPTION

ARM FABRIC/LEATHER

	A/COM	B	C	D	E	F	G	L3/COL	L4	L5
ARMLESS	750	805	840	895	960	1030	1105	920	970	1200
A8B / A8S	835	890	925	980	1045	1115	1190	1005	1055	1285
A9B / A9S	855	910	945	1000	1065	1135	1210	1025	1075	1305
A16	850	905	940	995	1060	1130	1205	1020	1070	1300
A19	950	1005	1040	1095	1160	1230	1305	1120	1170	1400
A36	855	910	945	1000	1065	1135	1210	1025	1075	1305
A37	875	930	965	1020	1085	1155	1230	1045	1095	1325

SEAT SLIDER (SS) - NOT AVAILABLE

- Pneumatic Seat Height Adjustment
- Tilt Tension Control
- Seat and Back Tilt as a Unit
- Infinite Tilt Position Lock
- Infinite Back Angle Adj w/ Free Float
- Seat Pivots from 0° to 6° Forward
- Rated for 300 lbs

WIDTH: 25.0
 DEPTH: 25.0
 HEIGHT: 47.0-51.5
 SEAT WIDTH: 20.5
 SEAT DEPTH: 19.0
 SEAT HEIGHT: 18.5-23.0
 BACK WIDTH: 18.5
 BACK HEIGHT: 29.0
 COM: 1.7 YD
 COL: 23.0 SQ FT
 WEIGHT: 56.0 LB

ADDITIONAL OPTIONS

BA1
DEDUCT \$50

BA9
DEDUCT \$50

27" Black Nylon Spider Base comes standard w/ C1 50mm Hooded Casters

26" High Profile Black Nylon Base comes standard w/ C6 65mm Hoodless Casters

cosmo

contemporary style, elegance, and comfort

GSA SIN # 711-18

- Task, executive and conference seating
- Back styles include: knit, mesh and upholstered
- Aluminum base standard
- Warranted up to 250 lbs with GT
- Warranted up to 300 lbs with X2
- CAL TB 133 Fire Code approved
- Seat Slider standard with X2



CREATING COSMO MODEL NUMBER

MODEL NUMBER CONTROL ARMS BACK TYPE MESH COLOR GRADE CASTERS PACKAGING OPTIONS
3 2 0 - **A** - **M B** - **M** - **-** - **-** - **-** - **-**

* GT MODELS DO NOT HAVE A CASTER CODE

PACKAGING NOTES

CODE	DESCRIPTION	LIST UPCHARGE
AB	ASSEMBLED IN BAG FOR WILL CALL	\$0
BAC	BACK ASSEMBLED IN CARTON	\$0

NEW MESH BACK - MB

MODEL	CONTROL	DESCRIPTION	ARM	FABRIC/LEATHER	FEATURES	DIMENSIONS
3250	X2	MID-BACK DYNAMIC SYNCHRO TILT CONTROL Use for a variety of general office task seating, including private office and conference room seating.	A31	A/COM 725 B 755 C 775 D 805 E 840 F 880 G 920 L3/COL 765 L4 835 L5 920	<ul style="list-style-type: none"> • Pneumatic Seat Height Adjustment • Side Adjustable Tilt Tension Control • Back and Seat Tilt in 2.6:1 Ratio • 26° Tilt of Back, 10° Seat Tilt • 11 Locking Positions • 2 Position Forward Seat Angle Adj • Standard Seat Slider Adds 3" Adj • Rated for 300 lbs 	WIDTH: 26.0-28.5 DEPTH: 25.0 HEIGHT: 40.0-45.5 SEAT WIDTH: 20.0 SEAT DEPTH: 17.5-20.0 SEAT HEIGHT: 17.5-22.0 BACK WIDTH: 19.5 BACK HEIGHT: 22.0 COM: 0.8 YDS COL: 10.0 SQ FT WEIGHT: 42.0 LB
			A38	735 765 785 815 850 890 930 775 845 930		
3260	X2	HIGH-BACK DYNAMIC SYNCHRO TILT CONTROL Use for a variety of general office task seating, including private office and conference room seating.	A31	A/COM 825 B 855 C 875 D 905 E 940 F 980 G 1020 L3/COL 865 L4 935 L5 1020	<ul style="list-style-type: none"> • Pneumatic Seat Height Adjustment • Side Adjustable Tilt Tension Control • Back and Seat Tilt in 2.6:1 Ratio • 26° Tilt of Back, 10° Seat Tilt • 11 Locking Positions • 2 Position Forward Seat Angle Adj • Standard Seat Slider Adds 3" Adj • Rated for 300 lbs 	WIDTH: 26.0-28.5 DEPTH: 25.0 HEIGHT: 47.0-51.5 SEAT WIDTH: 20.0 SEAT DEPTH: 17.5-20.0 SEAT HEIGHT: 17.5-22.0 BACK WIDTH: 19.5 BACK HEIGHT: 29.0 COM: 0.8 YDS COL: 10.0 SQ FT WEIGHT: 44.0 LB
			A38	835 865 885 915 950 990 1030 875 945 1030		
3250	GT	GUEST CHAIR Well suited for guest seating. Comes standard with non-marring glides.	A33	A/COM 625 B 655 C 675 D 705 E 740 F 780 G 820 L3/COL 665 L4 735 L5 820	<ul style="list-style-type: none"> • Cantilever Frame Design • Non-Marring Floor Glides • Rated for 250 lbs 	WIDTH: 26.0 DEPTH: 28.0 HEIGHT: 39.0 SEAT WIDTH: 20.0 SEAT DEPTH: 18.0 SEAT HEIGHT: 17.5 BACK WIDTH: 19.5 BACK HEIGHT: 22.0 COM: 0.8 YDS COL: 10.0 SQ FT WEIGHT: 33.0 LB

SHIPS FULLY ASSEMBLED EITHER AC OR AB

ARM OPTIONS

A31	A33	A38

CASTER OPTIONS

C6 STD	C6S \$35

ADDITIONAL OPTIONS

STRIPE MESH COLORS

BLACK / GRAY MS2	BLACK / GREEN MS4	BLACK / RED MS5	BLACK / BLUE MS6
---------------------	----------------------	--------------------	---------------------

MESH COLORS

BLACK M11	GRAY M12	SILVER M13
GREEN M14	RED M15	BLUE M16

cosmo

contemporary style, elegance, and comfort

GSA SIN # 711-18

- Task, executive and conference seating
- Back styles include: knit, mesh and upholstered
- Aluminum base standard
- Warranted up to 250 lbs with GT
- Warranted up to 300 lbs with X2
- CAL TB 133 Fire Code approved
- Seat Slider standard with X2



CREATING COSMO MODEL NUMBER

MODEL NUMBER CONTROL ARMS BACK TYPE GRADE CASTERS PACKAGING OPTIONS

3 2 - X 2 - A - U B - - - - -

* GT MODELS DO NOT HAVE A CASTER CODE

PACKAGING NOTES

CODE	DESCRIPTION	LIST UPCHARGE
AB	ASSEMBLED IN BAG FOR WILL CALL	\$0
BAC	BACK ASSEMBLED IN CARTON	\$0

NEW THIN UPHOLSTERED BACK - UB

MODEL	CONTROL	DESCRIPTION	ARM	FABRIC/LEATHER	FEATURES	DIMENSIONS												
<p>NEW MODEL</p> <p>3220</p>	X2	<p>MID-BACK DYNAMIC SYNCHRO TILT CONTROL</p> <p>Use for a variety of general office task seating, including private office and conference room seating.</p>	A31 A38	<table border="1"> <thead> <tr> <th>A*</th> <th>L3/COL</th> <th>L4</th> <th>L5</th> </tr> </thead> <tbody> <tr> <td>785</td> <td>825</td> <td>985</td> <td>1285</td> </tr> <tr> <td>795</td> <td>835</td> <td>995</td> <td>1295</td> </tr> </tbody> </table>	A*	L3/COL	L4	L5	785	825	985	1285	795	835	995	1295	<ul style="list-style-type: none"> • Pneumatic Seat Height Adjustment • Side Adjustable Tilt Tension Control • Back and Seat Tilt in 2.6:1 Ratio • 26° Tilt of Back, 10° Seat Tilt • 11 Locking Positions • 2 Position Forward Seat Angle Adj • Standard Seat Slider Adds 3" Adj • Standard with Heavy Duty Hard Floor Casters • Rated for 300 lbs 	<p>WIDTH: 26-28.5</p> <p>DEPTH: 25.0</p> <p>HEIGHT: 40 - 44.5</p> <p>SEAT WIDTH: 20.0</p> <p>SEAT DEPTH: 17.5-20</p> <p>SEAT HEIGHT: 17.5 - 22</p> <p>BACK WIDTH: 19.5</p> <p>BACK HEIGHT: 22.0</p> <p>COM: 1 YD</p> <p>COL: 7 SQ FT</p> <p>WEIGHT: 42 LB</p>
A*	L3/COL	L4	L5															
785	825	985	1285															
795	835	995	1295															
<p>NEW MODEL</p> <p>3230</p>	X2	<p>HIGH-BACK DYNAMIC SYNCHRO TILT CONTROL</p> <p>Use for a variety of general office task seating, including private office and conference room seating.</p>	A31 A38	<table border="1"> <thead> <tr> <th>A*</th> <th>L3/COL</th> <th>L4</th> <th>L5</th> </tr> </thead> <tbody> <tr> <td>885</td> <td>925</td> <td>1085</td> <td>1385</td> </tr> <tr> <td>895</td> <td>935</td> <td>1095</td> <td>1395</td> </tr> </tbody> </table>	A*	L3/COL	L4	L5	885	925	1085	1385	895	935	1095	1395	<ul style="list-style-type: none"> • Pneumatic Seat Height Adjustment • Side Adjustable Tilt Tension Control • Back and Seat Tilt in 2.6:1 Ratio • 26° Tilt of Back, 10° Seat Tilt • 11 Locking Positions • 2 Position Forward Seat Angle Adj • Standard Seat Slider Adds 3" Adj • Standard with Heavy Duty Hard Floor Casters • Rated for 300 lbs 	<p>WIDTH: 26-28.5</p> <p>DEPTH: 25.0</p> <p>HEIGHT: 47.0 - 51.5</p> <p>SEAT WIDTH: 20.0</p> <p>SEAT DEPTH: 17.5-20</p> <p>SEAT HEIGHT: 17.5 - 22</p> <p>BACK WIDTH: 19.5</p> <p>BACK HEIGHT: 29.0</p> <p>COM: 1 YD</p> <p>COL: 7 SQ FT</p> <p>WEIGHT: 44 LB</p>
A*	L3/COL	L4	L5															
885	925	1085	1385															
895	935	1095	1395															
<p>NEW MODEL</p> <p>3220</p>	GT	<p>GUEST CHAIR</p> <p>Well suited for guest seating. Comes standard with non-marring glides.</p>	A33	<table border="1"> <thead> <tr> <th>A*</th> <th>L3/COL</th> <th>L4</th> <th>L5</th> </tr> </thead> <tbody> <tr> <td>685</td> <td>725</td> <td>885</td> <td>1185</td> </tr> </tbody> </table>	A*	L3/COL	L4	L5	685	725	885	1185	<ul style="list-style-type: none"> • Cantilever Frame Design • Non-Marring Floor Glides • Rated for 250 lbs 	<p>WIDTH: 26.0</p> <p>DEPTH: 28.0</p> <p>HEIGHT: 39.0</p> <p>SEAT WIDTH: 20.0</p> <p>SEAT DEPTH: 18.0</p> <p>SEAT HEIGHT: 17.5</p> <p>BACK WIDTH: 19.5</p> <p>BACK HEIGHT: 22.0</p> <p>COM: 1 YD</p> <p>COL: 7 SQ FT</p> <p>WEIGHT: 33 LB</p>				
A*	L3/COL	L4	L5															
685	725	885	1185															

SHIPS FULLY ASSEMBLED EITHER AC OR AB

*GRADE A POLY (POLYURETHANE)

ARM OPTIONS



A31
Black Soft Touch Fixed Cantilever Arm

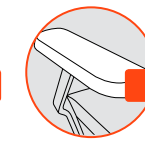

A33
Fixed Arm with Soft Polyurethane Pad For Guest Model Only

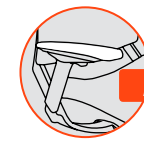

A38
2-Way Height Adjustable Arm

CASTER OPTIONS

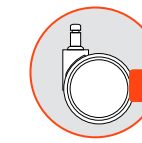

C6 STD
Standard 60mm Hoodless Casters

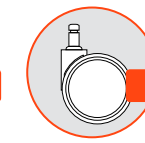

C6S \$35
60mm Hoodless Hard Floor Casters

ADDITIONAL OPTIONS

cosmo

contemporary style, elegance, and comfort

GSA SIN # 711-18

- Task, executive and conference seating
- Back styles include: knit, mesh and upholstered
- Aluminum base standard
- Warranted up to 250 lbs with GT
- Warranted up to 300 lbs with X2
- Seat Slider standard with X2



CREATING COSMO MODEL NUMBER

MODEL NUMBER CONTROL ARMS BACK TYPE GRADE CASTERS PACKAGING OPTIONS

3 2 0 - A U B - C - - - -

*GT MODEL'S DO NOT HAVE A CASTER CODE

PACKAGING NOTES

CODE	DESCRIPTION	LIST UPCHARGE
AB	ASSEMBLED IN BAG FOR WILL CALL	\$0
BAC	BACK ASSEMBLED IN CARTON	\$0

UPHOLSTERED BACK - UB

MODEL	CONTROL	DESCRIPTION	ARM	LEATHER	L3/COL	L4	L5	FEATURES	DIMENSIONS
3200	X2	MID-BACK DYNAMIC SYNCHRO TILT CONTROL Use for a variety of general office task seating, including private office and conference room seating.	A31 A38		910 920	1050 1060	1320 1330	<ul style="list-style-type: none"> • Pneumatic Seat Height Adjustment • Side Adjustable Tilt Tension Control • Back and Seat Tilt in 2.6:1 Ratio • 26° Tilt of Back, 10° Seat Tilt • 11 Locking Positions • 2 Position Forward Seat Angle Adj • Standard Seat Slider Adds 3" Adj • Standard with Heavy Duty Hard Floor Casters • Rated for 300 lbs 	WIDTH: 26.0-28.5 DEPTH: 25.0 HEIGHT: 40.0-45.5 SEAT WIDTH: 20.0 SEAT DEPTH: 17.0-19.5 SEAT HEIGHT: 18.0-22.5 BACK WIDTH: 20.0 BACK HEIGHT: 22.0 COL: 28.0 SQ FT WEIGHT: 48.0 LB
3210	X2	HIGH-BACK DYNAMIC SYNCHRO TILT CONTROL Use for a variety of general office task seating, including private office and conference room seating.	A31 A38		1050 1060	1255 1265	1560 1570	<ul style="list-style-type: none"> • Pneumatic Seat Height Adjustment • Side Adjustable Tilt Tension Control • Back and Seat Tilt in 2.6:1 Ratio • 26° Tilt of Back, 10° Seat Tilt • 11 Locking Positions • 2 Position Forward Seat Angle Adj • Standard Seat Slider Adds 3" Adj • Standard with Heavy Duty Hard Floor Casters • 4 Way Adjustable Headrest • Rated for 300 lbs 	WIDTH: 26.0-28.5 DEPTH: 25.0 HEIGHT: 47.0-51.5 SEAT WIDTH: 20.0 SEAT DEPTH: 16.0-18.5 SEAT HEIGHT: 17.5-22.0 BACK WIDTH: 20.0 BACK HEIGHT: 29.0 COL: 28.0 SQ FT WEIGHT: 55.0 LB
3200	GT	GUEST CHAIR Well suited for guest seating. Comes standard with non-marring glides.	A33		760	900	1170	<ul style="list-style-type: none"> • Cantilever Frame Design • Non-Marring Floor Glides • Rated for 250 lbs 	WIDTH: 26.0 DEPTH: 28.0 HEIGHT: 39.0 SEAT WIDTH: 20.0 SEAT DEPTH: 16.5 SEAT HEIGHT: 17.5 BACK WIDTH: 20.0 BACK HEIGHT: 22.0 COL: 28.0 SQ FT WEIGHT: 38.0 LB

SHIPS FULLY ASSEMBLED EITHER AC OR AB

ARM OPTIONS

A31

Black Soft Touch Fixed Cantilever Arm

A33

Fixed Arm with Soft Polyurethane Pad For Guest Model Only

A38

2-Way Height Adjustable Arm

CASTER OPTIONS

C6

STD

Standard 60mm Hoodless Casters

C6S

\$35

60mm Hoodless Hard Floor Casters

ADDITIONAL OPTIONS

cydia

organic design meets ergonomic excellence

GSA SIN # 711-18

- Stool, Conference, and Lounge seating
- Choice of 3 metal frame colors and 14 mesh colors
- Warranted up to 250 lbs
- CAL TB 133 Fire Code approved



CREATING CYDIA MODEL NUMBER

MODEL NUMBER CONTROL ARMS ACCENT COLOR UPHOLSTERY MESH COLOR CASTERS PACKAGING OPTIONS

3 3 0 - - A - P A - A M - M - C 6 - - - -

* FOR ARMLESS CODE USE A00

PACKAGING NOTES

CODE	DESCRIPTION	LIST UPCHARGE
AB	ASSEMBLED IN BAG FOR WILL CALL	\$0
BAC	BACK ASSEMBLED IN CARTON	\$0

ALL MESH

MODEL	CONTROL	DESCRIPTION	MESH	ARM	MESH	FEATURES	DIMENSIONS
3300	S3	MID-SIZE SWIVEL TILT CONTROL Use for a variety of general office seating, including private office and conference room seating.	M1 M1 M1 M3 M3 M3	ARMLESS A34 A35 ARMLESS A34 A35	M 600 675 700 625 700 725	<ul style="list-style-type: none"> • Pneumatic Seat Height Adjustment • Tilt Tension Control • Seat and Back Tilt as a Unit • Upright Position Tilt Lock • Rated for 250 lbs 	WIDTH: 28.0 DEPTH: 27.5 HEIGHT: 34.0-36.75 SEAT WIDTH: 19.0 SEAT DEPTH: 16.0 SEAT HEIGHT: 16.5-21.0 BACK WIDTH: 18.0 BACK HEIGHT: 19.5 WEIGHT: 36.0 LB
3300	K3	MID-SIZE KNEE TILT CONTROL Ultimate seating comfort suited for the executive or manager. Allows for full range of movement with sharp, simple look.	M1 M1 M1 M3 M3 M3	ARMLESS A34 A35 ARMLESS A34 A35	M 700 775 800 725 800 825	<ul style="list-style-type: none"> • Pneumatic Seat Height Adjustment • Side Activated Tilt Tension Control • Seat and Back Tilt as a unit • 3 Locking Positions • Forward Pitch Seat Lock • Reduced Rise of Front of Seat • Rated for 250 lbs 	WIDTH: 28.0 DEPTH: 27.5 HEIGHT: 36.0-40.75 SEAT WIDTH: 19.0 SEAT DEPTH: 16.0 SEAT HEIGHT: 18.0-22.5 BACK WIDTH: 18.0 BACK HEIGHT: 19.5 WEIGHT: 43.0 LB
3310	S3	FULL-SIZE SWIVEL TILT CONTROL Use for a variety of general office seating, including private office and conference room seating.	M1 M1 M1 M3 M3 M3	ARMLESS A34 A35 ARMLESS A34 A35	M 650 725 750 685 760 785	<ul style="list-style-type: none"> • Pneumatic Seat Height Adjustment • Tilt Tension Control • Seat and Back Tilt as a Unit • Upright Position Tilt Lock • Rated for 250 lbs 	WIDTH: 28.0 DEPTH: 27.5 HEIGHT: 39.5-43.5 SEAT WIDTH: 19.0 SEAT DEPTH: 17.0 SEAT HEIGHT: 16.5-21.0 BACK WIDTH: 18.0 BACK HEIGHT: 23.375 WEIGHT: 39.0 LB
3310	K3	FULL-SIZE KNEE TILT CONTROL Ultimate seating comfort suited for the executive or manager. Allows for full range of movement with sharp, simple look.	M1 M1 M1 M3 M3 M3	ARMLESS A34 A35 ARMLESS A34 A35	M 750 825 850 785 860 885	<ul style="list-style-type: none"> • Pneumatic Seat Height Adjustment • Side Activated Tilt Tension Control • Seat and Back Tilt as a unit • 3 Locking Positions • Forward Pitch Seat Lock • Reduced Rise of Front of Seat • Height Lumbar Adjustment • Rated for 250 lbs 	WIDTH: 28.0 DEPTH: 27.5 HEIGHT: 41.5-45.5 SEAT WIDTH: 19.0 SEAT DEPTH: 17.0 SEAT HEIGHT: 18.0-22.5 BACK WIDTH: 18.0 BACK HEIGHT: 23.375 WEIGHT: 46.0 LB

ARM OPTIONS

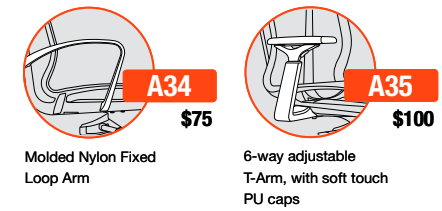

CASTER OPTIONS



ADDITIONAL OPTIONS

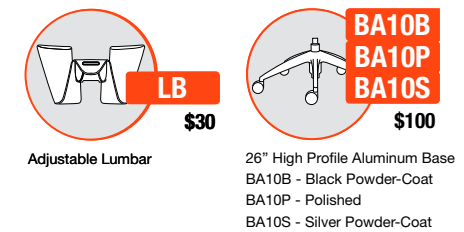

ACCENT COLORS

BLACK PBA	GRAY PGA	WHITE PWA
--------------	-------------	--------------

MESH COLORS

BLACK M11	GRAY M12	SILVER M13	GREEN M14	RED M15	BLUE M16
GRAPHITE M31	SLATE M32	SNOW M33	SAGE M34		
CARDINAL M35	ROYAL M36	TANGERINE M37	PLUM M38		

cydia

organic design meets ergonomic excellence

GSA SIN # 711-18

- Stool, Conference, and Lounge seating
- Choice of 3 frame metal colors and 14 mesh colors
- Warranted up to 250 lbs
- CAL TB 133 Fire Code approved



CREATING CYDIA MODEL NUMBER

MODEL NUMBER	CONTROL	ACCENT COLOR	UPHOLSTERY	MESH COLOR	GRADE	PACKAGING	OPTIONS
3300	S3	P	A	A	M	M	

* FOR ARMLESS CODE USE A00

PACKAGING NOTES

CODE	DESCRIPTION	LIST UPCHARGE
AB	ASSEMBLED IN BAG FOR WILL CALL	\$0
BAC	BACK ASSEMBLED IN CARTON	\$0

ALL MESH - STOOLS

MODEL	CONTROL	DESCRIPTION	MESH	ARM	MESH
3306	S3	10" TRAVEL HIGH STOOL SWIVEL TILT CONTROL Use for work surfaces up to 42 inches high.	M1	ARMLESS	M
			M1	A34	725
			M1	A35	800
			M3	ARMLESS	825
			M3	A34	750
			M3	A35	825

MODEL	CONTROL	DESCRIPTION	MESH	ARM	MESH
3308	S3	8" TRAVEL LOW STOOL SWIVEL TILT CONTROL Use for work surfaces up to 36 inches high.	M1	ARMLESS	M
			M1	A34	725
			M1	A35	800
			M3	ARMLESS	825
			M3	A34	750
			M3	A35	825

FEATURES

- Pneumatic Seat Height Adjustment
- Tilt Tension Control
- Seat and Back Tilt as a Unit
- Upright Position Tilt Lock
- Knobless Height Adjustable Footring
- Rated for 250 lbs

DIMENSIONS

WIDTH: 28.0
DEPTH: 27.5
HEIGHT: 43.5-53.5
SEAT WIDTH: 19.0
SEAT DEPTH: 16.0
SEAT HEIGHT: 26.0-36.0
BACK WIDTH: 18.0
BACK HEIGHT: 19.5
WEIGHT: 42.0 LB

ARM OPTIONS



Molded Nylon Fixed Loop Arm



6-way adjustable T-Arm, with soft touch PU caps

CASTER OPTIONS

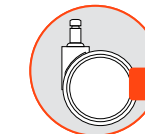

Standard 60mm Hoodless Casters

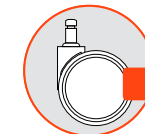

60mm Hoodless Hard Floor Casters

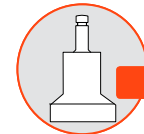

Stationary Base Glides for 5 Star Base

ADDITIONAL OPTIONS

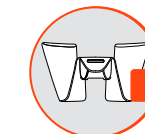

Adjustable Lumbar



26" High Profile Aluminum Base
 BA10B - Black Powder-Coat
 BA10P - Polished
 BA10S - Silver Powder-Coat

ACCENT COLORS

BLACK PBA	GRAY PGA	WHITE PWA
--------------	-------------	--------------

MESH COLORS

	BLACK M11	GRAY M12	SILVER M13	GREEN M14	RED M15	BLUE M16
M1	GRAPHITE M31	SLATE M32	SNOW M33	SAGE M34		
M3	CARDINAL M35	ROYAL M36	TANGERINE M37	PLUM M38		

cydia

organic design meets ergonomic excellence

GSA SIN # 711-18

- Multi-Purpose Guest Seating
- Choice of 3 metal frame colors and 14 mesh colors
- Warranted up to 250 lbs
- CAL TB 133 Fire Code approved



CREATING CYDIA MODEL NUMBER

MODEL NUMBER CONTROL ACCENT COLOR FRAME COLOR UPHOLSTERY MESH COLOR GRADE PACKAGING OPTIONS

3 3 1 0 - G T - P A - - - A M - M - - M - - - - -

* FOR ARMLESS CODE USE A00

FRAME COLORS

CODE	DESCRIPTION
BF	BLACK
GF	GRAY
WF	WHITE

PACKAGING NOTES

CODE	DESCRIPTION	LIST UPCHARGE
AB	ASSEMBLED IN BAG FOR WILL CALL	\$0
BAC	BACK ASSEMBLED IN CARTON	\$0

ALL MESH - GUEST

MODEL	CONTROL	DESCRIPTION	MESH	ARM	MESH	FEATURES	DIMENSIONS
3300	GT	MID-SIZE GUEST Well suited for guest seating.	M1 M3	SWA SWA	M 500 525	<ul style="list-style-type: none"> • Non-Marring Floor Glides • Wall Saver Back Legs • Black, Silver or White Metal Frame • Rated for 250 lbs 	WIDTH: 23.75 DEPTH: 26.5 HEIGHT: 35.0 SEAT WIDTH: 19.0 SEAT DEPTH: 16.0 SEAT HEIGHT: 18.5 BACK WIDTH: 18.0 BACK HEIGHT: 19.5 WEIGHT: 25.0 LB
3310	GT	FULL-SIZE GUEST Well suited for guest seating.	M1 M3	SWA SWA	M 550 585	<ul style="list-style-type: none"> • Non-Marring Floor Glides • Wall Saver Back Legs • Black, Silver or White Metal Frame • Rated for 250 lbs 	WIDTH: 23.75 DEPTH: 26.5 HEIGHT: 39.0 SEAT WIDTH: 19.0 SEAT DEPTH: 17.0 SEAT HEIGHT: 18.5 BACK WIDTH: 18.0 BACK HEIGHT: 23.375 WEIGHT: 28.0 LB

SWA - STANDARD WITH ARMS

SWA - STANDARD WITH ARMS

ADDITIONAL OPTIONS



Adjustable Lumbar

LB
\$30

ACCENT COLORS

BLACK PBA	GRAY PGA	WHITE PWA
--------------	-------------	--------------

MESH COLORS

	BLACK M11	GRAY M12	SILVER M13	GREEN M14	RED M15	BLUE M16
M1	GRAPHITE M31	SLATE M32	SNOW M33	SAGE M34		
M3	CARDINAL M35	ROYAL M36	TANGERINE M37	PLUM M38		

cydia

organic design meets ergonomic excellence

GSA SIN # 711-18

- Relaxed angle Guest Seating with Ottoman
- Choice of 3 frame colors and 14 mesh colors
- Polished aluminum base
- Self return base mount on both chair and ottoman
- Warranted up to 250 lbs
- CAL TB 133 Fire Code approved



CREATING CYDIA MODEL NUMBER

MODEL NUMBER CONTROL ARMS ACCENT COLOR MESH COLOR GRADE PACKAGING OPTIONS

3 3 1 - - A 3 4 - P A - M - M - - -

* FOR ARMLESS CODE USE A00

PACKAGING NOTES

CODE	DESCRIPTION	LIST UPCHARGE
AB	ASSEMBLED IN BAG FOR WILL CALL	\$0
BAC	BACK ASSEMBLED IN CARTON	\$0

NEW ALL MESH - LOUNGE & OTTOMAN

MODEL	CONTROL	DESCRIPTION	MESH	ARM	MESH	FEATURES	DIMENSIONS
3315	LG	FULL-SIZE LOUNGE Full scale lounge comfort with cool, breathable all mesh fabric at a reclining angle. Modern design addition to Lobby, Office or group areas.	M1	ARMLESS	M	<ul style="list-style-type: none"> • Fixed Height • Automatic Return-To-Center Swivel • 11 Degree Fixed Seat Angle • Polished Aluminum Base • Easy Gliding, Non-Marring Feet • Extra-Wide Scale • Recycled/Recyclable Cast Aluminum Legs • Rated for 250 lbs 	WIDTH: 25.5 DEPTH: 34.0 HEIGHT: 35.5 SEAT WIDTH: 20.0 SEAT DEPTH: 17.0 SEAT HEIGHT: 18.5 BACK WIDTH: 20.0 BACK HEIGHT: 18.5 WEIGHT: 32.0 LB
			M1	A34	660		
			M3	ARMLESS	735		
			M3	A34	705		
3316	OT	OTTOMAN Ultimate comfort compliment to Lounge chair.	M1		M	<ul style="list-style-type: none"> • Fixed Height • Automatic Return-To-Center Swivel • Polished Aluminum Base • Easy Gliding, Non-Marring Feet • Recycled/Recyclable Cast Aluminum Legs • Rated for 250 lbs 	WIDTH: 21.5 DEPTH: 21.5 HEIGHT: 18.0 WEIGHT: 13.0 LB
			M3		525		
					550		

ARM OPTIONS

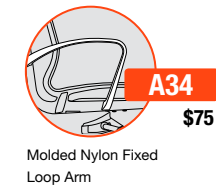

ACCENT COLORS

BLACK PBF	GRAY PGF	WHITE PWF
--------------	-------------	--------------

MESH COLORS

	BLACK M11	GRAY M12	SILVER M13	GREEN M14	RED M15	BLUE M16
M1	GRAPHITE M31	SLATE M32	SNOW M33	SAGE M34		
M3	CARDINAL M35	ROYAL M36	TANGERINE M37	PLUM M38		

cydia

organic design meets ergonomic excellence

GSA SIN # 711-18

- Task Stool, Conference, and Lounge seating
- Choice of 3 frame colors and 14 mesh colors
- Warranted up to 250 lbs
- CAL TB 133 Fire Code approved



CREATING CYDIA MODEL NUMBER

MODEL NUMBER CONTROL ARMS ACCENT COLOR UPHOLSTERY MESH COLOR GRADE CASTERS PACKAGING OPTIONS

3 3 0 0 0 - 0 0 - A 0 0 - P 0 A - U P - M 0 0 - 0 - C 6 0 0 - 0 0 0 - 0 0 0

* FOR ARMLESS CODE USE A00

PACKAGING NOTES

CODE	DESCRIPTION	LIST UPCHARGE
AB	ASSEMBLED IN BAG FOR WILL CALL	\$0
BAC	BACK ASSEMBLED IN CARTON	\$0

NEW FULLY UPHOLSTERED

MODEL	CONTROL	DESCRIPTION	MESH	ARM	MESH/FABRIC
3300	S3	MID-SIZE SWIVEL TILT CONTROL Use for a variety of general office seating, including private office and conference room seating.	M1	ARMLESS	A/COM: 750, B: 785, C: 805, D: 840, E: 875, F: 915, G: 960
			M1	A34	825, 860, 880, 915, 950, 990, 1035
			M1	A35	850, 885, 905, 940, 975, 1015, 1060
			M3	ARMLESS	775, 810, 830, 865, 900, 940, 985
			M3	A34	850, 885, 905, 940, 975, 1015, 1060
			M3	A35	875, 910, 930, 965, 1000, 1040, 1085

- #### FEATURES
- Pneumatic Seat Height Adjustment
 - Tilt Tension Control
 - Seat and Back Tilt as a Unit
 - Upright Position Tilt Lock
 - Upholstered Pad Sewn to Mesh

DIMENSIONS

WIDTH: 28.0
DEPTH: 27.5
HEIGHT: 34.0-36.75
SEAT WIDTH: 19.0
SEAT DEPTH: 16.0
SEAT HEIGHT: 16.5-21.0
BACK WIDTH: 18.0
BACK HEIGHT: 19.5
COM: 2.0 YDS
COL: 12.0 SQ FT
WEIGHT: 36.0 LB

ARM OPTIONS



A34
\$75

Molded Nylon Fixed Loop Arm



A35
\$100

6-way adjustable T-Arm, with soft touch PU caps

MODEL	CONTROL	DESCRIPTION	MESH	ARM	MESH/FABRIC
3300	K3	MID-SIZE KNEE TILT CONTROL Ultimate seating comfort suited for the executive or manager. Allows for full range of movement with sharp, simple look.	M1	ARMLESS	A/COM: 850, B: 885, C: 905, D: 940, E: 975, F: 1015, G: 1060
			M1	A34	925, 960, 980, 1015, 1050, 1090, 1135
			M1	A35	950, 985, 1005, 1040, 1075, 1115, 1160
			M3	ARMLESS	875, 910, 930, 965, 1000, 1040, 1085
			M3	A34	950, 985, 1005, 1040, 1075, 1115, 1160
			M3	A35	975, 1010, 1030, 1065, 1100, 1140, 1185

- #### FEATURES
- Pneumatic Seat Height Adjustment
 - Side Activated Tilt Tension Control
 - Seat and Back Tilt as a Unit
 - 3 Locking Positions
 - Forward Pitch Seat Lock
 - Reduced Rise of Front of Seat
 - Height Lumbar Adjustment
 - Upholstered Pad Sewn to Mesh

DIMENSIONS

WIDTH: 28.0
DEPTH: 27.5
HEIGHT: 36.0-40.75
SEAT WIDTH: 19.0
SEAT DEPTH: 16.0
SEAT HEIGHT: 18.0-22.5
BACK WIDTH: 18.0
BACK HEIGHT: 19.5
COM: 2.0 YDS
COL: 12.0 SQ FT
WEIGHT: 43.0 LB

CASTER OPTIONS



C6
STD

Standard 60mm Hoodless Casters



C6S
\$35

60mm Hoodless Hard Floor Casters



G1
\$30

Stationary Base Glides for 5 Star Base

MODEL	CONTROL	DESCRIPTION	MESH	ARM	MESH/FABRIC
3310	S3	FULL-SIZE SWIVEL TILT CONTROL Use for a variety of general office seating, including private office and conference room seating.	M1	ARMLESS	A/COM: 800, B: 835, C: 855, D: 890, E: 925, F: 965, G: 1010
			M1	A34	875, 910, 930, 965, 1000, 1040, 1085
			M1	A35	900, 935, 955, 990, 1025, 1065, 1110
			M3	ARMLESS	835, 870, 890, 925, 960, 1000, 1045
			M3	A34	910, 945, 965, 1000, 1035, 1075, 1120
			M3	A35	935, 970, 990, 1025, 1060, 1100, 1145

- #### FEATURES
- Pneumatic Seat Height Adjustment
 - Tilt Tension Control
 - Seat and Back Tilt as a Unit
 - Upright Position Tilt Lock
 - Upholstered Pad Sewn Over Mesh

DIMENSIONS

WIDTH: 28.0
DEPTH: 27.5
HEIGHT: 39.5-43.5
SEAT WIDTH: 19.0
SEAT DEPTH: 17.0
SEAT HEIGHT: 16.5-21.0
BACK WIDTH: 18.0
BACK HEIGHT: 23.375
COM: 2.0 YDS
COL: 14.0 SQ FT
WEIGHT: 39.0 LB

ADDITIONAL OPTIONS



LB
\$30

Adjustable Lumbar



**BA10B
BA10P
BA10S**
\$100

26" High Profile Aluminum Base
BA10B - Black Powder-Coat
BA10P - Polished
BA10S - Silver Powder-Coat

MODEL	CONTROL	DESCRIPTION	MESH	ARM	MESH/FABRIC
3310	K3	FULL-SIZE KNEE TILT CONTROL Ultimate seating comfort suited for the executive or manager. Allows for full range of movement with sharp, simple look.	M1	ARMLESS	A/COM: 900, B: 935, C: 955, D: 990, E: 1025, F: 1065, G: 1110
			M1	A34	975, 1010, 1030, 1065, 1100, 1140, 1185
			M1	A35	1000, 1035, 1035, 1035, 1035, 1035, 1035
			M3	ARMLESS	935, 970, 990, 1025, 1060, 1100, 1145
			M3	A34	1010, 1045, 1065, 1100, 1135, 1175, 1220
			M3	A35	1035, 1070, 1090, 1125, 1160, 1200, 1245

- #### FEATURES
- Pneumatic Seat Height Adjustment
 - Side Activated Tilt Tension Control
 - Seat and Back Tilt as a Unit
 - 3 Locking Positions
 - Forward Pitch Seat Lock
 - Reduced Rise of Front of Seat
 - Height Lumbar Adjustment
 - Upholstered Pad Sewn Over Mesh

DIMENSIONS

WIDTH: 28.0
DEPTH: 27.5
HEIGHT: 41.5-45.5
SEAT WIDTH: 19.0
SEAT DEPTH: 17.0
SEAT HEIGHT: 18.0-22.5
BACK WIDTH: 18.0
BACK HEIGHT: 23.375
COM: 2.0 YDS
COL: 14.0 SQ FT
WEIGHT: 46.0 LB

ACCENT COLORS

BLACK PBA	GRAY PGA	WHITE PWA
--------------	-------------	--------------

MESH COLORS

	BLACK M11	GRAY M12	SILVER M13	GREEN M14	RED M15	BLUE M16
M1	GRAPHITE M31	SLATE M32	SNOW M33	SAGE M34		
M3	CARDINAL M35	ROYAL M36	TANGERINE M37	PLUM M38		

cydia

organic design meets ergonomic excellence

GSA SIN # 711-18

- Stool, Conference, and Lounge seating
- Choice of 3 plastic colors and 14 mesh colors
- Warranted up to 250 lbs
- CAL TB 133 Fire Code approved



CREATING CYDIA MODEL NUMBER

MODEL NUMBER CONTROL ARMS ACCENT COLOR UPHOLSTERY MESH COLOR GRADE CASTERS PACKAGING OPTION

3 3 1 0 - [] [] - A [] [] - P [] [] - U P - M [] [] - [] [] - C 6 [] [] - [] [] - [] []

* FOR ARMLESS CODE USE A00

FRAME COLORS

CODE	DESCRIPTION
BF	BLACK
GF	GRAY
WF	WHITE

PACKAGING NOTES

CODE	DESCRIPTION	LIST UPCHARGE
AB	ASSEMBLED IN BAG FOR WILL CALL	\$0
BAC	BACK ASSEMBLED IN CARTON	\$0

NEW FULLY UPHOLSTERED - STOOL

MODEL	CONTROL	DESCRIPTION	MESH	ARM	MESH/FABRIC	A/COM	B	C	D	E	F	G
3306	S3	10" TRAVEL HIGH STOOL SWIVEL TILT CONTROL Use for work surfaces up to 42 inches high.	M1	ARMLESS		875	910	930	965	1000	1040	1085
			M1	A34		950	985	1005	1040	1075	1115	1160
			M1	A35		975	1010	1030	1065	1100	1140	1185
			M3	ARMLESS		900	935	955	990	1025	1065	1110
			M3	A34		975	1010	1030	1065	1100	1140	1185
			M3	A35		1000	1035	1055	1090	1125	1165	1210

MODEL	CONTROL	DESCRIPTION	MESH	ARM	MESH/FABRIC	A/COM	B	C	D	E	F	G
3308	S3	8" TRAVEL LOW STOOL SWIVEL TILT CONTROL Use for work surfaces up to 36 inches high.	M1	ARMLESS		875	910	930	965	1000	1040	1085
			M1	A34		950	985	1005	1040	1075	1115	1160
			M1	A35		975	1010	1030	1065	1100	1140	1185
			M3	ARMLESS		900	935	955	990	1025	1065	1110
			M3	A34		975	1010	1030	1065	1100	1140	1185
			M3	A35		1000	1035	1055	1090	1125	1165	1210

FEATURES

- Pneumatic Seat Height Adjustment
- Tilt Tension Control
- Seat and Back Tilt as a Unit
- Upright Position Tilt Lock
- Knob less Height Adjustable Footring
- Upholstered Pad Sewn to Mesh

DIMENSIONS

WIDTH: 28.0
DEPTH: 27.5
HEIGHT: 43.5-53.5
SEAT WIDTH: 19.0
SEAT DEPTH: 16.0
SEAT HEIGHT: 26.0-36.0
BACK WIDTH: 18.0
BACK HEIGHT: 19.5
COM: 2.0 YDS
COL: 12.0 SQ FT
WEIGHT: 42.0 LB

- Pneumatic Seat Height Adjustment
- Tilt Tension Control
- Seat and Back Tilt as a Unit
- Upright Position Tilt Lock
- Knob less Height Adjustable Footring
- Upholstered Pad Sewn to Mesh

WIDTH: 28.0
DEPTH: 27.5
HEIGHT: 39.5-47.5
SEAT WIDTH: 19.0
SEAT DEPTH: 16.0
SEAT HEIGHT: 22.0-30.0
BACK WIDTH: 18.0
BACK HEIGHT: 19.5
COM: 2.0 YDS
COL: 12.0 SQ FT
WEIGHT: 41.0 LB

ARM OPTIONS



Molded Nylon Fixed Loop Arm

A34
\$75



6-way adjustable T-Arm, with soft touch PU caps

A35
\$100

CASTER OPTIONS

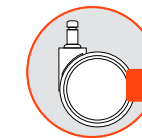

Standard 60mm Hoodless Casters

C6
STD

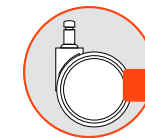

60mm Hoodless Hard Floor Casters

C6S
\$35

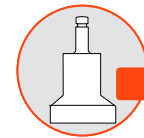

Stationary Base Glides for 5 Star Base

G1
\$30

ADDITIONAL OPTIONS

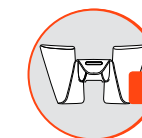

Adjustable Lumbar

LB
\$30



26" High Profile Aluminum Base
 BA10B - Black Powder-Coat
 BA10P - Polished
 BA10S - Silver Powder-Coat

BA10B
BA10P
BA10S
 \$100

ACCENT COLORS

BLACK PBF	GRAY PGF	WHITE PWF	
--------------	-------------	--------------	--

MESH COLORS

	BLACK M11	GRAY M12	SILVER M13	GREEN M14	RED M15	BLUE M16
M1	GRAPHITE M31	SLATE M32	SNOW M33	SAGE M34		
M3	CARDINAL M35	ROYAL M36	TANGERINE M37	PLUM M38		

cydia

organic design meets ergonomic excellence

GSA SIN # 711-18

- Multi-Purpose Guest Seating
- Choice of 3 metal frame colors 3 plastic and 14 mesh colors
- Warranted up to 250 lbs
- CAL TB 133 Fire Code approved



CREATING CYDIA MODEL NUMBER

MODEL NUMBER CONTROL ACCENT COLOR FRAME COLOR UPHOLSTERY MESH COLOR GRADE PACKAGING
3 3 - **P A** - **U P** - **M** - **M**

FRAME COLORS

CODE	DESCRIPTION
BF	BLACK
GF	GRAY
WF	WHITE

PACKAGING NOTES

CODE	DESCRIPTION	LIST UPCHARGE
AB	ASSEMBLED IN BAG FOR WILL CALL	\$0
BAC	BACK ASSEMBLED IN CARTON	\$0

NEW FULLY UPHOLSTERED - GUEST

MODEL	CONTROL	DESCRIPTION	MESH	ARM	MESH/FABRIC						
					A/COM	B	C	D	E	F	G
3300	GT	MID-SIZE GUEST Well suited for guest seating.	M1	SWA	650	685	705	740	775	815	860
			M3	SWA	675	710	730	765	800	840	885
SWA - STANDARD WITH ARMS											

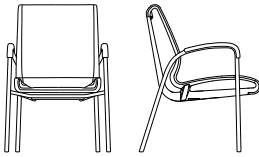

- ### FEATURES
- Non-Marring Floor Glides
 - Wall Saver Back Legs
 - Upholstered Pad Sewn Over Mesh
 - Rated for 250 lbs

- ### DIMENSIONS
- WIDTH:** 23.75
 - DEPTH:** 26.5
 - HEIGHT:** 35.0
 - SEAT WIDTH:** 19.0
 - SEAT DEPTH:** 16.0
 - SEAT HEIGHT:** 18.5
 - BACK WIDTH:** 18.0
 - BACK HEIGHT:** 19.5
 - COM:** 2.0 YDS
 - COL:** 22.0 SQ FT
 - WEIGHT:** 25.0 LB

MODEL	CONTROL	DESCRIPTION	MESH	ARM	MESH/FABRIC						
					A/COM	B	C	D	E	F	G
3310	GT	FULL-SIZE GUEST Well suited for guest seating.	M1	SWA	700	735	755	790	825	865	910
			M3	SWA	735	770	790	825	860	900	945
SWA - STANDARD WITH ARMS											

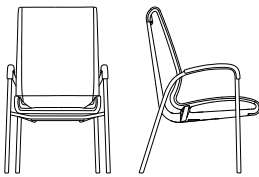

- ### FEATURES
- Non-Marring Floor Glides
 - Wall Saver Back Legs
 - Upholstered Pad Sewn Over Mesh
 - Rated for 250 lbs

- ### DIMENSIONS
- WIDTH:** 23.75
 - DEPTH:** 26.5
 - HEIGHT:** 39.0
 - SEAT WIDTH:** 19.0
 - SEAT DEPTH:** 17.0
 - SEAT HEIGHT:** 18.5
 - BACK WIDTH:** 18.0
 - BACK HEIGHT:** 23.375
 - COM:** 2.0 YDS
 - COL:** 22.0 SQ FT
 - WEIGHT:** 28.0 LB

ADDITIONAL OPTIONS



Adjustable Lumbar

ACCENT COLORS

BLACK PBA	GRAY PGA	WHITE PWA
--------------	-------------	--------------

MESH COLORS

	BLACK M11	GRAY M12	SILVER M13	GREEN M14	RED M15	BLUE M16
M1	GRAPHITE M31	SLATE M32	SNOW M33	SAGE M34		
M3	CARDINAL M35	ROYAL M36	TANGERINE M37	PLUM M38		

diddy

dazzle your conference space

GSA SIN # 711-18 Pending

- Classic styling to impact conference space
- Chrome wraparound arms
- Polished high profile base
- Warranted up to 250 lbs
- CAL TB 133 Fire Code approved



CREATING DITTY MODEL NUMBER

MODEL NUMBER CONTROL ARMS GRADE CASTERS PACKAGING
 2 4 5 0 - S - A - - C - - - -
* FOR ARMLESS CODE USE A00

PACKAGING NOTES

CODE	DESCRIPTION	LIST UPCHARGE
AB	ASSEMBLED IN BAG FOR WILL CALL	\$0
BAC	BACK ASSEMBLED IN CARTON	\$0

NEW MID-BACK

MODEL	CONTROL	DESCRIPTION	ARM	FABRIC	FEATURES	DIMENSIONS																														
<p>NEW MODEL</p> <p>2450</p>	B2	<p>MID-SIZE BASIC CONTROL</p> <p>Use for a variety of general office seating, including private office and conference room seating.</p>	<p>ARMLESS</p> <p>A24</p>	<table border="1"> <thead> <tr> <th>A/COM</th> <th>B</th> <th>C</th> <th>D</th> <th>E</th> <th>F</th> <th>G</th> <th>L3/COL</th> <th>L4</th> <th>L5</th> </tr> </thead> <tbody> <tr> <td>420</td> <td>470</td> <td>500</td> <td>550</td> <td>605</td> <td>665</td> <td>730</td> <td>460</td> <td>560</td> <td>785</td> </tr> <tr> <td>520</td> <td>570</td> <td>600</td> <td>650</td> <td>705</td> <td>765</td> <td>830</td> <td>560</td> <td>660</td> <td>885</td> </tr> </tbody> </table> <p>NOTE: AVAILABLE JUNE 2017</p>	A/COM	B	C	D	E	F	G	L3/COL	L4	L5	420	470	500	550	605	665	730	460	560	785	520	570	600	650	705	765	830	560	660	885	<ul style="list-style-type: none"> • Pneumatic Seat Height Adjustment • 360 Degree Swivel • Rated for 250 lbs 	<p>WIDTH: 21.5</p> <p>DEPTH: 27.5</p> <p>HEIGHT: 32.00-36.50</p> <p>SEAT WIDTH: 19.0</p> <p>SEAT DEPTH: 17.8</p> <p>SEAT HEIGHT: 17-21.5</p> <p>BACK WIDTH: 17.8</p> <p>BACK HEIGHT: 16.5</p> <p>COM: 1.5 YD</p> <p>COL: 19 SQ FT</p> <p>WEIGHT: 32.0 LBS</p>
A/COM	B	C	D	E	F	G	L3/COL	L4	L5																											
420	470	500	550	605	665	730	460	560	785																											
520	570	600	650	705	765	830	560	660	885																											
<p>NEW MODEL</p> <p>2450</p>	S3	<p>MID-SIZE SWIVEL TILT CONTROL</p> <p>Use for a variety of general office seating, including private office and conference room seating.</p>	<p>ARMLESS</p> <p>A24</p>	<table border="1"> <thead> <tr> <th>A/COM</th> <th>B</th> <th>C</th> <th>D</th> <th>E</th> <th>F</th> <th>G</th> <th>L3/COL</th> <th>L4</th> <th>L5</th> </tr> </thead> <tbody> <tr> <td>455</td> <td>505</td> <td>535</td> <td>585</td> <td>640</td> <td>700</td> <td>765</td> <td>495</td> <td>595</td> <td>820</td> </tr> <tr> <td>555</td> <td>605</td> <td>635</td> <td>685</td> <td>740</td> <td>800</td> <td>865</td> <td>595</td> <td>695</td> <td>920</td> </tr> </tbody> </table> <p>NOTE: AVAILABLE JANUARY 2017</p>	A/COM	B	C	D	E	F	G	L3/COL	L4	L5	455	505	535	585	640	700	765	495	595	820	555	605	635	685	740	800	865	595	695	920	<ul style="list-style-type: none"> • Pneumatic Seat Height Adjustment • Adjustable Tilt Tension Control • Rated for 250 lbs 	<p>WIDTH: 21.5</p> <p>DEPTH: 27.5</p> <p>HEIGHT: 32.00-36.50</p> <p>SEAT WIDTH: 19.0</p> <p>SEAT DEPTH: 17.8</p> <p>SEAT HEIGHT: 17-21.5</p> <p>BACK WIDTH: 17.8</p> <p>BACK HEIGHT: 16.5</p> <p>COM: 1.5 YD</p> <p>COL: 19 SQ FT</p> <p>WEIGHT: 32.0 LBS</p>
A/COM	B	C	D	E	F	G	L3/COL	L4	L5																											
455	505	535	585	640	700	765	495	595	820																											
555	605	635	685	740	800	865	595	695	920																											
<p>NEW MODEL</p> <p>2450</p>	GT	<p>MID-SIZE GUEST</p> <p>Diddy guest adds swivel-tilt comfort. Modern design addition to Lobby, Office or group areas.</p>	<p>ARMLESS</p> <p>A24</p>	<table border="1"> <thead> <tr> <th>A/COM</th> <th>B</th> <th>C</th> <th>D</th> <th>E</th> <th>F</th> <th>G</th> <th>L3/COL</th> <th>L4</th> <th>L5</th> </tr> </thead> <tbody> <tr> <td>490</td> <td>540</td> <td>570</td> <td>620</td> <td>675</td> <td>735</td> <td>800</td> <td>530</td> <td>630</td> <td>855</td> </tr> <tr> <td>590</td> <td>640</td> <td>670</td> <td>720</td> <td>775</td> <td>835</td> <td>900</td> <td>630</td> <td>730</td> <td>955</td> </tr> </tbody> </table> <p>NOTE: AVAILABLE JUNE 2017</p>	A/COM	B	C	D	E	F	G	L3/COL	L4	L5	490	540	570	620	675	735	800	530	630	855	590	640	670	720	775	835	900	630	730	955	<ul style="list-style-type: none"> • Fixed Height • Standard with Glides • Adjustable Tilt Tension Control • Rated for 250 lbs 	<p>WIDTH: 21.5</p> <p>DEPTH: 27.5</p> <p>HEIGHT: 33.0</p> <p>SEAT WIDTH: 19.0</p> <p>SEAT DEPTH: 17.8</p> <p>SEAT HEIGHT: 18.0</p> <p>BACK WIDTH: 17.8</p> <p>BACK HEIGHT: 16.5</p> <p>COM: 1.5 YD</p> <p>COL: 19 SQ FT</p> <p>WEIGHT: 32.0 LBS</p>
A/COM	B	C	D	E	F	G	L3/COL	L4	L5																											
490	540	570	620	675	735	800	530	630	855																											
590	640	670	720	775	835	900	630	730	955																											

ARM OPTIONS



CASTER OPTIONS



enduro

designed for 24/7 multi-shift use, enduro holds strong

MID-BACK

GSA SIN # 711-18

- Task, stool, and conference seating
- Warranted up to 350 lbs on M1 and Y2
- 24/7 Multi-shift use
- Cast aluminum base and heavy duty casters standard
- High impact plastic outer back cover standard
- CAL TB 133 Fire Code approved



CREATING ENDURO MODEL NUMBER

MODEL NUMBER CONTROL ARMS GRADE CASTERS PACKAGING OPTIONS

1 9 6 - - - A - - - C - - - - -

* FOR ARMLESS CODE USE A00

PACKAGING NOTES

CODE	DESCRIPTION	LIST UPCHARGE
AB	ASSEMBLED IN BAG FOR WILL CALL	\$0
PAC	PARTIALLY ASSEMBLED IN CARTON	\$0
BAC	BACK ASSEMBLED IN CARTON	\$40

MODEL	CONTROL	DESCRIPTION	ARM	FABRIC	FEATURES	DIMENSIONS	ARM OPTIONS					
1960	Y2	MID-BACK HEAVY DUTY SYNCHRO TILT CONTROL Use for a variety of general office task seating, including private office and conference room seating.	ARMLESS	A/COM	<ul style="list-style-type: none"> • Pneumatic Seat Height Adjustment • Side Tilt Tension Control • Back and Seat Tilt in 2:1 ratio • 4 Locking Positions • Safety Tilt Release • Ratchet Back Height Lumbar Adjustment • Rated for 350 lbs 	WIDTH: 28.0 DEPTH: 25.5 HEIGHT: 36.0-43.5 SEAT WIDTH: 22.0 SEAT DEPTH: 20.0 SEAT HEIGHT: 18.0-22.5 BACK WIDTH: 20.0 BACK HEIGHT: 19.0-22.0 COM: 0.9 YDS WEIGHT: 38.0 LB	A4 \$75 2-way adjustable arm for height A5 \$95 4-way adjustable arm for height and width A16 \$100 Black Soft Touch Cantilever style C-Shaped Arm					
	A4		700	730				750	780	815	855	895
	A5		775	805				825	855	890	930	970
	A6		795	825				845	875	910	950	990
	A7		830	860				880	910	945	985	1025
	A16		850	880				900	930	965	1005	1045
	A90	800	830	850	880	915	955	995				
	A90	900	930	950	980	1015	1055	1095				
1960	M1	MID-BACK MULTI-FUNCTION CONTROL Fully articulating seat and back for the highest level of ergonomic needs. Forward seat pitch adjustment from 0 to 6 degrees.	ARMLESS	A/COM	<ul style="list-style-type: none"> • Pneumatic Seat Height Adjustment • Tilt Tension Control • Seat and Back Tilt as a Unit • Floating Seat Position Tilt Lock • Infinite Back Angle Adj w/ Free Float • Seat Pivots from 0° to 6° Forward • Ratchet Back Height Lumbar Adjustment • Rated for 350 lbs 	WIDTH: 28.0 DEPTH: 25.5 HEIGHT: 36.0-43.5 SEAT WIDTH: 22.0 SEAT DEPTH: 20.0 SEAT HEIGHT: 18.0-22.5 BACK WIDTH: 20.0 BACK HEIGHT: 19.0-22.0 COM: 0.9 YDS WEIGHT: 39.5 LB	A6 \$130 6-way adjustable arm for height, pivots, and with Ura-Soft sliding arm pads A7 \$150 8-way adjustable arm for height, width, pivots, and with Ura-Soft sliding arm pads A90 \$200 2-way height adjustable breakaway arm rotates back to allow easier fit under lower working surfaces					
	A4		740	770				790	820	855	895	935
	A5		815	845				865	895	930	970	1010
	A6		835	865				885	915	950	990	1030
	A7		870	900				920	950	985	1025	1065
	A16		890	920				940	970	1005	1045	1085
	A90	840	870	890	920	955	995	1035				
	A90	940	970	990	1020	1055	1095	1135				
1966	P1	10" STOOL POSTURE BACK CONTROL Use for work surfaces up to 42 inches high.	ARMLESS	A/COM	<ul style="list-style-type: none"> • Pneumatic Seat Height Adjustment • Infinite back angle adjust with free float • Ratchet Back Height Lumbar Adjustment • Height Adjustable Footring • Rated for 250 lbs 	WIDTH: 28.0 DEPTH: 25.5 HEIGHT: 43.0-56.5 SEAT WIDTH: 22.0 SEAT DEPTH: 20.0 SEAT HEIGHT: 25.5-35.5 BACK WIDTH: 20.0 BACK HEIGHT: 19.0-22.0 COM: 0.9 YDS WEIGHT: 37.5 LB	C4 STD Standard 60mm Hoodless Casters C1S \$35 50mm Hooded Hard Floor Casters C2S \$35 50mm Hooded Self-Locking Hard Floor Casters					
	A4		800	830				850	880	915	955	995
	A5		875	905				925	955	990	1030	1070
	A6		895	925				945	975	1010	1050	1090
	A7		930	960				980	1010	1045	1085	1125
	A16		950	980				1000	1030	1065	1105	1145
	A90	900	930	950	980	1015	1055	1095				
	A90	1000	1030	1050	1080	1115	1155	1195				
				SEAT SLIDER (SS) - NOT AVAILABLE								
1968	P1	8" STOOL POSTURE BACK CONTROL Use for work surfaces up to 36 inches high.	ARMLESS	A/COM	<ul style="list-style-type: none"> • Pneumatic Seat Height Adjustment • Infinite back angle adjust with free float • Ratchet Back Height Lumbar Adjustment • Height Adjustable Footring • Rated for 250 lbs 	WIDTH: 28.0 DEPTH: 25.5 HEIGHT: 39.5-50.5 SEAT WIDTH: 22.0 SEAT DEPTH: 20.0 SEAT HEIGHT: 21.5-29.5 BACK WIDTH: 20.0 BACK HEIGHT: 19.0-22.0 COM: 0.9 YDS WEIGHT: 36.5 LB	SS \$60 Seat Slider 2.5" Side Paddle Activated EF1 \$30 1" extra foam on seat MF1 \$50 1" Visco elastic memory foam on seat					
	A4		800	830				850	880	915	955	995
	A5		875	905				925	955	990	1030	1070
	A6		895	925				945	975	1010	1050	1090
	A7		930	960				980	1010	1045	1085	1125
	A16		950	980				1000	1030	1065	1105	1145
	A90	900	930	950	980	1015	1055	1095				
	A90	1000	1030	1050	1080	1115	1155	1195				
				SEAT SLIDER (SS) - NOT AVAILABLE								
1968	P1	8" STOOL POSTURE BACK CONTROL Use for work surfaces up to 36 inches high.	ARMLESS	A/COM	<ul style="list-style-type: none"> • Pneumatic Seat Height Adjustment • Infinite back angle adjust with free float • Ratchet Back Height Lumbar Adjustment • Height Adjustable Footring • Rated for 250 lbs 	WIDTH: 28.0 DEPTH: 25.5 HEIGHT: 39.5-50.5 SEAT WIDTH: 22.0 SEAT DEPTH: 20.0 SEAT HEIGHT: 21.5-29.5 BACK WIDTH: 20.0 BACK HEIGHT: 19.0-22.0 COM: 0.9 YDS WEIGHT: 36.5 LB	UB \$100 Upholstered Outer Back Covered w/ Fabric BNBP1 \$90 Ballistic Nylon Applied Over a Portion of the Lower Backrest Surface BNBP2 \$180 Ballistic Nylon Applied Over a Portion of the Lower Backrest Surface and Full Seat					
	A4		800	830				850	880	915	955	995
	A5		875	905				925	955	990	1030	1070
	A6		895	925				945	975	1010	1050	1090
	A7		930	960				980	1010	1045	1085	1125
	A16		950	980				1000	1030	1065	1105	1145
	A90	900	930	950	980	1015	1055	1095				
	A90	1000	1030	1050	1080	1115	1155	1195				

enduro

designed for 24/7 multi-shift use, enduro holds strong

HIGH-BACK



CREATING ENDURO MODEL NUMBER

MODEL NUMBER CONTROL ARMS GRADE CASTERS PACKAGING OPTIONS

1 9 8 0 - [] [] - A [] [] - [] [] - C 4 [] [] - [] [] [] []

* FOR ARMLESS CODE USE A00

PACKAGING NOTES

CODE	DESCRIPTION	LIST UPCHARGE
AB	ASSEMBLED IN BAG FOR WILL CALL	\$0
PAC	PARTIALLY ASSEMBLED IN CARTON	\$0
BAC	BACK ASSEMBLED IN CARTON	\$40

MODEL	CONTROL	DESCRIPTION	ARM	FABRIC	FEATURES	DIMENSIONS	ARM OPTIONS	CASTER OPTIONS	ADDITIONAL OPTIONS	
1980	Y2	HIGH-BACK HEAVY DUTY SYNCHRO TILT CONTROL Use for a variety of general office task seating, including private office and conference room seating.	ARMLESS A4 A5 A6 A7 A16 A90	A/COM B C D E F G 725 760 780 815 855 895 940 800 835 855 890 930 970 1015 820 855 875 910 950 990 1035 855 890 910 945 985 1025 1070 875 910 930 965 1005 1045 1090 825 860 880 915 955 995 1040 925 960 980 1015 1055 1095 1140	<ul style="list-style-type: none"> Pneumatic Seat Height Adjustment Side Tilt Tension Control Back and Seat Tilt in 2:1 ratio 4 Locking Positions Safety Tilt Release Ratchet Back Height Lumbar Adjustment Rated for 350 lbs 	WIDTH: 28.0 DEPTH: 25.5 HEIGHT: 40.0-47.5 SEAT WIDTH: 22.0 SEAT DEPTH: 20.0 SEAT HEIGHT: 18.0-22.5 BACK WIDTH: 20.0 BACK HEIGHT: 23.0-26.0 COM: 1.0 YDS WEIGHT: 39.0 LB	A4 \$75 A5 \$95 A16 \$100	A6 \$130 A7 \$150 A90 \$200	C4 STD C1S \$35 C2S \$35	SS \$60 EF1 \$30 MF1 \$50 UB \$100 BNBP1 \$90 BNBP2 \$180
1980	M1	HIGH-BACK MULTI-FUNCTION CONTROL Fully articulating seat and back for the highest level of ergonomic needs. Forward seat pitch adjustment from 0 to 6 degrees.	ARMLESS A4 A5 A6 A7 A16 A90	A/COM B C D E F G 765 800 820 855 895 935 980 840 875 895 930 970 1010 1055 860 895 915 950 990 1030 1075 895 930 950 985 1025 1065 1110 915 950 970 1005 1045 1085 1130 865 900 920 955 995 1035 1080 965 1000 1020 1055 1095 1135 1180	<ul style="list-style-type: none"> Pneumatic Seat Height Adjustment Tilt Tension Control Seat and Back Tilt as a Unit Floating Seat Position Tilt Lock Infinite Back Angle Adj w/ Free Float Seat Pivots from 0° to 6° Forward Ratchet Back Height Lumbar Adjustment Rated for 350 lbs 	WIDTH: 28.0 DEPTH: 25.5 HEIGHT: 40.0-47.5 SEAT WIDTH: 22.0 SEAT DEPTH: 20.0 SEAT HEIGHT: 18.0-22.5 BACK WIDTH: 20.0 BACK HEIGHT: 23.0-26.0 COM: 1.0 YDS WEIGHT: 41.0 LB	C4 STD C1S \$35 C2S \$35	SS \$60 EF1 \$30 MF1 \$50 UB \$100 BNBP1 \$90 BNBP2 \$180		

indy

flex back movement yields superior comfort

ALL PLASTIC - AP

GSA SIN # 711-19

- High density, multipurpose stacker
- Seat and back styles include: all plastic, upholstered seat w/ plastic back or fully upholstered seat and back
- Flex back provides 15 degrees of movement
- 11 plastic colors, 2 frame finishes
- Warranted up to 250 lbs



CREATING INDY MODEL NUMBER

MODEL NUMBER	CONTROL	FRAME COLOR	UPHOLSTERY	PLASTIC COLOR	GRADE	PACKAGING	OPTIONS
1	0	0	0	G	T	-	F
				A	P	-	P
				P			

FRAME COLORS

CODE	DESCRIPTION
BF	BLACK
CF	CHROME

PACKAGING NOTES





CODE	DESCRIPTION	LIST UPCHARGE
AB	ASSEMBLED IN BAG FOR WILL CALL	\$0
AC	ASSEMBLED IN CARTON	\$0

INDY CHAIRS SHIP UP TO 5 PER CARTON

MODEL	CONTROL	DESCRIPTION	FRAME COLOR	PLASTIC	FEATURES	DIMENSIONS
1010	GT	GUEST STACKING Armless sled shape frame with plastic back and plastic seat.	BF CF	P 215 225	<ul style="list-style-type: none"> • 15 Degrees of Flex in Back • Non-Marring Floor Glides • Stacks 9 High on Floor • Stacks 33 High on Optional Dolly Maintaining Clearance Under an 80" Doorway • Rated for 250 lbs 	WIDTH: 22.0 DEPTH: 21.5 HEIGHT: 33.0 SEAT WIDTH: 18.0 SEAT DEPTH: 17.5 SEAT HEIGHT: 18.0 BACK WIDTH: 17.0 BACK HEIGHT: 16.0 COM: N/A WEIGHT: 14.0 LB

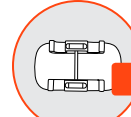
MODEL	CONTROL	DESCRIPTION	FRAME COLOR	PLASTIC	FEATURES	DIMENSIONS
1020	GT	GUEST STACKING Standard with armrests. Sled shape frame with plastic back and plastic seat.	BF CF	P 260 270	<ul style="list-style-type: none"> • 15 Degrees of Flex in Back • Non-Marring Floor Glides • Stacks 9 High on Floor • Stacks 24 High on Optional Dolly Maintaining Clearance Under an 80" Doorway • Plastic Armrests Covers Match Plastic Shell Color • Rated for 250 lbs 	WIDTH: 22.0 DEPTH: 21.5 HEIGHT: 33.0 SEAT WIDTH: 18.0 SEAT DEPTH: 17.5 SEAT HEIGHT: 18.0 BACK WIDTH: 17.0 BACK HEIGHT: 16.0 COM: N/A WEIGHT: 15.0 LB

ACCESSORIES

 <p>DL4 \$250</p> <p>Stacking Dolly Stacks Chairs up to 33 high all plastic armless</p>	 <p>GC5 \$20</p> <p>Ganging Clip - 4 per set Armless-to-Armless or Arm-to-Arm. 2" Between Chairs When Ganged</p>	
 <p>G12 \$15</p> <p>Clear Non-Marring Floor Glides</p>	 <p>G13 \$25</p> <p>Clear Non-Marring Felt Covered Floor Glides</p>	 <p>G15 \$25</p> <p>Plastic Glide with felt base for Sled Base Chair</p>

PLASTIC COLORS

BLACK SWAN P01	CLASSIC BURGUNDY P02	CORAL RED P03	SUNBONNET YELLOW P04
WHITE WHISPER P05	BOULDER GRAY P06	DOVER SKY P07	ESSEX BLUE P08
PALE WATER GREEN P09	CINNABAR ORANGE P10	FEDERAL BLUE P11	

indy

flex back movement yields superior comfort

GSA SIN # 711-19

- High density, multipurpose stacker
- Seat and back styles include: all plastic, upholstered seat w/ plastic back or fully upholstered seat and back
- Flex back provides 15 degrees of movement
- 11 plastic colors, 2 frame finishes
- Warranted up to 250 lbs



UPHOLSTERED SEAT - US

CREATING INDY MODEL NUMBER

MODEL NUMBER CONTROL FRAME COLOR UPHOLSTERY PLASTIC COLOR GRADE PACKAGING OPTIONS

1 0 0 0 - G T - F - U S - P - - - - -

FRAME COLORS

CODE	DESCRIPTION
BF	BLACK
CF	CHROME

PACKAGING NOTES

CODE	DESCRIPTION	LIST UPCHARGE
AB	ASSEMBLED IN BAG FOR WILL CALL	\$0
AC	ASSEMBLED IN CARTON	\$0

INDY CHAIRS SHIP UP TO 4 PER CARTON

NOTE: Due to the nature of vinyl upholstery, stacking may cause impressions on the seat. 9to5 Seating does not warrant the effects of the stacking on vinyl upholstery.

MODEL	CONTROL	DESCRIPTION	FRAME COLOR	FABRIC	A/COM	B	C	D	E	F	G	FEATURES	DIMENSIONS
1010	GT	GUEST STACKING Armless sled shape frame with plastic back and upholstered seat.	BF CF		275 290	300 315	315 330	340 355	365 380	395 410	425 440	<ul style="list-style-type: none"> • 15 Degrees of Flex in Back • Non-Marring Floor Glides • Stacks 7 High on Floor • Stacks 20 High on Optional Dolly Maintaining Clearance Under an 80" Doorway • Rated for 250 lbs 	WIDTH: 22.0 DEPTH: 21.5 HEIGHT: 33.0 SEAT WIDTH: 18.0 SEAT DEPTH: 17.5 SEAT HEIGHT: 18.0 BACK WIDTH: 17.0 BACK HEIGHT: 16.0 COM: 0.7 YDS WEIGHT: 19.0 LB
1020	GT	GUEST STACKING Standard with armrests. Sled shape frame with plastic back and upholstered seat.	BF CF		320 335	345 360	360 375	385 400	410 425	440 455	470 485	<ul style="list-style-type: none"> • 15 Degrees of Flex in Back • Non-Marring Floor Glides • Stacks 7 High on Floor • Stacks 20 High on Optional Dolly Maintaining Clearance Under an 80" Doorway • Plastic Armrests Covers Match Plastic Shell Color • Rated for 250 lbs 	WIDTH: 22.0 DEPTH: 21.5 HEIGHT: 33.0 SEAT WIDTH: 18.0 SEAT DEPTH: 17.5 SEAT HEIGHT: 18.0 BACK WIDTH: 17.0 BACK HEIGHT: 16.0 COM: 0.7 YDS WEIGHT: 20.0 LB

ACCESSORIES



DL4
\$250

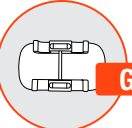

GC5
\$20



G12
\$15



G13
\$25



G15
\$25

PLASTIC COLORS

BLACK SWAN P01	CLASSIC BURGUNDY P02	CORAL RED P03	SUNBONNET YELLOW P04
WHITE WHISPER P05	BOULDER GRAY P06	DOVER SKY P07	ESSEX BLUE P08
PALE WATER GREEN P09	CINNABAR ORANGE P10	FEDERAL BLUE P11	

indy

flex back movement yields superior comfort

FULLY UPHOLSTERED - UP

GSA SIN # 711-19

- High density, multipurpose stacker
- Seat and back styles include: all plastic, upholstered seat w/ plastic back or fully upholstered seat and back
- Flex back provides 15 degrees of movement
- 11 plastic colors, 2 frame finishes
- Warranted up to 250 lbs



CREATING INDY MODEL NUMBER

MODEL NUMBER CONTROL FRAME COLOR UPHOLSTERY PLASTIC COLOR GRADE PACKAGING OPTIONS
1 0 0 0 - G T - F - U P - P - - - - -

FRAME COLORS

CODE	DESCRIPTION
BF	BLACK
CF	CHROME

PACKAGING NOTES

CODE	DESCRIPTION	LIST UPCHARGE
AB	ASSEMBLED IN BAG FOR WILL CALL	\$0
AC	ASSEMBLED IN CARTON	\$0

INDY CHAIRS SHIP UP TO 4 PER CARTON

NOTE: Due to the nature of vinyl upholstery, stacking may cause impressions on the seat. 9to5 Seating does not warrant the effects of the stacking on vinyl upholstery.

MODEL	CONTROL	DESCRIPTION	FRAME COLOR	FABRIC	FEATURES	DIMENSIONS																					
1010	GT	GUEST STACKING Armless sled shape frame with upholstered back and seat.	BF CF	<table border="1"> <thead> <tr> <th>A/COM</th> <th>B</th> <th>C</th> <th>D</th> <th>E</th> <th>F</th> <th>G</th> </tr> </thead> <tbody> <tr> <td>325</td> <td>350</td> <td>370</td> <td>395</td> <td>425</td> <td>460</td> <td>495</td> </tr> <tr> <td>340</td> <td>365</td> <td>385</td> <td>410</td> <td>440</td> <td>475</td> <td>510</td> </tr> </tbody> </table>	A/COM	B	C	D	E	F	G	325	350	370	395	425	460	495	340	365	385	410	440	475	510	<ul style="list-style-type: none"> • 15 Degrees of Flex in Back • Non-Marring Floor Glides • Stacks 7 High on Floor • Stacks 20 High on Optional Dolly Maintaining Clearance Under an 80" Doorway • Rated for 250 lbs 	<p>WIDTH: 22.0 DEPTH: 21.5 HEIGHT: 33.0 SEAT WIDTH: 18.0 SEAT DEPTH: 17.5 SEAT HEIGHT: 18.0 BACK WIDTH: 17.0 BACK HEIGHT: 16.0 COM: 0.8 YDS WEIGHT: 19.0 LB</p>
A/COM	B	C	D	E	F	G																					
325	350	370	395	425	460	495																					
340	365	385	410	440	475	510																					
1020	GT	GUEST STACKING Standard with armrests. Sled shape frame with upholstered back and seat.	BF CF	<table border="1"> <thead> <tr> <th>A/COM</th> <th>B</th> <th>C</th> <th>D</th> <th>E</th> <th>F</th> <th>G</th> </tr> </thead> <tbody> <tr> <td>370</td> <td>395</td> <td>415</td> <td>440</td> <td>470</td> <td>505</td> <td>540</td> </tr> <tr> <td>385</td> <td>410</td> <td>430</td> <td>455</td> <td>485</td> <td>520</td> <td>555</td> </tr> </tbody> </table>	A/COM	B	C	D	E	F	G	370	395	415	440	470	505	540	385	410	430	455	485	520	555	<ul style="list-style-type: none"> • 15 Degrees of Flex in Back • Non-Marring Floor Glides • Stacks 7 High on Floor • Stacks 20 High on Optional Dolly Maintaining Clearance Under an 80" Doorway • Plastic Armrests Covers Match Plastic Shell Color • Rated for 250 lbs 	<p>WIDTH: 22.0 DEPTH: 21.5 HEIGHT: 33.0 SEAT WIDTH: 18.0 SEAT DEPTH: 17.5 SEAT HEIGHT: 18.0 BACK WIDTH: 17.0 BACK HEIGHT: 16.0 COM: 0.8 YDS WEIGHT: 20.0 LB</p>
A/COM	B	C	D	E	F	G																					
370	395	415	440	470	505	540																					
385	410	430	455	485	520	555																					

ACCESSORIES



DL4
\$250

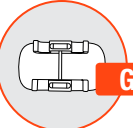

GC5
\$20

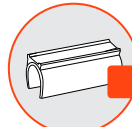

G12
\$15



G13
\$25



G15
\$25

PLASTIC COLORS

BLACK SWAN P01	CLASSIC BURGUNDY P02	CORAL RED P03	SUNBONNET YELLOW P04
WHITE WHISPER P05	BOULDER GRAY P06	DOVER SKY P07	ESSEX BLUE P08
PALE WATER GREEN P09	CINNABAR ORANGE P10	FEDERAL BLUE P11	

kelley

nothing stacks up to kelley

GSA SIN # 711-19

- High density, multipurpose stacker
- 11 plastic colors
- Warranted up to 250 lbs
- Cafe stool Model



ALL PLASTIC - AP

CREATING KELLEY MODEL NUMBER

MODEL NUMBER CONTROL FRAME COLOR UPHOLSTERY PLASTIC COLOR GRADE PACKAGING OPTIONS

1 0 - G T - C F - A P - P - - - - -





FRAME COLOR

CODE	DESCRIPTION
CF	CHROME

PACKAGING NOTES

CODE	DESCRIPTION	LIST UPCHARGE
AB	ASSEMBLED IN BAG FOR WILL CALL	\$0
AC	ASSEMBLED IN CARTON	\$0

KELLEY CHAIRS SHIP UP TO 5 PER CARTON

MODEL	CONTROL	DESCRIPTION	FRAME COLOR	PLASTIC	FEATURES	DIMENSIONS	ADDITIONAL OPTIONS
1060	GT	GUEST STACKING Armless sled shape frame with plastic back and plastic seat.	CF	P 165	<ul style="list-style-type: none"> • Stacks 9 High on Floor • Stacks 33 High on Optional Dolly Maintaining Clearance Under an 80" Doorway • Molded-in Handle • Rated for 250 lbs 	WIDTH: 23.0 DEPTH: 21.0 HEIGHT: 31.0 SEAT WIDTH: 18.0 SEAT DEPTH: 16.5 SEAT HEIGHT: 18.0 BACK WIDTH: 18.0 BACK HEIGHT: 14.5 COM: N/A WEIGHT: 15.0 LB	  
1070	GT	GUEST STACKING Standard with armrests. Sled shape frame with plastic back and plastic seat.	CF	P 210	<ul style="list-style-type: none"> • Stacks 9 High on Floor • Stacks 33 High on Optional Dolly Maintaining Clearance Under an 80" Doorway • Plastic Armrests Covers Match Plastic Shell Color • Molded-in Handle • Rated for 250 lbs 	WIDTH: 24.0 DEPTH: 21.0 HEIGHT: 31.0 SEAT WIDTH: 18.0 SEAT DEPTH: 16.5 SEAT HEIGHT: 18.0 BACK WIDTH: 18.0 BACK HEIGHT: 14.5 COM: N/A WEIGHT: 17.0 LB	
1066	GT	STOOL Armless sled shape frame with plastic back and plastic seat.	CF	P 315	<ul style="list-style-type: none"> • Molded-in Handle • Rated for 250 lbs 	WIDTH: 23.0 DEPTH: 21.0 HEIGHT: 42.5 SEAT WIDTH: 18.0 SEAT DEPTH: 16.5 SEAT HEIGHT: 29.0 BACK WIDTH: 18.0 BACK HEIGHT: 14.5 COM: N/A WEIGHT: 17.0 LB	
1076	GT	STOOL WITH ARMS Standard with armrests. Sled shape frame with plastic back and plastic seat.	CF	P 360	<ul style="list-style-type: none"> • Plastic Armrests Covers Match Plastic Shell Color • Molded-in Handle • Rated for 250 lbs 	WIDTH: 24.0 DEPTH: 21.0 HEIGHT: 42.5 SEAT WIDTH: 18.0 SEAT DEPTH: 16.5 SEAT HEIGHT: 29.0 BACK WIDTH: 18.0 BACK HEIGHT: 14.5 COM: N/A WEIGHT: 18.0 LB	

BLACK SWAN P01	CLASSIC BURGUNDY P02	CORAL RED P03	SUNBRONNET YELLOW P04
WHITE WHISPER P05	BOULDER GRAY P06	DOVER SKY P07	ESSEX BLUE P08
PALE WATER GREEN P09	CINNABAR ORANGE P10	FEDERAL BLUE P11	

kelley

nothing stacks up to kelley

GSA SIN # 711-19

- High density, multipurpose stacker
- 11 plastic colors
- Warranted up to 250 lbs



CREATING KELLEY MODEL NUMBER

MODEL NUMBER CONTROL FRAME COLOR UPHOLSTERY PLASTIC COLOR GRADE PACKAGING OPTIONS
1 0 - **GT** - **CF** - **US** - **P** - **P** - - - -

FRAME COLORS

CODE	DESCRIPTION
CF	CHROME

PACKAGING NOTES

CODE	DESCRIPTION	LIST UPCHARGE
AB	ASSEMBLED IN BAG FOR WILL CALL	\$0
AC	ASSEMBLED IN CARTON	\$0

KELLEY CHAIRS SHIP UP TO 5 PER CARTON

NEW UPHOLSTERED SEAT - US

MODEL	CONTROL	DESCRIPTION	FRAME COLOR	FABRIC	A/COM	B	C	D	E	F	G	FEATURES	DIMENSIONS
1060	GT	GUEST STACKING Armless sled shape frame with plastic back and upholstered seat.	CF		225	255	275	305	340	375	415	<ul style="list-style-type: none"> • Stacks 7 High on Floor • Stacks 20 High on Optional Dolly Maintaining Clearance Under an 80" Doorway • Molded-in Handle • Rated for 250 lbs 	WIDTH: 23.0 DEPTH: 21.0 HEIGHT: 31.0 SEAT WIDTH: 18.0 SEAT DEPTH: 16.5 SEAT HEIGHT: 18.0 BACK WIDTH: 18.0 BACK HEIGHT: 14.5 COM: 0.9 YD WEIGHT: 15.0 LB
1070	GT	GUEST STACKING Standard with armrests. Sled shape frame with plastic back and upholstered seat.	CF		270	300	320	350	385	420	460	<ul style="list-style-type: none"> • Stacks 7 High on Floor • Stacks 20 High on Optional Dolly Maintaining Clearance Under an 80" Doorway • Plastic Armrests Covers Match Plastic Shell Color • Molded-in Handle • Rated for 250 lbs 	WIDTH: 24.0 DEPTH: 21.0 HEIGHT: 31.0 SEAT WIDTH: 18.0 SEAT DEPTH: 16.5 SEAT HEIGHT: 18.0 BACK WIDTH: 18.0 BACK HEIGHT: 14.5 COM: 0.9 YD WEIGHT: 17.0 LB
1066	GT	STOOL Armless sled shape frame with plastic back and upholstered seat.	CF		375	405	425	455	490	525	565	<ul style="list-style-type: none"> • Popular Cafe Height • Molded-in Handle • Rated for 250 lbs 	WIDTH: 23.0 DEPTH: 21.0 HEIGHT: 42.5 SEAT WIDTH: 18.0 SEAT DEPTH: 16.5 SEAT HEIGHT: 29.0 BACK WIDTH: 18.0 BACK HEIGHT: 14.5 COM: 0.9 YD WEIGHT: 17.0 LB
1076	GT	STOOL WITH ARMS Standard with armrests. Sled shape frame with plastic back and upholstered seat.	CF		420	450	470	500	535	570	610	<ul style="list-style-type: none"> • Plastic Armrests Covers Match Plastic Shell Color • Popular Cafe Height • Molded-in Handle • Rated for 250 lbs 	WIDTH: 24.0 DEPTH: 21.0 HEIGHT: 42.5 SEAT WIDTH: 18.0 SEAT DEPTH: 16.5 SEAT HEIGHT: 29.0 BACK WIDTH: 18.0 BACK HEIGHT: 14.5 COM: 0.9 YD WEIGHT: 18.0 LB

ADDITIONAL OPTIONS



G12
\$15

Clear Non-Marring Floor Glides



G13
\$25

Clear Non-Marring Felt Covered Floor Glides



DL4
\$250

Stacking Dolly
Stacks Chairs 20 up to high upholstered



GC5
\$20

Ganging Clip - 4 per set
Armless only. 2" Between Chairs When Ganged

BLACK SWAN P01	CLASSIC BURGUNDY P02	CORAL RED P03	SUNBRONNET YELLOW P04
WHITE WHISPER P05	BOULDER GRAY P06	DOVER SKY P07	ESSEX BLUE P08
PALE WATER GREEN P09	CINNABAR ORANGE P10	FEDERAL BLUE P11	

link

transitional style with limitless possibilities

MESH BACK - MB

GSA SIN # 711-19

- Back styles include: all plastic, upholstered, or mesh back
- 3" Molded foam seat
- 6 powder coated frame finishes
- Wall Saver Legs on Model 1410
- Warranted up to 300 lbs
- CAL TB 133 Fire Code approved



CREATING LINK MODEL NUMBER

MODEL NUMBER CONTROL ARMS FRAME COLOR UPHOLSTERY MESH COLOR GRADE CASTERS PACKAGING OPTIONS

1 4 1 - G T - A - - - - M B - M - - - - C 1 2 - - - -

* FOR ARMLESS CODE USE A00 * ONLY SELECT FOR MODELS 1360/1365 * ONLY SELECT CASTER CODE FOR MODELS 1315/1365

FRAME COLORS

BLACK BF	SILVER SF	METALLIC BROWN* MBF
GUNMETAL* GMF	DOVER GRAY* DGF	WHITE* WF

PACKAGING NOTES

CODE	DESCRIPTION	LIST UPCHARGE
AB	ASSEMBLED IN BAG FOR WILL CALL	\$0
AC	ASSEMBLED IN CARTON	\$0

LINK MESH BACK SIDE CHAIRS SHIP UP TO 3 PER CARTON

NOTE: Due to the nature of vinyl upholstery, stacking may cause impressions on the seat. 9to5 Seating does not warrant the effects of the stacking on vinyl upholstery.

MODEL	CONTROL	DESCRIPTION	ARM	FABRIC/LEATHER	FEATURES	DIMENSIONS	ARM OPTIONS	CASTER OPTIONS																																							
1410	GT	GUEST SIDE CHAIR Mesh back with upholstered seat.	ARMLESS A15B A15G	<table border="1"> <thead> <tr> <th>A/COM</th> <th>B</th> <th>C</th> <th>D</th> <th>E</th> <th>F</th> <th>G</th> <th>L3/COL</th> <th>L4</th> <th>L5</th> </tr> </thead> <tbody> <tr> <td>385</td> <td>420</td> <td>445</td> <td>480</td> <td>520</td> <td>565</td> <td>615</td> <td>475</td> <td>505</td> <td>595</td> </tr> <tr> <td>440</td> <td>475</td> <td>500</td> <td>535</td> <td>575</td> <td>620</td> <td>670</td> <td>530</td> <td>560</td> <td>650</td> </tr> <tr> <td>440</td> <td>475</td> <td>500</td> <td>535</td> <td>575</td> <td>620</td> <td>670</td> <td>530</td> <td>560</td> <td>650</td> </tr> </tbody> </table>	A/COM	B	C	D	E	F	G	L3/COL	L4	L5	385	420	445	480	520	565	615	475	505	595	440	475	500	535	575	620	670	530	560	650	440	475	500	535	575	620	670	530	560	650	<ul style="list-style-type: none"> • Non-Marring Floor Glides • 3" Molded Foam Seat • Stack 4 High on Floor • Stacks 4 High on Optional Dolly • Wall Saver Back Legs Model 1410 • Rated for 300 lbs 	WIDTH: 25.5 DEPTH: 24.0 HEIGHT: 32.0 SEAT WIDTH: 20.0 SEAT DEPTH: 18.0 SEAT HEIGHT: 17.5 BACK WIDTH: 18.0 BACK HEIGHT: 16.0 COM: 1.1 YDS COL: 11.0 SQ FT WEIGHT: 21.0 LB	A15B \$55 Soft Touch Polyurethane Arms - Black Color A15G \$55 Soft Touch Polyurethane Arms - Gray Color C12 STD Standard 50mm Hoodless Casters
A/COM	B	C	D	E	F	G	L3/COL	L4	L5																																						
385	420	445	480	520	565	615	475	505	595																																						
440	475	500	535	575	620	670	530	560	650																																						
440	475	500	535	575	620	670	530	560	650																																						
1415	GT	GUEST SIDE CHAIR WITH CASTERS Mesh back with upholstered seat.	ARMLESS A15B A15G	<table border="1"> <thead> <tr> <th>A/COM</th> <th>B</th> <th>C</th> <th>D</th> <th>E</th> <th>F</th> <th>G</th> <th>L3/COL</th> <th>L4</th> <th>L5</th> </tr> </thead> <tbody> <tr> <td>430</td> <td>465</td> <td>490</td> <td>525</td> <td>565</td> <td>610</td> <td>660</td> <td>520</td> <td>550</td> <td>640</td> </tr> <tr> <td>485</td> <td>520</td> <td>545</td> <td>580</td> <td>620</td> <td>665</td> <td>715</td> <td>575</td> <td>605</td> <td>695</td> </tr> <tr> <td>485</td> <td>520</td> <td>545</td> <td>580</td> <td>620</td> <td>665</td> <td>715</td> <td>575</td> <td>605</td> <td>695</td> </tr> </tbody> </table>	A/COM	B	C	D	E	F	G	L3/COL	L4	L5	430	465	490	525	565	610	660	520	550	640	485	520	545	580	620	665	715	575	605	695	485	520	545	580	620	665	715	575	605	695	<ul style="list-style-type: none"> • 50mm Hoodless Casters • 3" Molded Foam Seat • Stack 4 High on Floor • Stacks 4 High on Optional Dolly • Rated for 300 lbs 	WIDTH: 25.5 DEPTH: 24.0 HEIGHT: 32.0 SEAT WIDTH: 20.0 SEAT DEPTH: 18.0 SEAT HEIGHT: 17.5 BACK WIDTH: 18.0 BACK HEIGHT: 16.0 COM: 1.1 YDS COL: 11.0 SQ FT WEIGHT: 21.0 LB	DL1 \$250 Stacking Dolly Stacks Chairs 4 High CAUTION: Careless stacking of chairs may scratch and damage frames. 9to5 Seating does not warrant scratched frames of side chairs.
A/COM	B	C	D	E	F	G	L3/COL	L4	L5																																						
430	465	490	525	565	610	660	520	550	640																																						
485	520	545	580	620	665	715	575	605	695																																						
485	520	545	580	620	665	715	575	605	695																																						

M1 MESH AVAILABLE ONLY

M1 MESH AVAILABLE ONLY

ACCESSORIES



Stacking Dolly
Stacks Chairs 4 High

CAUTION: Careless stacking of chairs may scratch and damage frames. 9to5 Seating does not warrant scratched frames of side chairs.

MESH COLORS

BLACK M11	GRAY M12	SILVER M13	GREEN M14	RED M15	BLUE M16
--------------	-------------	---------------	--------------	------------	-------------

*Standard twenty five (25) business days applies only to Metallic Brown, Gunmetal, Dover Gray and White frame color options.

link

transitional style with limitless possibilities

PLASTIC BACK - PB

GSA SIN # 711-19

- Back styles include: all plastic, upholstered, or mesh back
- 3" Molded foam seat
- 6 powder coated frame finishes
- Wall Saver Legs on Model 1410
- Warranted up to 300 lbs
- CAL TB 133 Fire Code approved



CREATING LINK MODEL NUMBER

MODEL NUMBER CONTROL ARMS FRAME COLOR UPHOLSTERY MESH COLOR GRADE CASTERS PACKAGING OPTIONS

1 4 1 - G T - A - - - - P B - M - - - - C 1 2 - - - -

* FOR ARMLESS CODE USE A00 * ONLY SELECT FOR MODELS 1360/1365 * ONLY SELECT CASTER CODE FOR MODELS 1315/1365

FRAME COLORS

BLACK BF	SILVER SF	METALLIC BROWN* MBF
GUNMETAL* GMF	DOVER GRAY* DGF	WHITE* WF

PACKAGING NOTES

CODE	DESCRIPTION	LIST UPCHARGE
AB	ASSEMBLED IN BAG FOR WILL CALL	\$0
AC	ASSEMBLED IN CARTON	\$0

LINK PLASTIC BACK SIDE CHAIRS SHIP UP TO 3 PER CARTON

NOTE: Due to the nature of vinyl upholstery, stacking may cause impressions on the seat. 9to5 Seating does not warrant the effects of the stacking on vinyl upholstery.

MODEL	CONTROL	DESCRIPTION	ARM	FABRIC/LEATHER	FEATURES	DIMENSIONS																																										
1410	GT	GUEST Plastic back with upholstered seat.	ARMLESS	<table border="1"> <thead> <tr> <th>A/COM</th> <th>B</th> <th>C</th> <th>D</th> <th>E</th> <th>F</th> <th>G</th> <th>L3/COL</th> <th>L4</th> <th>L5</th> </tr> </thead> <tbody> <tr> <td>350</td> <td>385</td> <td>410</td> <td>445</td> <td>485</td> <td>530</td> <td>580</td> <td>440</td> <td>470</td> <td>560</td> </tr> <tr> <td>A15B</td> <td>405</td> <td>440</td> <td>465</td> <td>500</td> <td>540</td> <td>585</td> <td>635</td> <td>495</td> <td>525</td> <td>615</td> </tr> <tr> <td>A15G</td> <td>405</td> <td>440</td> <td>465</td> <td>500</td> <td>540</td> <td>585</td> <td>635</td> <td>495</td> <td>525</td> <td>615</td> </tr> </tbody> </table>	A/COM	B	C	D	E	F	G	L3/COL	L4	L5	350	385	410	445	485	530	580	440	470	560	A15B	405	440	465	500	540	585	635	495	525	615	A15G	405	440	465	500	540	585	635	495	525	615	<ul style="list-style-type: none"> • Non-Marring Floor Glides • 3" Molded Foam Seat • Stack 4 High on Floor • Stacks 4 High on Optional Dolly • Wall Saver Back Legs Model 1410 • Rated for 300 lbs 	WIDTH: 25.5 DEPTH: 24.0 HEIGHT: 32.0 SEAT WIDTH: 20.0 SEAT DEPTH: 18.0 SEAT HEIGHT: 17.5 BACK WIDTH: 18.0 BACK HEIGHT: 16.0 COM: 1.1 YDS COL: 11.0 SQ FT WEIGHT: 21.0 LB
A/COM	B		C	D	E	F	G	L3/COL	L4	L5																																						
350	385		410	445	485	530	580	440	470	560																																						
A15B	405	440	465	500	540	585	635	495	525	615																																						
A15G	405	440	465	500	540	585	635	495	525	615																																						
1415	GT	GUEST WITH CASTERS Plastic back with upholstered seat.	ARMLESS	<table border="1"> <thead> <tr> <th>A/COM</th> <th>B</th> <th>C</th> <th>D</th> <th>E</th> <th>F</th> <th>G</th> <th>L3/COL</th> <th>L4</th> <th>L5</th> </tr> </thead> <tbody> <tr> <td>395</td> <td>430</td> <td>455</td> <td>490</td> <td>530</td> <td>575</td> <td>625</td> <td>485</td> <td>515</td> <td>605</td> </tr> <tr> <td>A15B</td> <td>450</td> <td>485</td> <td>510</td> <td>545</td> <td>585</td> <td>630</td> <td>680</td> <td>570</td> <td>660</td> </tr> <tr> <td>A15G</td> <td>450</td> <td>485</td> <td>510</td> <td>545</td> <td>585</td> <td>630</td> <td>680</td> <td>570</td> <td>660</td> </tr> </tbody> </table>	A/COM	B	C	D	E	F	G	L3/COL	L4	L5	395	430	455	490	530	575	625	485	515	605	A15B	450	485	510	545	585	630	680	570	660	A15G	450	485	510	545	585	630	680	570	660	<ul style="list-style-type: none"> • 50mm Hoodless Casters • 3" Molded Foam Seat • Stack 4 High on Floor • Stacks 4 High on Optional Dolly • Rated for 300 lbs 	WIDTH: 25.5 DEPTH: 24.0 HEIGHT: 32.0 SEAT WIDTH: 20.0 SEAT DEPTH: 18.0 SEAT HEIGHT: 17.5 BACK WIDTH: 18.0 BACK HEIGHT: 16.0 COM: 1.1 YDS COL: 11.0 SQ FT WEIGHT: 21.0 LB		
A/COM	B		C	D	E	F	G	L3/COL	L4	L5																																						
395	430		455	490	530	575	625	485	515	605																																						
A15B	450	485	510	545	585	630	680	570	660																																							
A15G	450	485	510	545	585	630	680	570	660																																							

ARM OPTIONS

 <p>A15B \$55</p>	 <p>A15G \$55</p>	 <p>C12 STD</p>
---	---	---

ACCESSORIES



DL1
\$250

Stacking Dolly
Stacks Chairs 4 High

CAUTION: Careless stacking of chairs may scratch and damage frames. 9to5 Seating does not warrant scratched frames of side chairs.

*Standard twenty five (25) business days applies only to Metallic Brown, Gunmetal, Dover Gray and White frame color options.

link

transitional style with limitless possibilities

UPHOLSTERED BACK - UB

GSA SIN # 711-18

- Back styles include: all plastic, upholstered, or mesh back
- 3" Molded foam seat
- 6 powder coated frame finishes
- Wall Saver Legs on Model 1410
- Warranted up to 300 lbs
- CAL TB 133 Fire Code approved



CREATING LINK MODEL NUMBER

MODEL NUMBER CONTROL ARMS FRAME COLOR UPHOLSTERY MESH COLOR GRADE CASTERS PACKAGING OPTIONS

1 4 1 - G T - A - - - - U B - M - - - - C 1 2 - - - -

* FOR ARMLESS CODE USE A00 * ONLY SELECT FOR MODELS 1360/1365 * ONLY SELECT CASTER CODE FOR MODELS 1315/1365

FRAME COLORS

BLACK BF	SILVER SF	METALLIC BROWN* MBF
GUNMETAL* GMF	DOVER GRAY* DGF	WHITE* WF

PACKAGING NOTES

CODE	DESCRIPTION	LIST UPCHARGE
AB	ASSEMBLED IN BAG FOR WILL CALL	\$0
AC	ASSEMBLED IN CARTON	\$0

LINK UPHOLSTERED BACK SIDE CHAIRS SHIP UP TO 2 PER CARTON

NOTE: Due to the nature of vinyl upholstery, stacking may cause impressions on the seat. 9to5 Seating does not warrant the effects of the stacking on vinyl upholstery.

MODEL	CONTROL	DESCRIPTION	ARM	FABRIC/LEATHER	FEATURES	DIMENSIONS																																										
1410	GT	GUEST Upholstered back with upholstered seat.	ARMLESS	<table border="1"> <thead> <tr> <th>A/COM</th> <th>B</th> <th>C</th> <th>D</th> <th>E</th> <th>F</th> <th>G</th> <th>L3/COL</th> <th>L4</th> <th>L5</th> </tr> </thead> <tbody> <tr> <td>385</td> <td>430</td> <td>460</td> <td>505</td> <td>555</td> <td>615</td> <td>680</td> <td>500</td> <td>585</td> <td>720</td> </tr> <tr> <td>A15B</td> <td>440</td> <td>485</td> <td>515</td> <td>560</td> <td>610</td> <td>670</td> <td>735</td> <td>555</td> <td>640</td> <td>775</td> </tr> <tr> <td>A15G</td> <td>440</td> <td>485</td> <td>515</td> <td>560</td> <td>610</td> <td>670</td> <td>735</td> <td>555</td> <td>640</td> <td>775</td> </tr> </tbody> </table>	A/COM	B	C	D	E	F	G	L3/COL	L4	L5	385	430	460	505	555	615	680	500	585	720	A15B	440	485	515	560	610	670	735	555	640	775	A15G	440	485	515	560	610	670	735	555	640	775	<ul style="list-style-type: none"> • Non-Marring Floor Glides • 3" Molded Foam Seat • Stack 4 High on Floor • Stacks 4 High on Optional Dolly • Wall Saver Back Legs Model 1410 • Rated for 300 lbs 	WIDTH: 25.5 DEPTH: 24.0 HEIGHT: 32.0 SEAT WIDTH: 20.0 SEAT DEPTH: 18.0 SEAT HEIGHT: 17.5 BACK WIDTH: 18.0 BACK HEIGHT: 16.0 COM: 1.4 YDS COL: 17.0 SQ FT WEIGHT: 23.0 LB
A/COM	B		C	D	E	F	G	L3/COL	L4	L5																																						
385	430		460	505	555	615	680	500	585	720																																						
A15B	440	485	515	560	610	670	735	555	640	775																																						
A15G	440	485	515	560	610	670	735	555	640	775																																						
1415	GT	GUEST WITH CASTERS Upholstered back with upholstered seat.	ARMLESS	<table border="1"> <thead> <tr> <th>A/COM</th> <th>B</th> <th>C</th> <th>D</th> <th>E</th> <th>F</th> <th>G</th> <th>L3/COL</th> <th>L4</th> <th>L5</th> </tr> </thead> <tbody> <tr> <td>430</td> <td>475</td> <td>505</td> <td>550</td> <td>600</td> <td>660</td> <td>725</td> <td>545</td> <td>630</td> <td>765</td> </tr> <tr> <td>A15B</td> <td>485</td> <td>530</td> <td>560</td> <td>605</td> <td>655</td> <td>715</td> <td>780</td> <td>600</td> <td>685</td> <td>820</td> </tr> <tr> <td>A15G</td> <td>485</td> <td>530</td> <td>560</td> <td>605</td> <td>655</td> <td>715</td> <td>780</td> <td>600</td> <td>685</td> <td>820</td> </tr> </tbody> </table>	A/COM	B	C	D	E	F	G	L3/COL	L4	L5	430	475	505	550	600	660	725	545	630	765	A15B	485	530	560	605	655	715	780	600	685	820	A15G	485	530	560	605	655	715	780	600	685	820	<ul style="list-style-type: none"> • 50mm Hoodless Casters • 3" Molded Foam Seat • Stack 4 High on Floor • Stacks 4 High on Optional Dolly • Rated for 300 lbs 	WIDTH: 25.5 DEPTH: 24.0 HEIGHT: 32.0 SEAT WIDTH: 20.0 SEAT DEPTH: 18.0 SEAT HEIGHT: 17.5 BACK WIDTH: 18.0 BACK HEIGHT: 16.0 COM: 1.4 YDS COL: 17.0 SQ FT WEIGHT: 23.0 LB
A/COM	B		C	D	E	F	G	L3/COL	L4	L5																																						
430	475		505	550	600	660	725	545	630	765																																						
A15B	485	530	560	605	655	715	780	600	685	820																																						
A15G	485	530	560	605	655	715	780	600	685	820																																						

ARM OPTIONS

<p>A15B \$55</p> <p>Soft Touch Polyurethane Arms - Black Color</p>	<p>A15G \$55</p> <p>Soft Touch Polyurethane Arms - Gray Color</p>	<p>C12 STD</p> <p>Standard 50mm Hoodless Casters</p>
---	--	---

ACCESSORIES

DL1
\$250

Stacking Dolly
Stacks Chairs 4 High

CAUTION: Careless stacking of chairs may scratch and damage frames. 9to5 Seating does not warrant scratched frames of side chairs.

*Standard twenty five (25) business days applies only to Metallic Brown, Gunmetal, Dover Gray and White frame color options.

logic

ergonomics, traditional task styling - an unbeatable value

MID-BACK

GSA SIN # 711-18

- Task, stool, and conference seating
- Ratchet back height adjustment on R1, M1, and Y2 models
- Warranted up to 250 lbs with S2, R1, P1
- Warranted up to 300 lbs with M1, Y2
- CAL TB 133 Fire Code approved



CREATING LOGIC MODEL NUMBER

MODEL NUMBER CONTROL ARMS GRADE CASTERS PACKAGING OPTIONS

1 7 6 0 - [] [] - A [] [] - [] [] - [] [] [] - [] [] []

* FOR ARMLESS CODE USE A00

PACKAGING NOTES

CODE	DESCRIPTION	LIST UPCHARGE
AB	ASSEMBLED IN BAG FOR WILL CALL	\$0
PAC	PARTIALLY ASSEMBLED IN CARTON	\$0
BAC	BACK ASSEMBLED IN CARTON	\$40

MODEL	CONTROL	DESCRIPTION	ARM	FABRIC/LEATHER	FEATURES	DIMENSIONS	ARM OPTIONS																																																								
1760	S2	MID-BACK SWIVEL TILT CONTROL Use for a variety of general office seating, including private office and conference room seating.	ARMLESS A1 A4 A5 A6 A7 A16	<table border="1"> <thead> <tr> <th>A/COM</th> <th>B</th> <th>C</th> <th>D</th> <th>E</th> <th>F</th> <th>G</th> </tr> </thead> <tbody> <tr><td>465</td><td>515</td><td>550</td><td>600</td><td>660</td><td>725</td><td>795</td></tr> <tr><td>535</td><td>585</td><td>620</td><td>670</td><td>730</td><td>795</td><td>865</td></tr> <tr><td>540</td><td>590</td><td>625</td><td>675</td><td>735</td><td>800</td><td>870</td></tr> <tr><td>560</td><td>610</td><td>645</td><td>695</td><td>755</td><td>820</td><td>890</td></tr> <tr><td>595</td><td>645</td><td>680</td><td>730</td><td>790</td><td>855</td><td>925</td></tr> <tr><td>615</td><td>665</td><td>700</td><td>750</td><td>810</td><td>875</td><td>945</td></tr> <tr><td>565</td><td>615</td><td>650</td><td>700</td><td>760</td><td>825</td><td>895</td></tr> </tbody> </table>	A/COM	B	C	D	E	F	G	465	515	550	600	660	725	795	535	585	620	670	730	795	865	540	590	625	675	735	800	870	560	610	645	695	755	820	890	595	645	680	730	790	855	925	615	665	700	750	810	875	945	565	615	650	700	760	825	895	<ul style="list-style-type: none"> • Pneumatic Seat Height Adjustment • Tilt Tension Control • Seat and Back Tilt as a Unit • Upright Position Tilt Lock • Adjustable Back Depth • Rated for 250 lbs 	<p>WIDTH: 26.5 DEPTH: 26.0 HEIGHT: 39.0-43.5 SEAT WIDTH: 22.0 SEAT DEPTH: 18.5 SEAT HEIGHT: 17.0-21.5 BACK WIDTH: 20.0 BACK HEIGHT: 20.5 COM: 1.6 YDS WEIGHT: 28.5 LB</p>	<p>A1 \$70 Black soft touch loop arm</p> <p>A4 \$75 2-way adjustable arm for height</p> <p>A5 \$95 4-way adjustable arm for height and width</p>
A/COM	B	C	D	E	F	G																																																									
465	515	550	600	660	725	795																																																									
535	585	620	670	730	795	865																																																									
540	590	625	675	735	800	870																																																									
560	610	645	695	755	820	890																																																									
595	645	680	730	790	855	925																																																									
615	665	700	750	810	875	945																																																									
565	615	650	700	760	825	895																																																									
1760	R1	MID-BACK ROCKING CONTROL For managerial and task applications. Similar to a swivel tilt control, with the added comfort of infinite back angle and tilt adjustment.	ARMLESS A1 A4 A5 A6 A7 A16	<table border="1"> <thead> <tr> <th>A/COM</th> <th>B</th> <th>C</th> <th>D</th> <th>E</th> <th>F</th> <th>G</th> </tr> </thead> <tbody> <tr><td>515</td><td>565</td><td>600</td><td>650</td><td>710</td><td>775</td><td>845</td></tr> <tr><td>585</td><td>635</td><td>670</td><td>720</td><td>780</td><td>845</td><td>915</td></tr> <tr><td>590</td><td>640</td><td>675</td><td>725</td><td>785</td><td>850</td><td>920</td></tr> <tr><td>610</td><td>660</td><td>695</td><td>745</td><td>805</td><td>870</td><td>940</td></tr> <tr><td>645</td><td>695</td><td>730</td><td>780</td><td>840</td><td>905</td><td>975</td></tr> <tr><td>665</td><td>715</td><td>750</td><td>800</td><td>860</td><td>925</td><td>995</td></tr> <tr><td>615</td><td>665</td><td>700</td><td>750</td><td>810</td><td>875</td><td>945</td></tr> </tbody> </table>	A/COM	B	C	D	E	F	G	515	565	600	650	710	775	845	585	635	670	720	780	845	915	590	640	675	725	785	850	920	610	660	695	745	805	870	940	645	695	730	780	840	905	975	665	715	750	800	860	925	995	615	665	700	750	810	875	945	<ul style="list-style-type: none"> • Pneumatic Seat Height Adjustment • Tilt Tension Control • Seat and Back Tilt as a Unit • Floating Seat Position Tilt Lock • Infinite Back Angle Adj w/ Free Float • Ratchet Back Height Lumbar Adjustment • Rated for 250 lbs 	<p>WIDTH: 26.5 DEPTH: 26.0 HEIGHT: 39.0-46.5 SEAT WIDTH: 22.0 SEAT DEPTH: 18.5 SEAT HEIGHT: 16.5-21.0 BACK WIDTH: 20.0 BACK HEIGHT: 20.5-23.5 COM: 1.6 YDS WEIGHT: 34.0 LB</p>	<p>A6 \$130 6-way adjustable arm for height, pivots, and with <i>Ura-Soft</i> sliding arm pads</p> <p>A7 \$150 8-way adjustable arm for height, width, pivots, and with <i>Ura-Soft</i> sliding arm pads</p> <p>A16 \$100 Black Soft Touch Cantilever style C-Shaped Arm</p>
A/COM	B	C	D	E	F	G																																																									
515	565	600	650	710	775	845																																																									
585	635	670	720	780	845	915																																																									
590	640	675	725	785	850	920																																																									
610	660	695	745	805	870	940																																																									
645	695	730	780	840	905	975																																																									
665	715	750	800	860	925	995																																																									
615	665	700	750	810	875	945																																																									
1760	M1	MID-BACK MULTI-FUNCTION CONTROL Fully articulating seat and back for the highest level of ergonomic needs. Forward seat pitch adjustment from 0 to 6 degrees.	ARMLESS A1 A4 A5 A6 A7 A16	<table border="1"> <thead> <tr> <th>A/COM</th> <th>B</th> <th>C</th> <th>D</th> <th>E</th> <th>F</th> <th>G</th> </tr> </thead> <tbody> <tr><td>565</td><td>615</td><td>650</td><td>700</td><td>760</td><td>825</td><td>895</td></tr> <tr><td>635</td><td>685</td><td>720</td><td>770</td><td>830</td><td>895</td><td>965</td></tr> <tr><td>640</td><td>690</td><td>725</td><td>775</td><td>835</td><td>900</td><td>970</td></tr> <tr><td>660</td><td>710</td><td>745</td><td>795</td><td>855</td><td>920</td><td>990</td></tr> <tr><td>695</td><td>745</td><td>780</td><td>830</td><td>890</td><td>955</td><td>1025</td></tr> <tr><td>715</td><td>765</td><td>800</td><td>850</td><td>910</td><td>975</td><td>1045</td></tr> <tr><td>665</td><td>715</td><td>750</td><td>800</td><td>860</td><td>925</td><td>995</td></tr> </tbody> </table>	A/COM	B	C	D	E	F	G	565	615	650	700	760	825	895	635	685	720	770	830	895	965	640	690	725	775	835	900	970	660	710	745	795	855	920	990	695	745	780	830	890	955	1025	715	765	800	850	910	975	1045	665	715	750	800	860	925	995	<ul style="list-style-type: none"> • Pneumatic Seat Height Adjustment • Tilt Tension Control • Seat and Back Tilt as a Unit • Floating Seat Position Tilt Lock • Infinite Back Angle Adj w/ Free Float • Seat Pivots from 0° to 6° Forward • Ratchet Back Height Lumbar Adjustment • Rated for 250 lbs 	<p>WIDTH: 26.5 DEPTH: 26.0 HEIGHT: 39.0-46.5 SEAT WIDTH: 22.0 SEAT DEPTH: 18.5 SEAT HEIGHT: 17.0-21.5 BACK WIDTH: 20.0 BACK HEIGHT: 20.5-23.5 COM: 1.6 YDS WEIGHT: 37.5 LB</p>	<p>C1 STD 50mm Hooded Casters</p> <p>C1S \$35 50mm Hooded Hard Floor Casters</p> <p>C2S \$35 50mm Hooded Self-Locking Hard Floor Casters</p>
A/COM	B	C	D	E	F	G																																																									
565	615	650	700	760	825	895																																																									
635	685	720	770	830	895	965																																																									
640	690	725	775	835	900	970																																																									
660	710	745	795	855	920	990																																																									
695	745	780	830	890	955	1025																																																									
715	765	800	850	910	975	1045																																																									
665	715	750	800	860	925	995																																																									
1760	Y2	MID-BACK SYNCHRO TILT CONTROL Use for a variety of general office seating, including private office and conference room seating.	ARMLESS A1 A4 A5 A6 A7 A16	<table border="1"> <thead> <tr> <th>A/COM</th> <th>B</th> <th>C</th> <th>D</th> <th>E</th> <th>F</th> <th>G</th> </tr> </thead> <tbody> <tr><td>545</td><td>595</td><td>630</td><td>680</td><td>740</td><td>805</td><td>875</td></tr> <tr><td>615</td><td>665</td><td>700</td><td>750</td><td>810</td><td>875</td><td>945</td></tr> <tr><td>620</td><td>670</td><td>705</td><td>755</td><td>815</td><td>880</td><td>950</td></tr> <tr><td>640</td><td>690</td><td>725</td><td>775</td><td>835</td><td>900</td><td>970</td></tr> <tr><td>675</td><td>725</td><td>760</td><td>810</td><td>870</td><td>935</td><td>1005</td></tr> <tr><td>695</td><td>745</td><td>780</td><td>830</td><td>890</td><td>955</td><td>1025</td></tr> <tr><td>645</td><td>695</td><td>730</td><td>780</td><td>840</td><td>905</td><td>975</td></tr> </tbody> </table>	A/COM	B	C	D	E	F	G	545	595	630	680	740	805	875	615	665	700	750	810	875	945	620	670	705	755	815	880	950	640	690	725	775	835	900	970	675	725	760	810	870	935	1005	695	745	780	830	890	955	1025	645	695	730	780	840	905	975	<ul style="list-style-type: none"> • Pneumatic Seat Height Adjustment • Side Tilt Tension Control • Back and Seat Tilt in 2:1 ratio • 4 Locking Positions • Safety Tilt Release • Ratchet Back Height Lumbar Adjustment • Rated for 300 lbs 	<p>WIDTH: 26.5 DEPTH: 26.0 HEIGHT: 37.5-45.0 SEAT WIDTH: 22.0 SEAT DEPTH: 18.5-21.5 SEAT HEIGHT: 18.5-23.0 BACK WIDTH: 20.0 BACK HEIGHT: 19.0-22.0 COM: 1.6 YDS WEIGHT: 41.0 LB</p>	<p>BT \$15 Replace Knob with Bolt (for S2 Controls ONLY)</p> <p>MF1 \$50 EF1 - 1" extra foam on seat</p> <p>EP \$60 Edge Protector - a clear vinyl tube placed around the edge of the back cushion</p> <p>SS \$60 Seat Slider 2.5" Side Paddle Activated</p> <p>BN1 \$35 BN2 \$N/C Upholstered Outer Back in Black Ballistic Nylon BN1 - with Grade A ONLY BN2 - with Grade B and Up</p> <p>HD \$125 Heavy Duty Multi-Shift Upgrade to 350 lbs includes BA2B aluminum base and C4 60mm casters</p>
A/COM	B	C	D	E	F	G																																																									
545	595	630	680	740	805	875																																																									
615	665	700	750	810	875	945																																																									
620	670	705	755	815	880	950																																																									
640	690	725	775	835	900	970																																																									
675	725	760	810	870	935	1005																																																									
695	745	780	830	890	955	1025																																																									
645	695	730	780	840	905	975																																																									

logic

ergonomics, traditional task styling - an unbeatable value

STOOL

GSA SIN # 711-18

- Task, stool, and conference seating
- Ratchet back height adjustment on P1
- Warranted up to 250 lbs with P1
- CAL TB 133 Fire Code approved



CREATING LOGIC MODEL NUMBER

MODEL NUMBER CONTROL ARMS GRADE CASTERS PACKAGING OPTIONS

1 7 6 - P 1 - A - - - C - - - - -

* FOR ARMLESS CODE USE A00

PACKAGING NOTES

CODE	DESCRIPTION	LIST UPCHARGE
AB	ASSEMBLED IN BAG FOR WILL CALL	\$0
PAC	PARTIALLY ASSEMBLED IN CARTON	\$0
BAC	BACK ASSEMBLED IN CARTON	\$40

MODEL	CONTROL	DESCRIPTION	ARM	FABRIC/LEATHER	FEATURES	DIMENSIONS	ARM OPTIONS																																																																																																																								
1766	P1	10" STOOL POSTURE BACK CONTROL Use for work surfaces up to 42 inches high.	<table border="1"> <thead> <tr> <th>ARMLESS</th> <th>A/COM</th> <th>B</th> <th>C</th> <th>D</th> <th>E</th> <th>F</th> <th>G</th> </tr> </thead> <tbody> <tr> <td>A1</td> <td>630</td> <td>680</td> <td>715</td> <td>765</td> <td>825</td> <td>890</td> <td>960</td> </tr> <tr> <td>A4</td> <td>700</td> <td>750</td> <td>785</td> <td>835</td> <td>895</td> <td>960</td> <td>1030</td> </tr> <tr> <td>A5</td> <td>705</td> <td>755</td> <td>790</td> <td>840</td> <td>900</td> <td>965</td> <td>1035</td> </tr> <tr> <td>A6</td> <td>725</td> <td>775</td> <td>810</td> <td>860</td> <td>920</td> <td>985</td> <td>1055</td> </tr> <tr> <td>A7</td> <td>760</td> <td>810</td> <td>845</td> <td>895</td> <td>955</td> <td>1020</td> <td>1090</td> </tr> <tr> <td>A16</td> <td>780</td> <td>830</td> <td>865</td> <td>915</td> <td>975</td> <td>1040</td> <td>1110</td> </tr> <tr> <td>A16</td> <td>730</td> <td>780</td> <td>815</td> <td>865</td> <td>925</td> <td>990</td> <td>1060</td> </tr> </tbody> </table>	ARMLESS	A/COM	B	C	D	E	F	G	A1	630	680	715	765	825	890	960	A4	700	750	785	835	895	960	1030	A5	705	755	790	840	900	965	1035	A6	725	775	810	860	920	985	1055	A7	760	810	845	895	955	1020	1090	A16	780	830	865	915	975	1040	1110	A16	730	780	815	865	925	990	1060	<table border="1"> <thead> <tr> <th>A/COM</th> <th>B</th> <th>C</th> <th>D</th> <th>E</th> <th>F</th> <th>G</th> </tr> </thead> <tbody> <tr> <td>630</td> <td>680</td> <td>715</td> <td>765</td> <td>825</td> <td>890</td> <td>960</td> </tr> <tr> <td>700</td> <td>750</td> <td>785</td> <td>835</td> <td>895</td> <td>960</td> <td>1030</td> </tr> <tr> <td>705</td> <td>755</td> <td>790</td> <td>840</td> <td>900</td> <td>965</td> <td>1035</td> </tr> <tr> <td>725</td> <td>775</td> <td>810</td> <td>860</td> <td>920</td> <td>985</td> <td>1055</td> </tr> <tr> <td>760</td> <td>810</td> <td>845</td> <td>895</td> <td>955</td> <td>1020</td> <td>1090</td> </tr> <tr> <td>780</td> <td>830</td> <td>865</td> <td>915</td> <td>975</td> <td>1040</td> <td>1110</td> </tr> <tr> <td>730</td> <td>780</td> <td>815</td> <td>865</td> <td>925</td> <td>990</td> <td>1060</td> </tr> </tbody> </table>	A/COM	B	C	D	E	F	G	630	680	715	765	825	890	960	700	750	785	835	895	960	1030	705	755	790	840	900	965	1035	725	775	810	860	920	985	1055	760	810	845	895	955	1020	1090	780	830	865	915	975	1040	1110	730	780	815	865	925	990	1060	<ul style="list-style-type: none"> • Pneumatic Seat Height Adjustment • Infinite back angle adjust with free float • Ratchet Back Height Lumbar Adjustment • Height Adjustable Footring • Rated for 250 lbs 	<p>WIDTH: 26.5</p> <p>DEPTH: 26.0</p> <p>HEIGHT: 46.5-59.5</p> <p>SEAT WIDTH: 22.0</p> <p>SEAT DEPTH: 18.5</p> <p>SEAT HEIGHT: 24.5-34.5</p> <p>BACK WIDTH: 20.0</p> <p>BACK HEIGHT: 20.5-23.5</p> <p>COM: 1.6 YDS</p> <p>WEIGHT: 43.5 LB</p>	<p>A1 \$70</p> <p>Black soft touch loop arm</p> <p>A4 \$75</p> <p>2-way adjustable arm for height</p> <p>A5 \$95</p> <p>4-way adjustable arm for height and width</p>
ARMLESS	A/COM	B	C	D	E	F	G																																																																																																																								
A1	630	680	715	765	825	890	960																																																																																																																								
A4	700	750	785	835	895	960	1030																																																																																																																								
A5	705	755	790	840	900	965	1035																																																																																																																								
A6	725	775	810	860	920	985	1055																																																																																																																								
A7	760	810	845	895	955	1020	1090																																																																																																																								
A16	780	830	865	915	975	1040	1110																																																																																																																								
A16	730	780	815	865	925	990	1060																																																																																																																								
A/COM	B	C	D	E	F	G																																																																																																																									
630	680	715	765	825	890	960																																																																																																																									
700	750	785	835	895	960	1030																																																																																																																									
705	755	790	840	900	965	1035																																																																																																																									
725	775	810	860	920	985	1055																																																																																																																									
760	810	845	895	955	1020	1090																																																																																																																									
780	830	865	915	975	1040	1110																																																																																																																									
730	780	815	865	925	990	1060																																																																																																																									
1768	P1	8" STOOL POSTURE BACK CONTROL Use for work surfaces up to 36 inches high.	<table border="1"> <thead> <tr> <th>ARMLESS</th> <th>A/COM</th> <th>B</th> <th>C</th> <th>D</th> <th>E</th> <th>F</th> <th>G</th> </tr> </thead> <tbody> <tr> <td>A1</td> <td>630</td> <td>680</td> <td>715</td> <td>765</td> <td>825</td> <td>890</td> <td>960</td> </tr> <tr> <td>A4</td> <td>700</td> <td>750</td> <td>785</td> <td>835</td> <td>895</td> <td>960</td> <td>1030</td> </tr> <tr> <td>A5</td> <td>705</td> <td>755</td> <td>790</td> <td>840</td> <td>900</td> <td>965</td> <td>1035</td> </tr> <tr> <td>A6</td> <td>725</td> <td>775</td> <td>810</td> <td>860</td> <td>920</td> <td>985</td> <td>1055</td> </tr> <tr> <td>A7</td> <td>760</td> <td>810</td> <td>845</td> <td>895</td> <td>955</td> <td>1020</td> <td>1090</td> </tr> <tr> <td>A16</td> <td>780</td> <td>830</td> <td>865</td> <td>915</td> <td>975</td> <td>1040</td> <td>1110</td> </tr> <tr> <td>A16</td> <td>730</td> <td>780</td> <td>815</td> <td>865</td> <td>925</td> <td>990</td> <td>1060</td> </tr> </tbody> </table>	ARMLESS	A/COM	B	C	D	E	F	G	A1	630	680	715	765	825	890	960	A4	700	750	785	835	895	960	1030	A5	705	755	790	840	900	965	1035	A6	725	775	810	860	920	985	1055	A7	760	810	845	895	955	1020	1090	A16	780	830	865	915	975	1040	1110	A16	730	780	815	865	925	990	1060	<table border="1"> <thead> <tr> <th>A/COM</th> <th>B</th> <th>C</th> <th>D</th> <th>E</th> <th>F</th> <th>G</th> </tr> </thead> <tbody> <tr> <td>630</td> <td>680</td> <td>715</td> <td>765</td> <td>825</td> <td>890</td> <td>960</td> </tr> <tr> <td>700</td> <td>750</td> <td>785</td> <td>835</td> <td>895</td> <td>960</td> <td>1030</td> </tr> <tr> <td>705</td> <td>755</td> <td>790</td> <td>840</td> <td>900</td> <td>965</td> <td>1035</td> </tr> <tr> <td>725</td> <td>775</td> <td>810</td> <td>860</td> <td>920</td> <td>985</td> <td>1055</td> </tr> <tr> <td>760</td> <td>810</td> <td>845</td> <td>895</td> <td>955</td> <td>1020</td> <td>1090</td> </tr> <tr> <td>780</td> <td>830</td> <td>865</td> <td>915</td> <td>975</td> <td>1040</td> <td>1110</td> </tr> <tr> <td>730</td> <td>780</td> <td>815</td> <td>865</td> <td>925</td> <td>990</td> <td>1060</td> </tr> </tbody> </table>	A/COM	B	C	D	E	F	G	630	680	715	765	825	890	960	700	750	785	835	895	960	1030	705	755	790	840	900	965	1035	725	775	810	860	920	985	1055	760	810	845	895	955	1020	1090	780	830	865	915	975	1040	1110	730	780	815	865	925	990	1060	<ul style="list-style-type: none"> • Pneumatic Seat Height Adjustment • Infinite back angle adjust with free float • Ratchet Back Height Lumbar Adjustment • Height Adjustable Footring • Rated for 250 lbs 	<p>WIDTH: 26.5</p> <p>DEPTH: 26.0</p> <p>HEIGHT: 43.5-54.5</p> <p>SEAT WIDTH: 22.0</p> <p>SEAT DEPTH: 18.5</p> <p>SEAT HEIGHT: 21.5-29.5</p> <p>BACK WIDTH: 20.0</p> <p>BACK HEIGHT: 20.5-23.5</p> <p>COM: 1.6 YDS</p> <p>WEIGHT: 42.5 LB</p>	<p>A6 \$130</p> <p>6-way adjustable arm for height, pivots, and with Ura-Soft sliding arm pads</p> <p>A7 \$150</p> <p>8-way adjustable arm for height, width, pivots, and with Ura-Soft sliding arm pads</p> <p>A16 \$100</p> <p>Black Soft Touch Cantilever style C-Shaped Arm</p>
ARMLESS	A/COM	B	C	D	E	F	G																																																																																																																								
A1	630	680	715	765	825	890	960																																																																																																																								
A4	700	750	785	835	895	960	1030																																																																																																																								
A5	705	755	790	840	900	965	1035																																																																																																																								
A6	725	775	810	860	920	985	1055																																																																																																																								
A7	760	810	845	895	955	1020	1090																																																																																																																								
A16	780	830	865	915	975	1040	1110																																																																																																																								
A16	730	780	815	865	925	990	1060																																																																																																																								
A/COM	B	C	D	E	F	G																																																																																																																									
630	680	715	765	825	890	960																																																																																																																									
700	750	785	835	895	960	1030																																																																																																																									
705	755	790	840	900	965	1035																																																																																																																									
725	775	810	860	920	985	1055																																																																																																																									
760	810	845	895	955	1020	1090																																																																																																																									
780	830	865	915	975	1040	1110																																																																																																																									
730	780	815	865	925	990	1060																																																																																																																									
							<p>C1 \$70</p> <p>50mm Hooded Casters</p> <p>C1S \$35</p> <p>50mm Hooded Hard Floor Casters</p> <p>C2S \$35</p> <p>50mm Hooded Self-Locking Hard Floor Casters</p>																																																																																																																								
							<p>BN1 \$35</p> <p>BN2 \$N/C</p> <p>Upholstered Outer Back in Black Ballistic Nylon BN1 - with Grade A ONLY BN2 - with Grade B and Up</p> <p>BNBP1 \$90</p> <p>Ballistic Nylon Applied Over a Portion of the Lower Backrest Surface</p> <p>BNBP2 \$180</p> <p>Ballistic Nylon Applied Over a Portion of the Lower Backrest Surface and Full Seat</p> <p>EP \$60</p> <p>Edge Protector - a clear vinyl tube placed around the edge of the back cushion</p> <p>MF1 \$50</p> <p>EF1 \$30</p> <p>EF1 - 1" extra foam on seat MF1 - 1" Visco elastic memory foam on seat</p>																																																																																																																								

logic

ergonomics, traditional task styling - an unbeatable value

HIGH-BACK

GSA SIN # 711-18

- Task, stool, and conference seating
- Ratchet back height adjustment on R1, M1, and Y2 models
- Warranted up to 250 lbs with S2, R1, P1
- Warranted up to 300 lbs with M1, Y2
- CAL TB 133 Fire Code approved



CREATING LOGIC MODEL NUMBER

MODEL NUMBER	CONTROL	ARMS	GRADE	CASTERS	PACKAGING	OPTIONS
1780		A		C		

* FOR ARMLESS CODE USE A00

PACKAGING NOTES

CODE	DESCRIPTION	LIST UPCHARGE
AB	ASSEMBLED IN BAG FOR WILL CALL	\$0
PAC	PARTIALLY ASSEMBLED IN CARTON	\$0
BAC	BACK ASSEMBLED IN CARTON	\$40

MODEL CONTROL DESCRIPTION



HIGH-BACK SWIVEL TILT CONTROL

Use for a variety of general office seating, including private office and conference room seating.

ARM FABRIC/LEATHER

ARM	A/COM	B	C	D	E	F	G
ARMLESS	515	575	615	675	745	820	905
A1	585	645	685	745	815	890	975
A4	590	650	690	750	820	895	980
A5	610	670	710	770	840	915	1000
A6	645	705	745	805	875	950	1035
A7	665	725	765	825	895	970	1055
A16	615	675	715	775	845	920	1005

SEAT SLIDER (SS) - ADD \$60

FEATURES

- Pneumatic Seat Height Adjustment
- Tilt Tension Control
- Seat and Back Tilt as a Unit
- Upright Position Tilt Lock
- Adjustable Back Depth
- Rated for 250 lbs

DIMENSIONS

WIDTH: 26.5
 DEPTH: 26.0
 HEIGHT: 42.0
 SEAT WIDTH: 22.0
 SEAT DEPTH: 18.5
 SEAT HEIGHT: 17.0-21.5
 BACK WIDTH: 20.0
 BACK HEIGHT: 24.0
 COM: 1.9 YDS
 WEIGHT: 36.0 LB

ARM OPTIONS

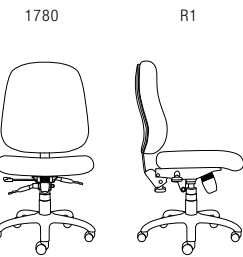
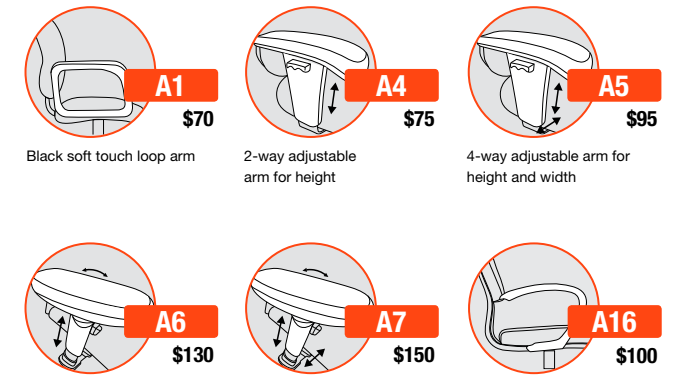

HIGH-BACK ROCKING CONTROL

For managerial and task applications. Similar to a swivel tilt control, with the added comfort of infinite back angle and tilt adjustment.

ARM FABRIC/LEATHER

ARM	A/COM	B	C	D	E	F	G
ARMLESS	565	625	665	725	795	870	955
A1	635	695	735	795	865	940	1025
A4	640	700	740	800	870	945	1030
A5	660	720	760	820	890	965	1050
A6	695	755	795	855	925	1000	1085
A7	715	775	815	875	945	1020	1105
A16	665	725	765	825	895	970	1055

SEAT SLIDER (SS) - ADD \$60

- Pneumatic Seat Height Adjustment
- Tilt Tension Control
- Seat and Back Tilt as a Unit
- Floating Seat Position Tilt Lock
- Infinite Back Angle Adj w/ Free Float
- Ratchet Back Height Lumbar Adjustment
- Rated for 250 lbs

WIDTH: 26.5
 DEPTH: 26.0
 HEIGHT: 42.0-49.5
 SEAT WIDTH: 22.0
 SEAT DEPTH: 18.5
 SEAT HEIGHT: 17.0-21.5
 BACK WIDTH: 20.0
 BACK HEIGHT: 24.0-27.0
 COM: 1.9 YDS
 WEIGHT: 41.0 LB

CASTER OPTIONS

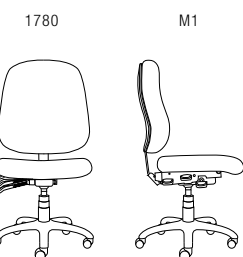

HIGH-BACK MULTI-FUNCTION CONTROL

Fully articulating seat and back for the highest level of ergonomic needs. Forward seat pitch adjustment from 0 to 6 degrees.

ARM FABRIC/LEATHER

ARM	A/COM	B	C	D	E	F	G
ARMLESS	615	675	715	775	845	920	1005
A1	685	745	785	845	915	990	1075
A4	690	750	790	850	920	995	1080
A5	710	770	810	870	940	1015	1100
A6	745	805	845	905	975	1050	1135
A7	765	825	865	925	995	1070	1155
A16	715	775	815	875	945	1020	1105

SEAT SLIDER (SS) - ADD \$60

- Pneumatic Seat Height Adjustment
- Tilt Tension Control
- Seat and Back Tilt as a Unit
- Floating Seat Position Tilt Lock
- Infinite Back Angle Adj w/ Free Float
- Seat Pivots from 0° to 6° Forward
- Ratchet Back Height Lumbar Adjustment
- Rated for 300 lbs

WIDTH: 26.5
 DEPTH: 26.0
 HEIGHT: 42.0-49.5
 SEAT WIDTH: 22.0
 SEAT DEPTH: 18.5
 SEAT HEIGHT: 17.0-21.5
 BACK WIDTH: 20.0
 BACK HEIGHT: 24.0-27.0
 COM: 1.9 YDS
 WEIGHT: 45.0 LB

ADDITIONAL OPTIONS

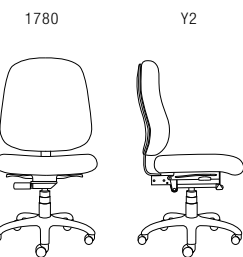
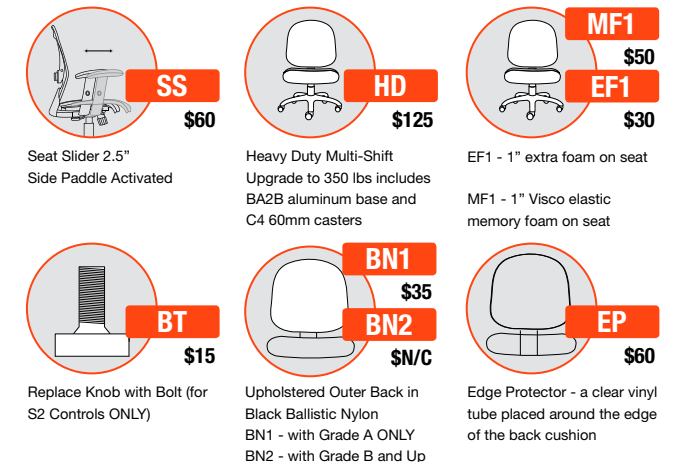

HIGH-BACK SYNCHRO TILT CONTROL

Use for a variety of general office seating, including private office and conference room seating.

ARM FABRIC/LEATHER

ARM	A/COM	B	C	D	E	F	G
ARMLESS	595	655	695	755	825	900	985
A1	665	725	765	825	895	970	1055
A4	670	730	770	830	900	975	1060
A5	690	750	790	850	920	995	1080
A6	725	785	825	885	955	1030	1115
A7	745	805	845	905	975	1050	1135
A16	695	755	795	855	925	1000	1085

SEAT SLIDER (SS) - ADD \$60

- Pneumatic Seat Height Adjustment
- Side Tilt Tension Control
- Back and Seat Tilt in 2:1 ratio
- 4 Locking Positions
- Safety Tilt Release
- Ratchet Back Height Lumbar Adjustment
- Rated for 300 lbs

WIDTH: 26.5
 DEPTH: 26.0
 HEIGHT: 40.5-48.0
 SEAT WIDTH: 22.0
 SEAT DEPTH: 18.5
 SEAT HEIGHT: 17.0-21.5
 BACK WIDTH: 20.0
 BACK HEIGHT: 22.5-25.5
 COM: 1.9 YDS
 WEIGHT: 43.0 LB

logic plus

Plus size ergonomics, traditional task styling - an unbeatable value

HIGH-BACK

GSA SIN # 711-18

- Task seating
- Ratchet back height adjustment
- Warranted up to 500 lbs
- Seat slider standard
- Heavy duty 5 prong base
- Heavy duty gas lift
- Heavy duty M2 control



CREATING LOGIC PLUS MODEL NUMBER

MODEL NUMBER	CONTROL	ARMS	GRADE	CASTERS	PACKAGING	OPTIONS
1790	M2	A		C4		

* FOR ARMLESS CODE USE A00

PACKAGING NOTES

CODE	DESCRIPTION	LIST UPCHARGE
AB	ASSEMBLED IN BAG FOR WILL CALL	\$0
PAC	PARTIALLY ASSEMBLED IN CARTON	\$0

MODEL	CONTROL	DESCRIPTION	ARM	FABRIC/LEATHER	FEATURES	DIMENSIONS																																			
1790	M2	HIGH-BACK HEAVY DUTY MULTI-FUNCTION CONTROL Fully articulating seat and back for the highest level of ergonomic needs. Forward seat pitch adjustment from 0 to 6 degrees.	ARMLESS	<table border="1"> <thead> <tr> <th>A/COM</th> <th>B</th> <th>C</th> <th>D</th> <th>E</th> <th>F</th> <th>G</th> </tr> </thead> <tbody> <tr> <td>790</td> <td>895</td> <td>965</td> <td>1070</td> <td>1190</td> <td>1325</td> <td>1470</td> </tr> <tr> <td>950</td> <td>1055</td> <td>1125</td> <td>1230</td> <td>1350</td> <td>1485</td> <td>1630</td> </tr> <tr> <td>990</td> <td>1095</td> <td>1165</td> <td>1270</td> <td>1390</td> <td>1525</td> <td>1670</td> </tr> <tr> <td>915</td> <td>1020</td> <td>1090</td> <td>1195</td> <td>1315</td> <td>1450</td> <td>1595</td> </tr> </tbody> </table>	A/COM	B	C	D	E	F	G	790	895	965	1070	1190	1325	1470	950	1055	1125	1230	1350	1485	1630	990	1095	1165	1270	1390	1525	1670	915	1020	1090	1195	1315	1450	1595	<ul style="list-style-type: none"> • Heavy Duty Pneumatic Seat Height Adjustment • Tilt Tension Control • Back and Seat Tilt as unit • Floating seat position Tilt Lock • Infinite Back Angle Adj w /Free Float • Seat Pivots up to 6 degrees forward w/ Adjustable Front Tilt Stop • Built-in Seat Slider • Ratchet Back Height Lumbar Adj • 26" Diameter 5 Prong Base • Rated for 500 lbs 	WIDTH: 30.0-33.0 DEPTH: 28.0 HEIGHT: 43.5-52.0 SEAT WIDTH: 25.0 SEAT DEPTH: 17.0-20.0 SEAT HEIGHT: 17.0-22.0 BACK WIDTH: 23.5 BACK HEIGHT: 26.5-30.5 COM: 3.3 YDS WEIGHT: 65.0 LB
A/COM	B		C	D	E	F	G																																		
790	895		965	1070	1190	1325	1470																																		
950	1055		1125	1230	1350	1485	1630																																		
990	1095	1165	1270	1390	1525	1670																																			
915	1020	1090	1195	1315	1450	1595																																			
	A5 HD																																								
	A90																																								
	A37																																								
				SEAT SLIDER (SS) - STANDARD WITH THIS CONFIGURATION																																					



ARM OPTIONS

 <p>A5 HD \$160</p> <p>4-way adjustable arm height and width</p>	 <p>A90 \$200</p> <p>2-way height adjustable breakaway arm rotates back to allow easier fit under lower working surfaces</p>	 <p>A37 \$125</p> <p>10-Way Adjustable Arms soft-touch sliding and pivoting arm pads and 4" arm width knob under seat.</p>
--	--	--

CASTER OPTIONS

 <p>C4 STD</p> <p>Standard 60mm Hoodless Casters</p>	 <p>C1S \$35</p> <p>50mm Hooded Hard Floor Casters</p>	 <p>C2S \$35</p> <p>50mm Hooded Self-Locking Hard Floor Casters</p>
--	--	---

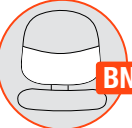
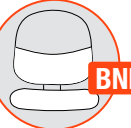
ADDITIONAL OPTIONS

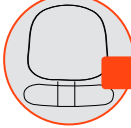
 <p>BN1 \$35</p> <p>Upholstered Outer Back in Black Ballistic Nylon</p>	 <p>BN2 \$N/C</p> <p>BN1 - with Grade A ONLY BN2 - with Grade B and Up</p>	 <p>BNBP1 \$90</p> <p>Ballistic Nylon Applied Over a Portion of the Lower Backrest Surface</p>	 <p>BNBP2 \$180</p> <p>Ballistic Nylon Applied Over a Portion of the Lower Backrest Surface and Full Seat</p>
 <p>EP \$60</p> <p>Edge Protector - a clear vinyl tube placed around the edge of the back cushion</p>			

precept

breadth of configurations with an unparalleled value

LOW-BACK

GSA SIN # 711-18

- Task, stool, and conference seating
- Ratchet back height adjustment on P1, R1, M1, and Y2 models
- Warranted up to 250 lbs with B2, S2, R1, and P1
- Warranted up to 300 lbs with M1 and Y2
- CAL TB 133 Fire Code approved



CREATING PRECEPT MODEL NUMBER

MODEL NUMBER CONTROL ARMS GRADE CASTERS PACKAGING OPTIONS

1 7 2 5 - - A - - - C 1 - - - - -

* FOR ARMLESS CODE USE A00

PACKAGING NOTES

CODE	DESCRIPTION	LIST UPCHARGE
AB	ASSEMBLED IN BAG FOR WILL CALL	\$0
PAC	PARTIALLY ASSEMBLED IN CARTON	\$0
BAC	BACK ASSEMBLED IN CARTON	\$40

MODEL	CONTROL	DESCRIPTION	ARM	FABRIC	FEATURES	DIMENSIONS	ARM OPTIONS
1725	B2	LOW-BACK BASIC CONTROL Our basic control has simple adjustments. Ideal for clerical, casual meetings, and general office use.	ARMLESS A1 A4 A5 A6 A7 A16	A/COM B C D E F G 360 400 425 465 515 570 630 530 570 595 635 685 740 800 435 475 500 540 590 645 705 455 495 520 560 610 665 725 490 530 555 595 645 700 760 510 550 575 615 665 720 780 460 500 525 565 615 670 730	<ul style="list-style-type: none"> • 360 degree swivel • Pneumatic Seat Height Adjustment • Adjustable back depth • Rated for 250 lbs 	WIDTH: 26.5 DEPTH: 26.5 HEIGHT: 35.0-39.5 SEAT WIDTH: 22.0 SEAT DEPTH: 17.0 SEAT HEIGHT: 17.5-22.0 BACK WIDTH: 19.5 BACK HEIGHT: 18.5 COM: 1.4 YDS WEIGHT: 28.0 LB	
1725	S2	LOW-BACK SWIVEL TILT CONTROL Use for a variety of general office seating, including private office and conference room seating.	ARMLESS A1 A4 A5 A6 A7 A16	A/COM B C D E F G 405 445 470 510 560 615 675 575 615 640 680 730 785 845 480 520 545 585 635 690 750 500 540 565 605 655 710 770 535 575 600 640 690 745 805 555 595 620 660 710 765 825 505 545 570 610 660 715 775	<ul style="list-style-type: none"> • Pneumatic Seat Height Adjustment • Tilt Tension Control • Seat and Back Tilt as a Unit • Upright Position Tilt Lock • Adjustable back depth • Rated for 250 lbs 	WIDTH: 26.5 DEPTH: 26.5 HEIGHT: 35.0-39.5 SEAT WIDTH: 22.0 SEAT DEPTH: 17.0 SEAT HEIGHT: 17.5-22.0 BACK WIDTH: 19.5 BACK HEIGHT: 18.5 COM: 1.4 YDS WEIGHT: 31.0 LB	
1725	P1	LOW-BACK POSTURE BACK CONTROL The articulating back provides proper support for moderate tasking applications.	ARMLESS A1 A4 A5 A6 A7 A16	A/COM B C D E F G 445 485 510 550 600 655 715 615 655 680 720 770 825 885 520 560 585 625 675 730 790 540 580 605 645 695 750 810 575 615 640 680 730 785 845 595 635 660 700 750 805 865 545 585 610 650 700 755 815	<ul style="list-style-type: none"> • Pneumatic Seat Height Adjustment • Infinite back angle adjust with free float • Ratchet Back Height Lumbar Adjustment • Rated for 250 lbs 	WIDTH: 26.5 DEPTH: 26.5 HEIGHT: 35.0-42.5 SEAT WIDTH: 22.0 SEAT DEPTH: 17.0 SEAT HEIGHT: 17.5-22.0 BACK WIDTH: 19.5 BACK HEIGHT: 18.5-21.5 COM: 1.4 YDS WEIGHT: 33.0 LB	
1725	R1	LOW-BACK ROCKING CONTROL For managerial and task applications. Similar to a swivel tilt control, with the added comfort of infinite back angle and tilt adjustment.	ARMLESS A1 A4 A5 A6 A7 A16	A/COM B C D E F G 455 495 520 560 610 665 725 625 665 690 730 780 835 895 530 570 595 635 685 740 800 550 590 615 655 705 760 820 585 625 650 690 740 795 855 605 645 670 710 760 815 875 555 595 620 660 710 765 825	<ul style="list-style-type: none"> • Pneumatic Seat Height Adjustment • Tilt Tension Control • Seat and Back Tilt as a Unit • Floating Seat Position Tilt Lock • Infinite Back Angle Adj w/ Free Float • Ratchet Back Height Lumbar Adjustment • Rated for 250 lbs 	WIDTH: 26.5 DEPTH: 26.5 HEIGHT: 35.0-42.5 SEAT WIDTH: 22.0 SEAT DEPTH: 17.0 SEAT HEIGHT: 17.5-22.0 BACK WIDTH: 19.5 BACK HEIGHT: 18.5-21.5 COM: 1.4 YDS WEIGHT: 35.0 LB	

precept

breadth of configurations with an unparalleled value

LOW-BACK

GSA SIN # 711-18

- Task, stool, and conference seating
- Ratchet back height adjustment on P1, R1, M1, and Y2 models
- Warranted up to 250 lbs with B2, S2, R1, and P1
- Warranted up to 300 lbs with M1 and Y2
- CAL TB 133 Fire Code approved



CREATING PRECEPT MODEL NUMBER

MODEL NUMBER CONTROL ARMS GRADE CASTERS PACKAGING OPTIONS

1 7 2 5 - [] [] - A [] [] - [] [] [] - [] [] [] - [] [] []

* FOR ARMLESS CODE USE A00 * GT MODELS DO NOT HAVE A CASTER CODE

PACKAGING NOTES

CODE	DESCRIPTION	LIST UPCHARGE
AB	ASSEMBLED IN BAG FOR WILL CALL	\$0
PAC	PARTIALLY ASSEMBLED IN CARTON	\$0
BAC	BACK ASSEMBLED IN CARTON	\$40

MODEL	CONTROL	DESCRIPTION	ARM	FABRIC	FEATURES	DIMENSIONS	ARM OPTIONS																																																																																																																
1725	M1	LOW-BACK MULTI-FUNCTION CONTROL Fully articulating seat and back for the highest level of ergonomic needs. Forward seat pitch adjustment from 0 to 6 degrees.	<table border="1"> <tr><td>ARMLESS</td><td>505</td><td>545</td><td>570</td><td>610</td><td>660</td><td>715</td><td>775</td></tr> <tr><td>A1</td><td>675</td><td>715</td><td>740</td><td>780</td><td>830</td><td>885</td><td>945</td></tr> <tr><td>A4</td><td>580</td><td>620</td><td>645</td><td>685</td><td>735</td><td>790</td><td>850</td></tr> <tr><td>A5</td><td>600</td><td>640</td><td>665</td><td>705</td><td>755</td><td>810</td><td>870</td></tr> <tr><td>A6</td><td>635</td><td>675</td><td>700</td><td>740</td><td>790</td><td>845</td><td>905</td></tr> <tr><td>A7</td><td>655</td><td>695</td><td>720</td><td>760</td><td>810</td><td>865</td><td>925</td></tr> <tr><td>A16</td><td>605</td><td>645</td><td>670</td><td>710</td><td>760</td><td>815</td><td>875</td></tr> </table>	ARMLESS	505	545	570	610	660	715	775	A1	675	715	740	780	830	885	945	A4	580	620	645	685	735	790	850	A5	600	640	665	705	755	810	870	A6	635	675	700	740	790	845	905	A7	655	695	720	760	810	865	925	A16	605	645	670	710	760	815	875	<table border="1"> <tr><td>A/COM</td><td>B</td><td>C</td><td>D</td><td>E</td><td>F</td><td>G</td></tr> <tr><td>505</td><td>545</td><td>570</td><td>610</td><td>660</td><td>715</td><td>775</td></tr> <tr><td>675</td><td>715</td><td>740</td><td>780</td><td>830</td><td>885</td><td>945</td></tr> <tr><td>580</td><td>620</td><td>645</td><td>685</td><td>735</td><td>790</td><td>850</td></tr> <tr><td>600</td><td>640</td><td>665</td><td>705</td><td>755</td><td>810</td><td>870</td></tr> <tr><td>635</td><td>675</td><td>700</td><td>740</td><td>790</td><td>845</td><td>905</td></tr> <tr><td>655</td><td>695</td><td>720</td><td>760</td><td>810</td><td>865</td><td>925</td></tr> <tr><td>605</td><td>645</td><td>670</td><td>710</td><td>760</td><td>815</td><td>875</td></tr> </table>	A/COM	B	C	D	E	F	G	505	545	570	610	660	715	775	675	715	740	780	830	885	945	580	620	645	685	735	790	850	600	640	665	705	755	810	870	635	675	700	740	790	845	905	655	695	720	760	810	865	925	605	645	670	710	760	815	875	<ul style="list-style-type: none"> • Pneumatic Seat Height Adjustment • Tilt Tension Control • Seat and Back Tilt as a Unit • Floating Seat Position Tilt Lock • Infinite Back Angle Adj w/ Free Float • Seat Pivots from 0° to 6° Forward • Ratchet Back Height Lumbar Adjustment • Rated for 300 lbs 	<p>WIDTH: 26.5 DEPTH: 26.5 HEIGHT: 35.0-42.5 SEAT WIDTH: 22.0 SEAT DEPTH: 17.0 SEAT HEIGHT: 17.5-22.0 BACK WIDTH: 19.5 BACK HEIGHT: 18.5-21.5 COM: 1.4 YDS WEIGHT: 39.0 LB</p>	<p>A1 \$70 Black soft touch loop arm</p> <p>A4 \$75 2-way adjustable arm for height</p> <p>A5 \$95 4-way adjustable arm for height and width</p>
ARMLESS	505	545	570	610	660	715	775																																																																																																																
A1	675	715	740	780	830	885	945																																																																																																																
A4	580	620	645	685	735	790	850																																																																																																																
A5	600	640	665	705	755	810	870																																																																																																																
A6	635	675	700	740	790	845	905																																																																																																																
A7	655	695	720	760	810	865	925																																																																																																																
A16	605	645	670	710	760	815	875																																																																																																																
A/COM	B	C	D	E	F	G																																																																																																																	
505	545	570	610	660	715	775																																																																																																																	
675	715	740	780	830	885	945																																																																																																																	
580	620	645	685	735	790	850																																																																																																																	
600	640	665	705	755	810	870																																																																																																																	
635	675	700	740	790	845	905																																																																																																																	
655	695	720	760	810	865	925																																																																																																																	
605	645	670	710	760	815	875																																																																																																																	
1725	Y2-SS	LOW-BACK SYNCHRO TILT CONTROL Use for a variety of general office seating, including private office and conference room seating.	<table border="1"> <tr><td>ARMLESS</td><td>545</td><td>585</td><td>610</td><td>650</td><td>700</td><td>755</td><td>815</td></tr> <tr><td>A1</td><td>715</td><td>755</td><td>780</td><td>820</td><td>870</td><td>925</td><td>985</td></tr> <tr><td>A4</td><td>620</td><td>660</td><td>685</td><td>725</td><td>775</td><td>830</td><td>890</td></tr> <tr><td>A5</td><td>640</td><td>680</td><td>705</td><td>745</td><td>795</td><td>850</td><td>910</td></tr> <tr><td>A6</td><td>675</td><td>715</td><td>740</td><td>780</td><td>830</td><td>885</td><td>945</td></tr> <tr><td>A7</td><td>695</td><td>735</td><td>760</td><td>800</td><td>850</td><td>905</td><td>965</td></tr> <tr><td>A16</td><td>645</td><td>685</td><td>710</td><td>750</td><td>800</td><td>855</td><td>915</td></tr> </table>	ARMLESS	545	585	610	650	700	755	815	A1	715	755	780	820	870	925	985	A4	620	660	685	725	775	830	890	A5	640	680	705	745	795	850	910	A6	675	715	740	780	830	885	945	A7	695	735	760	800	850	905	965	A16	645	685	710	750	800	855	915	<table border="1"> <tr><td>A/COM</td><td>B</td><td>C</td><td>D</td><td>E</td><td>F</td><td>G</td></tr> <tr><td>545</td><td>585</td><td>610</td><td>650</td><td>700</td><td>755</td><td>815</td></tr> <tr><td>715</td><td>755</td><td>780</td><td>820</td><td>870</td><td>925</td><td>985</td></tr> <tr><td>620</td><td>660</td><td>685</td><td>725</td><td>775</td><td>830</td><td>890</td></tr> <tr><td>640</td><td>680</td><td>705</td><td>745</td><td>795</td><td>850</td><td>910</td></tr> <tr><td>675</td><td>715</td><td>740</td><td>780</td><td>830</td><td>885</td><td>945</td></tr> <tr><td>695</td><td>735</td><td>760</td><td>800</td><td>850</td><td>905</td><td>965</td></tr> <tr><td>645</td><td>685</td><td>710</td><td>750</td><td>800</td><td>855</td><td>915</td></tr> </table>	A/COM	B	C	D	E	F	G	545	585	610	650	700	755	815	715	755	780	820	870	925	985	620	660	685	725	775	830	890	640	680	705	745	795	850	910	675	715	740	780	830	885	945	695	735	760	800	850	905	965	645	685	710	750	800	855	915	<ul style="list-style-type: none"> • Pneumatic Seat Height Adjustment • Side Tilt Tension Control • Back and Seat Tilt in 2:1 ratio • 4 Locking Positions • Safety Tilt Release • Ratchet Back Height Lumbar Adjustment • SS Seat Slider standard • Rated for 300 lbs 	<p>WIDTH: 26.5 DEPTH: 26.5 HEIGHT: 33.5-41.0 SEAT WIDTH: 22.0 SEAT DEPTH: 17.0-19.5 SEAT HEIGHT: 19.0-23.5 BACK WIDTH: 19.5 BACK HEIGHT: 18.5-21.5 COM: 1.4 YDS WEIGHT: 41.0 LB</p>	<p>A6 \$130 6-way adjustable arm for height, pivots, and with <i>Ura-Soft</i> sliding arm pads</p> <p>A7 \$150 8-way adjustable arm for height, width, pivots, and with <i>Ura-Soft</i> sliding arm pads</p> <p>A16 \$100 Black Soft Touch Cantilever style C-Shaped Arm</p>
ARMLESS	545	585	610	650	700	755	815																																																																																																																
A1	715	755	780	820	870	925	985																																																																																																																
A4	620	660	685	725	775	830	890																																																																																																																
A5	640	680	705	745	795	850	910																																																																																																																
A6	675	715	740	780	830	885	945																																																																																																																
A7	695	735	760	800	850	905	965																																																																																																																
A16	645	685	710	750	800	855	915																																																																																																																
A/COM	B	C	D	E	F	G																																																																																																																	
545	585	610	650	700	755	815																																																																																																																	
715	755	780	820	870	925	985																																																																																																																	
620	660	685	725	775	830	890																																																																																																																	
640	680	705	745	795	850	910																																																																																																																	
675	715	740	780	830	885	945																																																																																																																	
695	735	760	800	850	905	965																																																																																																																	
645	685	710	750	800	855	915																																																																																																																	
				SEAT SLIDER (SS) - STANDARD WITH THIS CONFIGURATION																																																																																																																			
1725	GT	GUEST Well suited for guest seating.	<table border="1"> <tr><td>ARMLESS</td><td>340</td><td>380</td><td>405</td><td>445</td><td>495</td><td>550</td><td>610</td></tr> <tr><td>A1</td><td>410</td><td>550</td><td>575</td><td>615</td><td>665</td><td>720</td><td>780</td></tr> </table>	ARMLESS	340	380	405	445	495	550	610	A1	410	550	575	615	665	720	780	<table border="1"> <tr><td>A/COM</td><td>B</td><td>C</td><td>D</td><td>E</td><td>F</td><td>G</td></tr> <tr><td>340</td><td>380</td><td>405</td><td>445</td><td>495</td><td>550</td><td>610</td></tr> <tr><td>410</td><td>550</td><td>575</td><td>615</td><td>665</td><td>720</td><td>780</td></tr> </table>	A/COM	B	C	D	E	F	G	340	380	405	445	495	550	610	410	550	575	615	665	720	780	<ul style="list-style-type: none"> • Cantilever base design • Rated for 250 lbs • Black Powder-Coated Frame 	<p>WIDTH: 26.5 DEPTH: 26.5 HEIGHT: 35.5 SEAT WIDTH: 22.0 SEAT DEPTH: 17.0 SEAT HEIGHT: 17.0 BACK WIDTH: 19.5 BACK HEIGHT: 18.5 COM: 1.4 YDS WEIGHT: 38.0 LB</p>	<p>BT \$15 Replace Knob with Bolt (for S2 Controls ONLY)</p> <p>EF1 \$30 1" extra foam on seat</p> <p>MF1 \$50 1" Visco elastic memory foam on seat</p>																																																																											
ARMLESS	340	380	405	445	495	550	610																																																																																																																
A1	410	550	575	615	665	720	780																																																																																																																
A/COM	B	C	D	E	F	G																																																																																																																	
340	380	405	445	495	550	610																																																																																																																	
410	550	575	615	665	720	780																																																																																																																	
				SHIPS PARTIALLY ASSEMBLED PAC OR AB																																																																																																																			
								ADDITIONAL OPTIONS																																																																																																															
								<p>SS \$60 Seat Slider 2.5" Side Paddle Activated</p> <p>BN1 \$35 BN2 \$N/C Upholstered Outer Back in Black Ballistic Nylon BN1 - with Grade A ONLY BN2 - with Grade B and Up</p> <p>EP \$60 Edge Protector - a clear vinyl tube placed around the edge of the back cushion</p>																																																																																																															

precept

breadth of configurations with an unparalleled value

STOOL

GSA SIN # 711-18

- Task, stool, and conference seating
- Ratchet back height adjustment on P1,
- Warranted up to 250 lbs with B2, and P1
- CAL TB 133 Fire Code approved



CREATING PRECEPT MODEL NUMBER

MODEL NUMBER CONTROL ARMS GRADE CASTERS PACKAGING OPTIONS
1 7 2 - - - **A** - - - **C 1** - - - - -

* FOR ARMLESS CODE USE A00

PACKAGING NOTES

CODE	DESCRIPTION	LIST UPCHARGE
AB	ASSEMBLED IN BAG FOR WILL CALL	\$0
PAC	PARTIALLY ASSEMBLED IN CARTON	\$0
BAC	BACK ASSEMBLED IN CARTON	\$40

MODEL	CONTROL	DESCRIPTION	ARM	FABRIC	FEATURES	DIMENSIONS	ARM OPTIONS																																																								
1726	B2	10" STOOL BASIC CONTROL Use for work surfaces up to 42 inches high.	ARMLESS A1 A4 A5 A6 A7 A16	<table border="1"> <thead> <tr> <th>A/COM</th> <th>B</th> <th>C</th> <th>D</th> <th>E</th> <th>F</th> <th>G</th> </tr> </thead> <tbody> <tr><td>485</td><td>525</td><td>550</td><td>590</td><td>640</td><td>695</td><td>755</td></tr> <tr><td>655</td><td>695</td><td>720</td><td>760</td><td>810</td><td>865</td><td>925</td></tr> <tr><td>560</td><td>600</td><td>625</td><td>665</td><td>715</td><td>770</td><td>830</td></tr> <tr><td>580</td><td>620</td><td>645</td><td>685</td><td>735</td><td>790</td><td>850</td></tr> <tr><td>615</td><td>655</td><td>680</td><td>720</td><td>770</td><td>825</td><td>885</td></tr> <tr><td>635</td><td>675</td><td>700</td><td>740</td><td>790</td><td>845</td><td>905</td></tr> <tr><td>585</td><td>625</td><td>650</td><td>690</td><td>740</td><td>795</td><td>855</td></tr> </tbody> </table>	A/COM	B	C	D	E	F	G	485	525	550	590	640	695	755	655	695	720	760	810	865	925	560	600	625	665	715	770	830	580	620	645	685	735	790	850	615	655	680	720	770	825	885	635	675	700	740	790	845	905	585	625	650	690	740	795	855	<ul style="list-style-type: none"> • 360 degree swivel • Pneumatic Seat Height Adjustment • Adjustable back depth • Height Adjustable Footring • Rated for 250 lbs 	<p>WIDTH: 26.5 DEPTH: 26.5 HEIGHT: 42.5-52.5 SEAT WIDTH: 22.0 SEAT DEPTH: 17.0 SEAT HEIGHT: 25.0-35.0 BACK WIDTH: 19.5 BACK HEIGHT: 18.5 COM: 1.4 YDS WEIGHT: 32.0 LB</p>	<p>A1 \$70 Black soft touch loop arm</p> <p>A4 \$75 2-way adjustable arm for height</p> <p>A5 \$95 4-way adjustable arm for height and width</p>
A/COM	B	C	D	E	F	G																																																									
485	525	550	590	640	695	755																																																									
655	695	720	760	810	865	925																																																									
560	600	625	665	715	770	830																																																									
580	620	645	685	735	790	850																																																									
615	655	680	720	770	825	885																																																									
635	675	700	740	790	845	905																																																									
585	625	650	690	740	795	855																																																									
1726	P1	10" STOOL POSTURE BACK CONTROL Use for work surfaces up to 42 inches high.	ARMLESS A1 A4 A5 A6 A7 A16	<table border="1"> <thead> <tr> <th>A/COM</th> <th>B</th> <th>C</th> <th>D</th> <th>E</th> <th>F</th> <th>G</th> </tr> </thead> <tbody> <tr><td>570</td><td>610</td><td>635</td><td>675</td><td>725</td><td>780</td><td>840</td></tr> <tr><td>740</td><td>780</td><td>805</td><td>845</td><td>895</td><td>950</td><td>1010</td></tr> <tr><td>645</td><td>685</td><td>710</td><td>750</td><td>800</td><td>855</td><td>915</td></tr> <tr><td>665</td><td>705</td><td>730</td><td>770</td><td>820</td><td>875</td><td>935</td></tr> <tr><td>700</td><td>740</td><td>765</td><td>805</td><td>855</td><td>910</td><td>970</td></tr> <tr><td>720</td><td>760</td><td>785</td><td>825</td><td>875</td><td>930</td><td>990</td></tr> <tr><td>670</td><td>710</td><td>735</td><td>775</td><td>825</td><td>880</td><td>940</td></tr> </tbody> </table>	A/COM	B	C	D	E	F	G	570	610	635	675	725	780	840	740	780	805	845	895	950	1010	645	685	710	750	800	855	915	665	705	730	770	820	875	935	700	740	765	805	855	910	970	720	760	785	825	875	930	990	670	710	735	775	825	880	940	<ul style="list-style-type: none"> • Pneumatic Seat Height Adjustment • Infinite back angle adjust with free float • Ratchet Back Height Lumbar Adjustment • Height Adjustable Footring • Rated for 250 lbs 	<p>WIDTH: 26.5 DEPTH: 26.5 HEIGHT: 42.5-55.5 SEAT WIDTH: 22.0 SEAT DEPTH: 17.0 SEAT HEIGHT: 25.0-35.0 BACK WIDTH: 19.5 BACK HEIGHT: 18.5-21.5 COM: 1.4 YDS WEIGHT: 36.0 LB</p>	<p>A6 \$130 6-way adjustable arm for height, pivots, and with <i>Ura-Soft</i> sliding arm pads</p> <p>A7 \$150 8-way adjustable arm for height, width, pivots, and with <i>Ura-Soft</i> sliding arm pads</p> <p>A16 \$100 Black Soft Touch Cantilever style C-Shaped Arm</p>
A/COM	B	C	D	E	F	G																																																									
570	610	635	675	725	780	840																																																									
740	780	805	845	895	950	1010																																																									
645	685	710	750	800	855	915																																																									
665	705	730	770	820	875	935																																																									
700	740	765	805	855	910	970																																																									
720	760	785	825	875	930	990																																																									
670	710	735	775	825	880	940																																																									
1728	B2	8" STOOL BASIC CONTROL Use for work surfaces up to 36 inches high.	ARMLESS A1 A4 A5 A6 A7 A16	<table border="1"> <thead> <tr> <th>A/COM</th> <th>B</th> <th>C</th> <th>D</th> <th>E</th> <th>F</th> <th>G</th> </tr> </thead> <tbody> <tr><td>485</td><td>525</td><td>550</td><td>590</td><td>640</td><td>695</td><td>755</td></tr> <tr><td>655</td><td>695</td><td>720</td><td>760</td><td>810</td><td>865</td><td>925</td></tr> <tr><td>560</td><td>600</td><td>625</td><td>665</td><td>715</td><td>770</td><td>830</td></tr> <tr><td>580</td><td>620</td><td>645</td><td>685</td><td>735</td><td>790</td><td>850</td></tr> <tr><td>615</td><td>655</td><td>680</td><td>720</td><td>770</td><td>825</td><td>885</td></tr> <tr><td>635</td><td>675</td><td>700</td><td>740</td><td>790</td><td>845</td><td>905</td></tr> <tr><td>585</td><td>625</td><td>650</td><td>690</td><td>740</td><td>795</td><td>855</td></tr> </tbody> </table>	A/COM	B	C	D	E	F	G	485	525	550	590	640	695	755	655	695	720	760	810	865	925	560	600	625	665	715	770	830	580	620	645	685	735	790	850	615	655	680	720	770	825	885	635	675	700	740	790	845	905	585	625	650	690	740	795	855	<ul style="list-style-type: none"> • 360 degree swivel • Pneumatic Seat Height Adjustment • Adjustable back depth • Height Adjustable Footring • Rated for 250 lbs 	<p>WIDTH: 26.5 DEPTH: 26.5 HEIGHT: 38.5-46.5 SEAT WIDTH: 22.0 SEAT DEPTH: 17.0 SEAT HEIGHT: 21.0-29.0 BACK WIDTH: 19.5 BACK HEIGHT: 18.5 COM: 1.4 YDS WEIGHT: 31.0 LB</p>	<p>C1 STD 50mm Hooded Casters</p> <p>C1S \$35 50mm Hooded Hard Floor Casters</p> <p>C2S \$35 50mm Hooded Self-Locking Hard Floor Casters</p>
A/COM	B	C	D	E	F	G																																																									
485	525	550	590	640	695	755																																																									
655	695	720	760	810	865	925																																																									
560	600	625	665	715	770	830																																																									
580	620	645	685	735	790	850																																																									
615	655	680	720	770	825	885																																																									
635	675	700	740	790	845	905																																																									
585	625	650	690	740	795	855																																																									
1728	P1	8" STOOL POSTURE BACK CONTROL Use for work surfaces up to 36 inches high.	ARMLESS A1 A4 A5 A6 A7 A16	<table border="1"> <thead> <tr> <th>A/COM</th> <th>B</th> <th>C</th> <th>D</th> <th>E</th> <th>F</th> <th>G</th> </tr> </thead> <tbody> <tr><td>570</td><td>610</td><td>635</td><td>675</td><td>725</td><td>780</td><td>840</td></tr> <tr><td>740</td><td>780</td><td>805</td><td>845</td><td>895</td><td>950</td><td>1010</td></tr> <tr><td>645</td><td>685</td><td>710</td><td>750</td><td>800</td><td>855</td><td>915</td></tr> <tr><td>665</td><td>705</td><td>730</td><td>770</td><td>820</td><td>875</td><td>935</td></tr> <tr><td>700</td><td>740</td><td>765</td><td>805</td><td>855</td><td>910</td><td>970</td></tr> <tr><td>720</td><td>760</td><td>785</td><td>825</td><td>875</td><td>930</td><td>990</td></tr> <tr><td>670</td><td>710</td><td>735</td><td>775</td><td>825</td><td>880</td><td>940</td></tr> </tbody> </table>	A/COM	B	C	D	E	F	G	570	610	635	675	725	780	840	740	780	805	845	895	950	1010	645	685	710	750	800	855	915	665	705	730	770	820	875	935	700	740	765	805	855	910	970	720	760	785	825	875	930	990	670	710	735	775	825	880	940	<ul style="list-style-type: none"> • Pneumatic Seat Height Adjustment • Infinite back angle adjust with free float • Ratchet Back Height Lumbar Adjustment • Height Adjustable Footring • Rated for 250 lbs 	<p>WIDTH: 26.5 DEPTH: 26.5 HEIGHT: 38.5-49.5 SEAT WIDTH: 22.0 SEAT DEPTH: 17.0 SEAT HEIGHT: 21.0-29.0 BACK WIDTH: 19.5 BACK HEIGHT: 18.5-21.5 COM: 1.4 YDS WEIGHT: 35.0 LB</p>	<p>BT \$15 Replace Knob with Bolt (for S2 Controls ONLY)</p> <p>EF1 \$30 1" extra foam on seat</p> <p>MF1 \$50 1" Visco elastic memory foam on seat</p> <p>BN1 \$35 BN2 \$N/C Upholstered Outer Back in Black Ballistic Nylon BN1 - with Grade A ONLY BN2 - with Grade B and Up</p> <p>EP \$60 Edge Protector - a clear vinyl tube placed around the edge of the back cushion</p>
A/COM	B	C	D	E	F	G																																																									
570	610	635	675	725	780	840																																																									
740	780	805	845	895	950	1010																																																									
645	685	710	750	800	855	915																																																									
665	705	730	770	820	875	935																																																									
700	740	765	805	855	910	970																																																									
720	760	785	825	875	930	990																																																									
670	710	735	775	825	880	940																																																									

shuttle

the ultimate utility chair

ALL PLASTIC - AP

GSA SIN # 711-19

- Seat and back styles include: all plastic, upholstered seat w/ plastic back or fully upholstered seat and back
- Bariatric, stools and tablet models available
- 11 plastic colors, 6 frame finishes
- Wall saver design on model 1210 and 1260
- Warranted up to 300 lbs
- CAL TB 133 Fire Code approved



CREATING SHUTTLE MODEL NUMBER

MODEL NUMBER CONTROL ARMS FRAME COLOR UPHOLSTERY MESH COLOR PLASTIC COLOR GRADE CASTERS PACKAGING

1 2 - G T - A - P - M - P - P - P - P - P - P

* FOR ARMLESS CODE USE A00 * ONLY SELECT CASTER CODE FOR MODEL 1215, 1265

FRAME COLORS

BLACK BF	SILVER SF	METALLIC BROWN* MBF
GUNMETAL* GMF	DOVER GRAY* DGF	WHITE* WF

PACKAGING NOTES

CODE	DESCRIPTION	LIST UPCHARGE
AB	ASSEMBLED IN BAG FOR WILL CALL	\$0
AC	ASSEMBLED IN CARTON	\$0

SHUTTLE SIDE CHAIRS SHIP UP TO 3 PER CARTON

MODEL	CONTROL	DESCRIPTION	MESH	ARM	PLASTIC	FEATURES	DIMENSIONS	ARM OPTIONS	CASTER OPTIONS																					
1210	GT	GUEST STACKING Plastic back with plastic seat.		ARMLESS A18B A18G TLF/TRF OS	P 245 290 290 395 395	<ul style="list-style-type: none"> • Non-Marring Floor Glides • Stack 4 High on Floor • Stacks 10 High on Optional Dolly • Wall Saver Back Legs • Rated for 300 lbs 	<table border="1"> <tr> <th>ARMLESS</th> <th>W/ ARMS</th> </tr> <tr> <td>WIDTH: 21.5</td> <td>25.5</td> </tr> <tr> <td>DEPTH: 25.0</td> <td>25.0</td> </tr> <tr> <td>HEIGHT: 33.0</td> <td>33.0</td> </tr> <tr> <td>SEAT WIDTH: 19.5</td> <td>19.5</td> </tr> <tr> <td>SEAT DEPTH: 17.0</td> <td>17.0</td> </tr> <tr> <td>SEAT HEIGHT: 17.0</td> <td>17.0</td> </tr> <tr> <td>BACK WIDTH: 20.0</td> <td>20.0</td> </tr> <tr> <td>BACK HEIGHT: 16.0</td> <td>16.0</td> </tr> <tr> <td>COM: N/A</td> <td>N/A</td> </tr> <tr> <td>WEIGHT: 17.0 LB</td> <td>20.0 LB</td> </tr> </table>	ARMLESS	W/ ARMS	WIDTH: 21.5	25.5	DEPTH: 25.0	25.0	HEIGHT: 33.0	33.0	SEAT WIDTH: 19.5	19.5	SEAT DEPTH: 17.0	17.0	SEAT HEIGHT: 17.0	17.0	BACK WIDTH: 20.0	20.0	BACK HEIGHT: 16.0	16.0	COM: N/A	N/A	WEIGHT: 17.0 LB	20.0 LB	<p>A18B A18G \$45</p> <p>Soft Touch Polyurethane Arms - Black or Gray Color</p> <p>OS \$190</p> <p>Left or Right OverSize Tablet *Not Stackable with Tablet</p> <p>C5 STD</p> <p>Standard 50mm Hooded Casters</p>
ARMLESS	W/ ARMS																													
WIDTH: 21.5	25.5																													
DEPTH: 25.0	25.0																													
HEIGHT: 33.0	33.0																													
SEAT WIDTH: 19.5	19.5																													
SEAT DEPTH: 17.0	17.0																													
SEAT HEIGHT: 17.0	17.0																													
BACK WIDTH: 20.0	20.0																													
BACK HEIGHT: 16.0	16.0																													
COM: N/A	N/A																													
WEIGHT: 17.0 LB	20.0 LB																													
1215	GT	GUEST STACKING WITH CASTERS Plastic back with plastic seat.		ARMLESS A18B A18G	P 290 335 335	<ul style="list-style-type: none"> • 50mm Hooded Casters • Stack 4 High on Floor • Stacks 10 High on Optional Dolly • Wall Saver Back Legs • Rated for 300 lbs 	<table border="1"> <tr> <th>ARMLESS</th> <th>W/ ARMS</th> </tr> <tr> <td>WIDTH: 21.5</td> <td>25.5</td> </tr> <tr> <td>DEPTH: 25.0</td> <td>25.0</td> </tr> <tr> <td>HEIGHT: 33.0</td> <td>33.0</td> </tr> <tr> <td>SEAT WIDTH: 19.5</td> <td>19.5</td> </tr> <tr> <td>SEAT DEPTH: 17.0</td> <td>17.0</td> </tr> <tr> <td>SEAT HEIGHT: 17.0</td> <td>17.0</td> </tr> <tr> <td>BACK WIDTH: 20.0</td> <td>20.0</td> </tr> <tr> <td>BACK HEIGHT: 16.0</td> <td>16.0</td> </tr> <tr> <td>COM: N/A</td> <td>N/A</td> </tr> <tr> <td>WEIGHT: 17.0 LB</td> <td>20.0 LB</td> </tr> </table>	ARMLESS	W/ ARMS	WIDTH: 21.5	25.5	DEPTH: 25.0	25.0	HEIGHT: 33.0	33.0	SEAT WIDTH: 19.5	19.5	SEAT DEPTH: 17.0	17.0	SEAT HEIGHT: 17.0	17.0	BACK WIDTH: 20.0	20.0	BACK HEIGHT: 16.0	16.0	COM: N/A	N/A	WEIGHT: 17.0 LB	20.0 LB	<p>TLF \$150</p> <p>Left Folding Tablet Arm in Black Laminate. Available with Black Frame only *Not Stackable with Tablet</p> <p>TRF \$150</p> <p>Right Folding Tablet Arm in Black Laminate. Available with Black Frame only *Not Stackable with Tablet</p> <p>C5S \$30</p> <p>50mm Hooded Hard Floor Casters</p>
ARMLESS	W/ ARMS																													
WIDTH: 21.5	25.5																													
DEPTH: 25.0	25.0																													
HEIGHT: 33.0	33.0																													
SEAT WIDTH: 19.5	19.5																													
SEAT DEPTH: 17.0	17.0																													
SEAT HEIGHT: 17.0	17.0																													
BACK WIDTH: 20.0	20.0																													
BACK HEIGHT: 16.0	16.0																													
COM: N/A	N/A																													
WEIGHT: 17.0 LB	20.0 LB																													
1260	GT	GUEST STACKING Mesh back with plastic seat.	M1 M1 M1 M2/M3 M2/M3 M2/M3	ARMLESS A18B A18G ARMLESS A18B A18G	P 310 355 355 340 385 385	<ul style="list-style-type: none"> • Non-Marring Floor Glides • Stack 4 High on Floor • Stacks 10 High on Optional Dolly • Wall Saver Back Legs • Rated for 300 lbs 	<table border="1"> <tr> <th>ARMLESS</th> <th>W/ ARMS</th> </tr> <tr> <td>WIDTH: 21.5</td> <td>25.5</td> </tr> <tr> <td>DEPTH: 25.0</td> <td>25.0</td> </tr> <tr> <td>HEIGHT: 42.0</td> <td>42.0</td> </tr> <tr> <td>SEAT WIDTH: 19.5</td> <td>19.5</td> </tr> <tr> <td>SEAT DEPTH: 17.0</td> <td>17.0</td> </tr> <tr> <td>SEAT HEIGHT: 27.0</td> <td>27.0</td> </tr> <tr> <td>BACK WIDTH: 20.0</td> <td>20.0</td> </tr> <tr> <td>BACK HEIGHT: 16.0</td> <td>16.0</td> </tr> <tr> <td>COM: N/A</td> <td>N/A</td> </tr> <tr> <td>WEIGHT: 17.0 LB</td> <td>20.0 LB</td> </tr> </table>	ARMLESS	W/ ARMS	WIDTH: 21.5	25.5	DEPTH: 25.0	25.0	HEIGHT: 42.0	42.0	SEAT WIDTH: 19.5	19.5	SEAT DEPTH: 17.0	17.0	SEAT HEIGHT: 27.0	27.0	BACK WIDTH: 20.0	20.0	BACK HEIGHT: 16.0	16.0	COM: N/A	N/A	WEIGHT: 17.0 LB	20.0 LB	<p>G8 \$20</p> <p>Self-Leveling Metal Glide 4 per set Not Available on ST30 Stool, 1215 and 1265 models</p> <p>G9 \$30</p> <p>Self-Leveling VCT Glide 4 per set Not Available on ST30 Stool, 1215 and 1265 models</p> <p>G10 \$30</p> <p>Self-Leveling Felt Glide 4 per set Not Available on ST30 Stool, 1215 and 1265 models</p> <p>DL1 \$250</p> <p>Stacking Dolly Stacks Chairs 10 High four legs only</p>
ARMLESS	W/ ARMS																													
WIDTH: 21.5	25.5																													
DEPTH: 25.0	25.0																													
HEIGHT: 42.0	42.0																													
SEAT WIDTH: 19.5	19.5																													
SEAT DEPTH: 17.0	17.0																													
SEAT HEIGHT: 27.0	27.0																													
BACK WIDTH: 20.0	20.0																													
BACK HEIGHT: 16.0	16.0																													
COM: N/A	N/A																													
WEIGHT: 17.0 LB	20.0 LB																													
1265	GT	GUEST STACKING WITH CASTERS Mesh back with plastic seat.	M1 M1 M1 M2/M3 M2/M3 M2/M3	ARMLESS A18B A18G ARMLESS A18B A18G	P 355 400 400 385 430 430	<ul style="list-style-type: none"> • 50mm Hooded Casters • Stack 4 High on Floor • Stacks 10 High on Optional Dolly • Wall Saver Back Legs • Rated for 300 lbs 	<table border="1"> <tr> <th>ARMLESS</th> <th>W/ ARMS</th> </tr> <tr> <td>WIDTH: 21.5</td> <td>25.5</td> </tr> <tr> <td>DEPTH: 25.0</td> <td>25.0</td> </tr> <tr> <td>HEIGHT: 45.0</td> <td>45.0</td> </tr> <tr> <td>SEAT WIDTH: 19.5</td> <td>19.5</td> </tr> <tr> <td>SEAT DEPTH: 17.0</td> <td>17.0</td> </tr> <tr> <td>SEAT HEIGHT: 30.0</td> <td>30.0</td> </tr> <tr> <td>BACK WIDTH: 20.0</td> <td>20.0</td> </tr> <tr> <td>BACK HEIGHT: 16.0</td> <td>16.0</td> </tr> <tr> <td>COM: N/A</td> <td>N/A</td> </tr> <tr> <td>WEIGHT: 17.0 LB</td> <td>20.0 LB</td> </tr> </table>	ARMLESS	W/ ARMS	WIDTH: 21.5	25.5	DEPTH: 25.0	25.0	HEIGHT: 45.0	45.0	SEAT WIDTH: 19.5	19.5	SEAT DEPTH: 17.0	17.0	SEAT HEIGHT: 30.0	30.0	BACK WIDTH: 20.0	20.0	BACK HEIGHT: 16.0	16.0	COM: N/A	N/A	WEIGHT: 17.0 LB	20.0 LB	<p>GC1 \$30</p> <p>GC2 \$30</p> <p>Ganging Clip - 2 per set GC1 - Armless-to-Armless GC2 - Arm-to-Arm</p> <p>BRK \$70</p> <p>Book Rack in Black Only Available on All Models *Not Stackable with BRK</p>
ARMLESS	W/ ARMS																													
WIDTH: 21.5	25.5																													
DEPTH: 25.0	25.0																													
HEIGHT: 45.0	45.0																													
SEAT WIDTH: 19.5	19.5																													
SEAT DEPTH: 17.0	17.0																													
SEAT HEIGHT: 30.0	30.0																													
BACK WIDTH: 20.0	20.0																													
BACK HEIGHT: 16.0	16.0																													
COM: N/A	N/A																													
WEIGHT: 17.0 LB	20.0 LB																													

NOTE: TLF AND TRF REQUIRE SOME ASSEMBLY

NOTE: ALL MESH STYLE AVAILABLE IN M1, M2 AND M3

NOTE: ALL MESH STYLE AVAILABLE IN M1, M2 AND M3

*Standard twenty five (25) business days applies only to Metallic Brown, Gunmetal, Dover Gray and White frame color options.

CAUTION: Careless stacking of chairs may scratch and damage frames. 9to5 Seating does not warrant scratched frames of stacking chairs.

shuttle

the ultimate utility chair

UPHOLSTERED SEAT - US

GSA SIN # 711-19

- Seat and back styles include: all plastic, upholstered seat w/ plastic back or fully upholstered seat and back
- Bariatric, stools and tablet models available
- 11 plastic colors, 6 frame finishes
- Wall saver design on model 1210 and 1260
- Warranted up to 300 lbs
- CAL TB 133 Fire Code approved



CREATING SHUTTLE MODEL NUMBER

MODEL NUMBER CONTROL ARMS FRAME COLOR UPHOLSTERY MESH COLOR PLASTIC COLOR GRADE CASTERS PACKAGING

1 2 - G T - A - U S - M - P - - - - -

* FOR ARMLESS CODE USE ADD * ONLY SELECT CASTER CODE FOR MODEL 1215,1265

FRAME COLORS

BLACK BF	SILVER SF	METALLIC BROWN* MBF
GUNMETAL* GMF	DOVER GRAY* DGF	WHITE* WF

PACKAGING NOTES

CODE	DESCRIPTION	LIST UPCHARGE
AB	ASSEMBLED IN BAG FOR WILL CALL	\$0
AC	ASSEMBLED IN CARTON	\$0

SHUTTLE SIDE CHAIRS SHIP UP TO 3 PER CARTON

NOTE: Due to the nature of vinyl upholstery, stacking may cause impressions on the seat. 9to5 Seating does not warrant the effects of the stacking on vinyl upholstery.

MODEL	CONTROL	DESCRIPTION	MESH	ARM	FABRIC	FEATURES	DIMENSIONS	ARM OPTIONS	CASTER OPTIONS																																																																							
1210	GT	GUEST STACKING Plastic back with upholstered seat.		ARMLESS	<table border="1"> <thead> <tr><th>A/COM</th><th>B</th><th>C</th><th>D</th><th>E</th><th>F</th><th>G</th></tr> </thead> <tbody> <tr><td>310</td><td>335</td><td>355</td><td>380</td><td>410</td><td>445</td><td>480</td></tr> <tr><td>355</td><td>380</td><td>400</td><td>425</td><td>455</td><td>490</td><td>525</td></tr> <tr><td>A18G</td><td>355</td><td>380</td><td>400</td><td>425</td><td>455</td><td>490</td></tr> <tr><td>TLF/TRF</td><td>460</td><td>485</td><td>505</td><td>530</td><td>560</td><td>595</td></tr> <tr><td>OS</td><td>460</td><td>485</td><td>505</td><td>530</td><td>560</td><td>595</td></tr> </tbody> </table>	A/COM	B	C	D	E	F	G	310	335	355	380	410	445	480	355	380	400	425	455	490	525	A18G	355	380	400	425	455	490	TLF/TRF	460	485	505	530	560	595	OS	460	485	505	530	560	595	<ul style="list-style-type: none"> • Non-Marring Floor Glides • Stack 4 High on Floor • Stacks 10 High on Optional Dolly • Wall Saver Back Legs • Rated for 300 lbs 	<table border="1"> <thead> <tr><th>ARMLESS</th><th>W/ ARMS</th></tr> </thead> <tbody> <tr><td>WIDTH:</td><td>21.5 25.5</td></tr> <tr><td>DEPTH:</td><td>25.0 25.0</td></tr> <tr><td>HEIGHT:</td><td>33.0 33.0</td></tr> <tr><td>SEAT WIDTH:</td><td>19.5 19.5</td></tr> <tr><td>SEAT DEPTH:</td><td>17.0 17.0</td></tr> <tr><td>SEAT HEIGHT:</td><td>17.0 17.0</td></tr> <tr><td>BACK WIDTH:</td><td>20.0 20.0</td></tr> <tr><td>BACK HEIGHT:</td><td>16.0 16.0</td></tr> <tr><td>COM:</td><td>0.8 YDS 0.8 YDS</td></tr> <tr><td>WEIGHT:</td><td>19.0 LB 22.0 LB</td></tr> </tbody> </table>	ARMLESS	W/ ARMS	WIDTH:	21.5 25.5	DEPTH:	25.0 25.0	HEIGHT:	33.0 33.0	SEAT WIDTH:	19.5 19.5	SEAT DEPTH:	17.0 17.0	SEAT HEIGHT:	17.0 17.0	BACK WIDTH:	20.0 20.0	BACK HEIGHT:	16.0 16.0	COM:	0.8 YDS 0.8 YDS	WEIGHT:	19.0 LB 22.0 LB	<p>A18B \$45 A18G \$45</p> <p>Soft Touch Polyurethane Arms - Black or Gray Color</p> <p>OS \$190</p> <p>Left or Right OverSize Tablet *Not Stackable with Tablet</p>	<p>C5 STD C5S \$30</p> <p>Standard 50mm Hooded Casters 50mm Hooded Hard Floor Casters</p>							
A/COM	B		C	D	E	F	G																																																																									
310	335		355	380	410	445	480																																																																									
355	380		400	425	455	490	525																																																																									
A18G	355	380	400	425	455	490																																																																										
TLF/TRF	460	485	505	530	560	595																																																																										
OS	460	485	505	530	560	595																																																																										
ARMLESS	W/ ARMS																																																																															
WIDTH:	21.5 25.5																																																																															
DEPTH:	25.0 25.0																																																																															
HEIGHT:	33.0 33.0																																																																															
SEAT WIDTH:	19.5 19.5																																																																															
SEAT DEPTH:	17.0 17.0																																																																															
SEAT HEIGHT:	17.0 17.0																																																																															
BACK WIDTH:	20.0 20.0																																																																															
BACK HEIGHT:	16.0 16.0																																																																															
COM:	0.8 YDS 0.8 YDS																																																																															
WEIGHT:	19.0 LB 22.0 LB																																																																															
	A18B																																																																															
	A18G																																																																															
	TLF/TRF																																																																															
						NOTE: TLF AND TRF REQUIRE SOME ASSEMBLY																																																																										
1215	GT	GUEST STACKING WITH CASTERS Plastic back with upholstered seat.		ARMLESS	<table border="1"> <thead> <tr><th>A/COM</th><th>B</th><th>C</th><th>D</th><th>E</th><th>F</th><th>G</th></tr> </thead> <tbody> <tr><td>355</td><td>380</td><td>400</td><td>425</td><td>455</td><td>490</td><td>525</td></tr> <tr><td>A18B</td><td>400</td><td>425</td><td>445</td><td>470</td><td>500</td><td>535</td></tr> <tr><td>A18G</td><td>400</td><td>425</td><td>445</td><td>470</td><td>500</td><td>535</td></tr> </tbody> </table>	A/COM	B	C	D	E	F	G	355	380	400	425	455	490	525	A18B	400	425	445	470	500	535	A18G	400	425	445	470	500	535	<ul style="list-style-type: none"> • 50mm Hooded Casters • Stack 4 High on Floor • Stacks 10 High on Optional Dolly • Rated for 300 lbs 	<table border="1"> <thead> <tr><th>ARMLESS</th><th>W/ ARMS</th></tr> </thead> <tbody> <tr><td>WIDTH:</td><td>21.5 25.5</td></tr> <tr><td>DEPTH:</td><td>25.0 25.0</td></tr> <tr><td>HEIGHT:</td><td>33.0 33.0</td></tr> <tr><td>SEAT WIDTH:</td><td>19.5 19.5</td></tr> <tr><td>SEAT DEPTH:</td><td>17.0 17.0</td></tr> <tr><td>SEAT HEIGHT:</td><td>17.0 17.0</td></tr> <tr><td>BACK WIDTH:</td><td>20.0 20.0</td></tr> <tr><td>BACK HEIGHT:</td><td>16.0 16.0</td></tr> <tr><td>COM:</td><td>0.8 YDS 0.8 YDS</td></tr> <tr><td>WEIGHT:</td><td>19.0 LB 22.0 LB</td></tr> </tbody> </table>	ARMLESS	W/ ARMS	WIDTH:	21.5 25.5	DEPTH:	25.0 25.0	HEIGHT:	33.0 33.0	SEAT WIDTH:	19.5 19.5	SEAT DEPTH:	17.0 17.0	SEAT HEIGHT:	17.0 17.0	BACK WIDTH:	20.0 20.0	BACK HEIGHT:	16.0 16.0	COM:	0.8 YDS 0.8 YDS	WEIGHT:	19.0 LB 22.0 LB	<p>TLF \$150 TRF \$150</p> <p>Left Folding Tablet Arm in Black Laminate. Available with Black Frame only *Not Stackable with Tablet</p> <p>Right Folding Tablet Arm in Black Laminate. Available with Black Frame only *Not Stackable with Tablet</p>	<p>C5S \$30</p> <p>50mm Hooded Hard Floor Casters</p>																					
A/COM	B		C	D	E	F	G																																																																									
355	380		400	425	455	490	525																																																																									
A18B	400		425	445	470	500	535																																																																									
A18G	400	425	445	470	500	535																																																																										
ARMLESS	W/ ARMS																																																																															
WIDTH:	21.5 25.5																																																																															
DEPTH:	25.0 25.0																																																																															
HEIGHT:	33.0 33.0																																																																															
SEAT WIDTH:	19.5 19.5																																																																															
SEAT DEPTH:	17.0 17.0																																																																															
SEAT HEIGHT:	17.0 17.0																																																																															
BACK WIDTH:	20.0 20.0																																																																															
BACK HEIGHT:	16.0 16.0																																																																															
COM:	0.8 YDS 0.8 YDS																																																																															
WEIGHT:	19.0 LB 22.0 LB																																																																															
	A18B																																																																															
	A18G																																																																															
1260	GT	GUEST STACKING Mesh back with upholstered seat.	M1	ARMLESS	<table border="1"> <thead> <tr><th>A/COM</th><th>B</th><th>C</th><th>D</th><th>E</th><th>F</th><th>G</th></tr> </thead> <tbody> <tr><td>375</td><td>400</td><td>420</td><td>445</td><td>475</td><td>510</td><td>545</td></tr> <tr><td>M1</td><td>420</td><td>445</td><td>465</td><td>490</td><td>520</td><td>555</td></tr> <tr><td>M1</td><td>420</td><td>445</td><td>465</td><td>490</td><td>520</td><td>555</td></tr> <tr><td>M2/M3</td><td>405</td><td>430</td><td>450</td><td>475</td><td>505</td><td>540</td></tr> <tr><td>M2/M3</td><td>450</td><td>475</td><td>495</td><td>520</td><td>550</td><td>585</td></tr> <tr><td>M2/M3</td><td>450</td><td>475</td><td>495</td><td>520</td><td>550</td><td>585</td></tr> </tbody> </table>	A/COM	B	C	D	E	F	G	375	400	420	445	475	510	545	M1	420	445	465	490	520	555	M1	420	445	465	490	520	555	M2/M3	405	430	450	475	505	540	M2/M3	450	475	495	520	550	585	M2/M3	450	475	495	520	550	585	<ul style="list-style-type: none"> • Non-Marring Floor Glides • Stack 4 High on Floor • Stacks 10 High on Optional Dolly • Wall Saver Back Legs • Rated for 300 lbs 	<table border="1"> <thead> <tr><th>ARMLESS</th><th>W/ ARMS</th></tr> </thead> <tbody> <tr><td>WIDTH:</td><td>21.5 25.5</td></tr> <tr><td>DEPTH:</td><td>25.0 25.0</td></tr> <tr><td>HEIGHT:</td><td>42.0 33.0</td></tr> <tr><td>SEAT WIDTH:</td><td>19.5 19.5</td></tr> <tr><td>SEAT DEPTH:</td><td>17.0 17.0</td></tr> <tr><td>SEAT HEIGHT:</td><td>27.0 17.0</td></tr> <tr><td>BACK WIDTH:</td><td>20.0 20.0</td></tr> <tr><td>BACK HEIGHT:</td><td>16.0 16.0</td></tr> <tr><td>COM:</td><td>0.8 YDS 0.8 YDS</td></tr> <tr><td>WEIGHT:</td><td>19.0 LB 22.0 LB</td></tr> </tbody> </table>	ARMLESS	W/ ARMS	WIDTH:	21.5 25.5	DEPTH:	25.0 25.0	HEIGHT:	42.0 33.0	SEAT WIDTH:	19.5 19.5	SEAT DEPTH:	17.0 17.0	SEAT HEIGHT:	27.0 17.0	BACK WIDTH:	20.0 20.0	BACK HEIGHT:	16.0 16.0	COM:	0.8 YDS 0.8 YDS	WEIGHT:	19.0 LB 22.0 LB	<p>G8 \$20 G9 \$30 G10 \$30</p> <p>Self-Leveling Metal Glide 4 per set Not Available on ST30 Stool, 1215 and 1265 models</p> <p>Self-Leveling VCT Glide 4 per set Not Available on ST30 Stool, 1215 and 1265 models</p> <p>Self-Leveling Felt Glide 4 per set Not Available on ST30 Stool, 1215 and 1265 models</p> <p>EF1 \$30 MF1 \$50</p> <p>EF1 - 1" Extra Foam on Seat MF1 - 1" Visco Elastic Memory Foam on Seat</p>	<p>DL1 \$250 GC1 \$30 GC2 \$30</p> <p>Stacking Dolly Stacks Chairs 10 High four legs only</p> <p>Ganging Clip - 2 per set GC1 - Armless-to-Armless GC2 - Arm-to-Arm</p>
A/COM	B		C	D	E	F	G																																																																									
375	400		420	445	475	510	545																																																																									
M1	420		445	465	490	520	555																																																																									
M1	420		445	465	490	520	555																																																																									
M2/M3	405		430	450	475	505	540																																																																									
M2/M3	450	475	495	520	550	585																																																																										
M2/M3	450	475	495	520	550	585																																																																										
ARMLESS	W/ ARMS																																																																															
WIDTH:	21.5 25.5																																																																															
DEPTH:	25.0 25.0																																																																															
HEIGHT:	42.0 33.0																																																																															
SEAT WIDTH:	19.5 19.5																																																																															
SEAT DEPTH:	17.0 17.0																																																																															
SEAT HEIGHT:	27.0 17.0																																																																															
BACK WIDTH:	20.0 20.0																																																																															
BACK HEIGHT:	16.0 16.0																																																																															
COM:	0.8 YDS 0.8 YDS																																																																															
WEIGHT:	19.0 LB 22.0 LB																																																																															
	M1	A18B																																																																														
	M1	A18G																																																																														
	M2/M3	ARMLESS																																																																														
	M2/M3	A18B																																																																														
	M2/M3	A18G																																																																														
						NOTE: ALL MESH STYLE AVAILABLE IN M1, M2 AND M3																																																																										
1265	GT	GUEST STACKING WITH CASTERS Mesh back with upholstered seat.	M1	ARMLESS	<table border="1"> <thead> <tr><th>A/COM</th><th>B</th><th>C</th><th>D</th><th>E</th><th>F</th><th>G</th></tr> </thead> <tbody> <tr><td>420</td><td>445</td><td>465</td><td>490</td><td>520</td><td>555</td><td>590</td></tr> <tr><td>M1</td><td>465</td><td>490</td><td>510</td><td>535</td><td>565</td><td>600</td></tr> <tr><td>M1</td><td>465</td><td>490</td><td>510</td><td>535</td><td>565</td><td>600</td></tr> <tr><td>M2/M3</td><td>450</td><td>475</td><td>495</td><td>520</td><td>550</td><td>585</td></tr> <tr><td>M2/M3</td><td>495</td><td>520</td><td>540</td><td>565</td><td>595</td><td>630</td></tr> <tr><td>M2/M3</td><td>495</td><td>520</td><td>540</td><td>565</td><td>595</td><td>630</td></tr> </tbody> </table>	A/COM	B	C	D	E	F	G	420	445	465	490	520	555	590	M1	465	490	510	535	565	600	M1	465	490	510	535	565	600	M2/M3	450	475	495	520	550	585	M2/M3	495	520	540	565	595	630	M2/M3	495	520	540	565	595	630	<ul style="list-style-type: none"> • 50mm Hooded Casters • Stack 4 High on Floor • Stacks 10 High on Optional Dolly • Rated for 300 lbs 	<table border="1"> <thead> <tr><th>ARMLESS</th><th>W/ ARMS</th></tr> </thead> <tbody> <tr><td>WIDTH:</td><td>21.5 25.5</td></tr> <tr><td>DEPTH:</td><td>25.0 25.0</td></tr> <tr><td>HEIGHT:</td><td>45.0 45.0</td></tr> <tr><td>SEAT WIDTH:</td><td>19.5 19.5</td></tr> <tr><td>SEAT DEPTH:</td><td>17.0 17.0</td></tr> <tr><td>SEAT HEIGHT:</td><td>30.0 30.0</td></tr> <tr><td>BACK WIDTH:</td><td>20.0 20.0</td></tr> <tr><td>BACK HEIGHT:</td><td>16.0 16.0</td></tr> <tr><td>COM:</td><td>0.8 YDS 0.8 YDS</td></tr> <tr><td>WEIGHT:</td><td>19.0 LB 22.0 LB</td></tr> </tbody> </table>	ARMLESS	W/ ARMS	WIDTH:	21.5 25.5	DEPTH:	25.0 25.0	HEIGHT:	45.0 45.0	SEAT WIDTH:	19.5 19.5	SEAT DEPTH:	17.0 17.0	SEAT HEIGHT:	30.0 30.0	BACK WIDTH:	20.0 20.0	BACK HEIGHT:	16.0 16.0	COM:	0.8 YDS 0.8 YDS	WEIGHT:	19.0 LB 22.0 LB	<p>BRK \$70</p> <p>Book Rack in Black Only Available on All Models *Not Stackable with BRK</p>	
A/COM	B		C	D	E	F	G																																																																									
420	445		465	490	520	555	590																																																																									
M1	465		490	510	535	565	600																																																																									
M1	465		490	510	535	565	600																																																																									
M2/M3	450		475	495	520	550	585																																																																									
M2/M3	495	520	540	565	595	630																																																																										
M2/M3	495	520	540	565	595	630																																																																										
ARMLESS	W/ ARMS																																																																															
WIDTH:	21.5 25.5																																																																															
DEPTH:	25.0 25.0																																																																															
HEIGHT:	45.0 45.0																																																																															
SEAT WIDTH:	19.5 19.5																																																																															
SEAT DEPTH:	17.0 17.0																																																																															
SEAT HEIGHT:	30.0 30.0																																																																															
BACK WIDTH:	20.0 20.0																																																																															
BACK HEIGHT:	16.0 16.0																																																																															
COM:	0.8 YDS 0.8 YDS																																																																															
WEIGHT:	19.0 LB 22.0 LB																																																																															
	M1	A18B																																																																														
	M1	A18G																																																																														
	M2/M3	ARMLESS																																																																														
	M2/M3	A18B																																																																														
	M2/M3	A18G																																																																														
						NOTE: ALL MESH STYLE AVAILABLE IN M1, M2 AND M3																																																																										

*Standard twenty five (25) business days applies only to Metallic Brown, Gunmetal, Dover Gray and White frame color options.

CAUTION: Careless stacking of chairs may scratch and damage frames. 9to5 Seating does not warrant scratched frames of stacking chairs.

shuttle

the ultimate utility chair

FULLY UPHOLSTERED - UP

GSA SIN # 711-19

- Seat and back styles include: all plastic, upholstered seat w/ plastic back or fully upholstered seat and back
- Bariatric, stools and tablet models available
- 6 powder coated frame finishes
- Wall saver design on model 1210 and 1260
- Warranted up to 300 lbs
- CAL TB 133 Fire Code approved



CREATING SHUTTLE MODEL NUMBER

MODEL NUMBER CONTROL ARMS FRAME COLOR UPHOLSTERY GRADE CASTERS PACKAGING

1 2 0 0 - G T - A 0 0 - 0 0 0 - U P - 0 0 0 0 - 0 0 0

* FOR ARMLESS CODE USE A00 * ONLY SELECT CASTER CODE FOR MODEL 1215

FRAME COLORS

BLACK BF	SILVER SF	METALLIC BROWN* MBF
GUNMETAL* GMF	DOVER GRAY* DGF	WHITE* WF

PACKAGING NOTES

CODE	DESCRIPTION	LIST UPCHARGE
AB	ASSEMBLED IN BAG FOR WILL CALL	\$0
AC	ASSEMBLED IN CARTON	\$0

SHUTTLE SIDE CHAIRS SHIP UP TO 3 PER CARTON

NOTE: Due to the nature of vinyl upholstery, stacking may cause impressions on the seat. 9to5 Seating does not warrant the effects of the stacking on vinyl upholstery.

MODEL	CONTROL	DESCRIPTION	MESH	ARM	FABRIC	FEATURES	DIMENSIONS	ARM OPTIONS	CASTER OPTIONS																																																															
1210	GT	GUEST STACKING Fully upholstered back and seat.		ARMLESS A18B A18G TLF/TRF OS	<table border="1"> <thead> <tr> <th>A/COM</th> <th>B</th> <th>C</th> <th>D</th> <th>E</th> <th>F</th> <th>G</th> </tr> </thead> <tbody> <tr> <td>335</td> <td>375</td> <td>400</td> <td>440</td> <td>485</td> <td>535</td> <td>590</td> </tr> <tr> <td>380</td> <td>420</td> <td>445</td> <td>485</td> <td>530</td> <td>580</td> <td>635</td> </tr> <tr> <td>380</td> <td>420</td> <td>445</td> <td>485</td> <td>530</td> <td>580</td> <td>635</td> </tr> <tr> <td>485</td> <td>525</td> <td>550</td> <td>590</td> <td>635</td> <td>685</td> <td>740</td> </tr> <tr> <td>485</td> <td>525</td> <td>550</td> <td>590</td> <td>635</td> <td>685</td> <td>740</td> </tr> </tbody> </table>	A/COM	B	C	D	E	F	G	335	375	400	440	485	535	590	380	420	445	485	530	580	635	380	420	445	485	530	580	635	485	525	550	590	635	685	740	485	525	550	590	635	685	740	<ul style="list-style-type: none"> • Non-Marring Floor Glides • Stack 4 High on Floor • Stacks 10 High on Optional Dolly • Wall Saver Back Legs • Rated for 300 lbs 	<table border="1"> <thead> <tr> <th>ARMLESS</th> <th>W/ ARMS</th> </tr> </thead> <tbody> <tr> <td>WIDTH: 21.5</td> <td>25.5</td> </tr> <tr> <td>DEPTH: 25.0</td> <td>25.0</td> </tr> <tr> <td>HEIGHT: 33.0</td> <td>33.0</td> </tr> <tr> <td>SEAT WIDTH: 19.5</td> <td>19.5</td> </tr> <tr> <td>SEAT DEPTH: 17.0</td> <td>17.0</td> </tr> <tr> <td>SEAT HEIGHT: 17.0</td> <td>17.0</td> </tr> <tr> <td>BACK WIDTH: 20.0</td> <td>20.0</td> </tr> <tr> <td>BACK HEIGHT: 16.0</td> <td>16.0</td> </tr> <tr> <td>COM: 1.2 YDS</td> <td>1.2 YDS</td> </tr> <tr> <td>WEIGHT: 21.0 LB</td> <td>24.0 LB</td> </tr> </tbody> </table>	ARMLESS	W/ ARMS	WIDTH: 21.5	25.5	DEPTH: 25.0	25.0	HEIGHT: 33.0	33.0	SEAT WIDTH: 19.5	19.5	SEAT DEPTH: 17.0	17.0	SEAT HEIGHT: 17.0	17.0	BACK WIDTH: 20.0	20.0	BACK HEIGHT: 16.0	16.0	COM: 1.2 YDS	1.2 YDS	WEIGHT: 21.0 LB	24.0 LB	<p>A18B \$45 Soft Touch Polyurethane Arms - Black or Gray Color</p> <p>A18G \$45 Soft Touch Polyurethane Arms - Black or Gray Color</p> <p>OS \$190 Left or Right OverSize Tablet *Not Stackable with Tablet</p> <p>TLF \$150 Left Folding Tablet Arm in Black Laminate. Available with Black Frame only *Not Stackable with Tablet</p> <p>TRF \$150 Right Folding Tablet Arm in Black Laminate. Available with Black Frame only *Not Stackable with Tablet</p> <p>C5 STD Standard 50mm Hooded Casters</p> <p>C5S \$30 50mm Hooded Hard Floor Casters</p>
A/COM	B	C	D	E	F	G																																																																		
335	375	400	440	485	535	590																																																																		
380	420	445	485	530	580	635																																																																		
380	420	445	485	530	580	635																																																																		
485	525	550	590	635	685	740																																																																		
485	525	550	590	635	685	740																																																																		
ARMLESS	W/ ARMS																																																																							
WIDTH: 21.5	25.5																																																																							
DEPTH: 25.0	25.0																																																																							
HEIGHT: 33.0	33.0																																																																							
SEAT WIDTH: 19.5	19.5																																																																							
SEAT DEPTH: 17.0	17.0																																																																							
SEAT HEIGHT: 17.0	17.0																																																																							
BACK WIDTH: 20.0	20.0																																																																							
BACK HEIGHT: 16.0	16.0																																																																							
COM: 1.2 YDS	1.2 YDS																																																																							
WEIGHT: 21.0 LB	24.0 LB																																																																							
1215	GT	GUEST STACKING WITH CASTERS Fully upholstered back and seat.		ARMLESS A18B A18G	<table border="1"> <thead> <tr> <th>A/COM</th> <th>B</th> <th>C</th> <th>D</th> <th>E</th> <th>F</th> <th>G</th> </tr> </thead> <tbody> <tr> <td>380</td> <td>420</td> <td>445</td> <td>485</td> <td>530</td> <td>580</td> <td>635</td> </tr> <tr> <td>425</td> <td>465</td> <td>490</td> <td>530</td> <td>575</td> <td>625</td> <td>680</td> </tr> <tr> <td>425</td> <td>465</td> <td>490</td> <td>530</td> <td>575</td> <td>625</td> <td>680</td> </tr> </tbody> </table>	A/COM	B	C	D	E	F	G	380	420	445	485	530	580	635	425	465	490	530	575	625	680	425	465	490	530	575	625	680	<ul style="list-style-type: none"> • 50mm Hooded Casters • Stack 4 High on Floor • Stacks 10 High on Optional Dolly • Rated for 300 lbs 	<table border="1"> <thead> <tr> <th>ARMLESS</th> <th>W/ ARMS</th> </tr> </thead> <tbody> <tr> <td>WIDTH: 21.5</td> <td>25.5</td> </tr> <tr> <td>DEPTH: 25.0</td> <td>25.0</td> </tr> <tr> <td>HEIGHT: 33.0</td> <td>33.0</td> </tr> <tr> <td>SEAT WIDTH: 19.5</td> <td>19.5</td> </tr> <tr> <td>SEAT DEPTH: 17.0</td> <td>17.0</td> </tr> <tr> <td>SEAT HEIGHT: 17.0</td> <td>17.0</td> </tr> <tr> <td>BACK WIDTH: 20.0</td> <td>20.0</td> </tr> <tr> <td>BACK HEIGHT: 16.0</td> <td>16.0</td> </tr> <tr> <td>COM: 1.2 YDS</td> <td>1.2 YDS</td> </tr> <tr> <td>WEIGHT: 21.0 LB</td> <td>24.0 LB</td> </tr> </tbody> </table>	ARMLESS	W/ ARMS	WIDTH: 21.5	25.5	DEPTH: 25.0	25.0	HEIGHT: 33.0	33.0	SEAT WIDTH: 19.5	19.5	SEAT DEPTH: 17.0	17.0	SEAT HEIGHT: 17.0	17.0	BACK WIDTH: 20.0	20.0	BACK HEIGHT: 16.0	16.0	COM: 1.2 YDS	1.2 YDS	WEIGHT: 21.0 LB	24.0 LB	<p>G8 \$20 Self-Leveling Metal Glide 4 per set Not Available on ST30 Stool, 1215 and 1265 models</p> <p>G9 \$30 Self-Leveling VCT Glide 4 per set Not Available on ST30 Stool, 1215 and 1265 models</p> <p>G10 \$30 Self-Leveling Felt Glide 4 per set Not Available on ST30 Stool, 1215 and 1265 models</p> <p>BN1 \$35 BN2 \$0 Black Ballistic Nylon Back BN1 w/ Grad A Fabrics BN2 w/ Grade B and Up</p> <p>EF1 \$30 MF1 \$50 EF1 - 1" Extra Foam on Seat MF1 - 1" Visco Elastic Memory Foam on Seat</p> <p>DL1 \$250 Stacking Dolly Stack Chair 10 High four legs only</p> <p>GC1 \$30 GC2 \$30 Ganging Clip - 2 per set GC1 - Armless-to-Armless GC2 - Arm-to-Arm</p> <p>BRK \$70 Book Rack in Black Only Available on All Models *Not Stackable with BRK</p>														
A/COM	B	C	D	E	F	G																																																																		
380	420	445	485	530	580	635																																																																		
425	465	490	530	575	625	680																																																																		
425	465	490	530	575	625	680																																																																		
ARMLESS	W/ ARMS																																																																							
WIDTH: 21.5	25.5																																																																							
DEPTH: 25.0	25.0																																																																							
HEIGHT: 33.0	33.0																																																																							
SEAT WIDTH: 19.5	19.5																																																																							
SEAT DEPTH: 17.0	17.0																																																																							
SEAT HEIGHT: 17.0	17.0																																																																							
BACK WIDTH: 20.0	20.0																																																																							
BACK HEIGHT: 16.0	16.0																																																																							
COM: 1.2 YDS	1.2 YDS																																																																							
WEIGHT: 21.0 LB	24.0 LB																																																																							

NOTE: TLF AND TRF REQUIRE SOME ASSEMBLY

*Standard twenty five (25) business days applies only to Metallic Brown, Gunmetal, Dover Gray and White frame color options.

CAUTION: Careless stacking of chairs may scratch and damage frames. 9to5 Seating does not warrant scratched frames of stacking chairs.

shuttle

the ultimate utility chair

ALL PLASTIC - AP

GSA SIN # 711-19

- Seat and back styles include: all plastic, upholstered seat w/ plastic back or fully upholstered seat and back
- Bariatric, stools and tablet models available
- 11 plastic colors, 6 frame finishes
- Wall saver design on model 1210 and 1260
- Warranted up to 300 lbs
- CAL TB 133 Fire Code approved
- Three Seat Height Choices



CREATING SHUTTLE MODEL NUMBER

MODEL NUMBER CONTROL ARMS FRAME COLOR UPHOLSTERY PLASTIC COLOR GRADE CASTERS PACKAGING

1 2 - S T - A - A P - P - P - - -

* FOR ARMLESS CODE USE ADD * ONLY SELECT CASTER CODE FOR MODEL 1215

FRAME COLORS

BLACK BF	SILVER SF	METALLIC BROWN* MBF
GUNMETAL* GMF	DOVER GRAY* DGF	WHITE* WF

PACKAGING NOTES

CODE	DESCRIPTION	LIST UPCHARGE
AB	ASSEMBLED IN BAG FOR WILL CALL	\$0
AC	ASSEMBLED IN CARTON	\$0

SHUTTLE SIDE CHAIRS SHIP UP TO 3 PER CARTON

MODEL	CONTROL	DESCRIPTION	MESH	ARM	PLASTIC	FEATURES	DIMENSIONS	ARM OPTIONS	ADDITIONAL OPTIONS	ACCESSORIES																																	
NEW MODEL 1210	ST24	24" STOOL Plastic back and seat. Use for work surfaces up to 34 inches high.		ARMLESS A18B A18G	P 375 420 420	<ul style="list-style-type: none"> • Non-Marring Floor Glides • Foot rest • Rated for 300 lbs 	<table border="1"> <thead> <tr> <th></th> <th>ARMLESS</th> <th>W/ ARMS</th> </tr> </thead> <tbody> <tr><td>WIDTH:</td><td>21.5</td><td>25.5</td></tr> <tr><td>DEPTH:</td><td>25.0</td><td>25.0</td></tr> <tr><td>HEIGHT:</td><td>39.0</td><td>39.0</td></tr> <tr><td>SEAT WIDTH:</td><td>19.5</td><td>19.5</td></tr> <tr><td>SEAT DEPTH:</td><td>17.0</td><td>17.0</td></tr> <tr><td>SEAT HEIGHT:</td><td>24.0</td><td>24.0</td></tr> <tr><td>BACK WIDTH:</td><td>20.0</td><td>20.0</td></tr> <tr><td>BACK HEIGHT:</td><td>16.0</td><td>16.0</td></tr> <tr><td>COM:</td><td>N/A</td><td>N/A</td></tr> <tr><td>WEIGHT:</td><td>21.5 LB</td><td>24.5 LB</td></tr> </tbody> </table>		ARMLESS	W/ ARMS	WIDTH:	21.5	25.5	DEPTH:	25.0	25.0	HEIGHT:	39.0	39.0	SEAT WIDTH:	19.5	19.5	SEAT DEPTH:	17.0	17.0	SEAT HEIGHT:	24.0	24.0	BACK WIDTH:	20.0	20.0	BACK HEIGHT:	16.0	16.0	COM:	N/A	N/A	WEIGHT:	21.5 LB	24.5 LB	<p>A18B A18G \$45</p> <p>Soft Touch Polyurethane Arms - Black or Gray Color</p>	<p>G8 \$20 G9 \$30 G10 \$30</p> <p>Self-Leveling Metal Glide 4 per set Not Available on ST30 Stool, 1215 and 1265 models</p> <p>Self-Leveling VCT Glide 4 per set Not Available on ST30 Stool, 1215 and 1265 models</p> <p>Self-Leveling Felt Glide 4 per set Not Available on ST30 Stool, 1215 and 1265 models</p>	<p>GC1 \$30 GC2 \$30</p> <p>Ganging Clip - 2 per set GC1 - Armless-to-Armless GC2 - Arm-to-Arm</p>
	ARMLESS	W/ ARMS																																									
WIDTH:	21.5	25.5																																									
DEPTH:	25.0	25.0																																									
HEIGHT:	39.0	39.0																																									
SEAT WIDTH:	19.5	19.5																																									
SEAT DEPTH:	17.0	17.0																																									
SEAT HEIGHT:	24.0	24.0																																									
BACK WIDTH:	20.0	20.0																																									
BACK HEIGHT:	16.0	16.0																																									
COM:	N/A	N/A																																									
WEIGHT:	21.5 LB	24.5 LB																																									
1210	ST27	27" STOOL Plastic back and seat. Use for work surfaces up to 36 inches high.		ARMLESS A18B A18G	P 375 420 420	<ul style="list-style-type: none"> • Non-Marring Floor Glides • Foot rest • Rated for 300 lbs 	<table border="1"> <thead> <tr> <th></th> <th>ARMLESS</th> <th>W/ ARMS</th> </tr> </thead> <tbody> <tr><td>WIDTH:</td><td>21.5</td><td>25.5</td></tr> <tr><td>DEPTH:</td><td>25.0</td><td>25.0</td></tr> <tr><td>HEIGHT:</td><td>42.0</td><td>42.0</td></tr> <tr><td>SEAT WIDTH:</td><td>19.5</td><td>19.5</td></tr> <tr><td>SEAT DEPTH:</td><td>17.0</td><td>17.0</td></tr> <tr><td>SEAT HEIGHT:</td><td>27.0</td><td>27.0</td></tr> <tr><td>BACK WIDTH:</td><td>20.0</td><td>20.0</td></tr> <tr><td>BACK HEIGHT:</td><td>16.0</td><td>16.0</td></tr> <tr><td>COM:</td><td>N/A</td><td>N/A</td></tr> <tr><td>WEIGHT:</td><td>22.5 LB</td><td>25.5 LB</td></tr> </tbody> </table>		ARMLESS	W/ ARMS	WIDTH:	21.5	25.5	DEPTH:	25.0	25.0	HEIGHT:	42.0	42.0	SEAT WIDTH:	19.5	19.5	SEAT DEPTH:	17.0	17.0	SEAT HEIGHT:	27.0	27.0	BACK WIDTH:	20.0	20.0	BACK HEIGHT:	16.0	16.0	COM:	N/A	N/A	WEIGHT:	22.5 LB	25.5 LB	<p>A18B A18G \$45</p> <p>Soft Touch Polyurethane Arms - Black or Gray Color</p>	<p>G8 \$20 G9 \$30 G10 \$30</p> <p>Self-Leveling Metal Glide 4 per set Not Available on ST30 Stool, 1215 and 1265 models</p> <p>Self-Leveling VCT Glide 4 per set Not Available on ST30 Stool, 1215 and 1265 models</p> <p>Self-Leveling Felt Glide 4 per set Not Available on ST30 Stool, 1215 and 1265 models</p>	<p>GC1 \$30 GC2 \$30</p> <p>Ganging Clip - 2 per set GC1 - Armless-to-Armless GC2 - Arm-to-Arm</p>
	ARMLESS	W/ ARMS																																									
WIDTH:	21.5	25.5																																									
DEPTH:	25.0	25.0																																									
HEIGHT:	42.0	42.0																																									
SEAT WIDTH:	19.5	19.5																																									
SEAT DEPTH:	17.0	17.0																																									
SEAT HEIGHT:	27.0	27.0																																									
BACK WIDTH:	20.0	20.0																																									
BACK HEIGHT:	16.0	16.0																																									
COM:	N/A	N/A																																									
WEIGHT:	22.5 LB	25.5 LB																																									
1210	ST30	30" STOOL Plastic back and seat. Use for work surfaces up to 42 inches high.		ARMLESS A18B A18G	P 395 440 440	<ul style="list-style-type: none"> • Non-Marring Floor Glides • Foot rest • Rated for 300 lbs 	<table border="1"> <thead> <tr> <th></th> <th>ARMLESS</th> <th>W/ ARMS</th> </tr> </thead> <tbody> <tr><td>WIDTH:</td><td>21.5</td><td>25.5</td></tr> <tr><td>DEPTH:</td><td>25.0</td><td>25.0</td></tr> <tr><td>HEIGHT:</td><td>45.0</td><td>45.0</td></tr> <tr><td>SEAT WIDTH:</td><td>19.5</td><td>19.5</td></tr> <tr><td>SEAT DEPTH:</td><td>17.0</td><td>17.0</td></tr> <tr><td>SEAT HEIGHT:</td><td>30.0</td><td>30.0</td></tr> <tr><td>BACK WIDTH:</td><td>20.0</td><td>20.0</td></tr> <tr><td>BACK HEIGHT:</td><td>16.0</td><td>16.0</td></tr> <tr><td>COM:</td><td>N/A</td><td>N/A</td></tr> <tr><td>WEIGHT:</td><td>23.5 LB</td><td>26.5 LB</td></tr> </tbody> </table>		ARMLESS	W/ ARMS	WIDTH:	21.5	25.5	DEPTH:	25.0	25.0	HEIGHT:	45.0	45.0	SEAT WIDTH:	19.5	19.5	SEAT DEPTH:	17.0	17.0	SEAT HEIGHT:	30.0	30.0	BACK WIDTH:	20.0	20.0	BACK HEIGHT:	16.0	16.0	COM:	N/A	N/A	WEIGHT:	23.5 LB	26.5 LB	<p>A18B A18G \$45</p> <p>Soft Touch Polyurethane Arms - Black or Gray Color</p>	<p>G8 \$20 G9 \$30 G10 \$30</p> <p>Self-Leveling Metal Glide 4 per set Not Available on ST30 Stool, 1215 and 1265 models</p> <p>Self-Leveling VCT Glide 4 per set Not Available on ST30 Stool, 1215 and 1265 models</p> <p>Self-Leveling Felt Glide 4 per set Not Available on ST30 Stool, 1215 and 1265 models</p>	<p>GC1 \$30 GC2 \$30</p> <p>Ganging Clip - 2 per set GC1 - Armless-to-Armless GC2 - Arm-to-Arm</p>
	ARMLESS	W/ ARMS																																									
WIDTH:	21.5	25.5																																									
DEPTH:	25.0	25.0																																									
HEIGHT:	45.0	45.0																																									
SEAT WIDTH:	19.5	19.5																																									
SEAT DEPTH:	17.0	17.0																																									
SEAT HEIGHT:	30.0	30.0																																									
BACK WIDTH:	20.0	20.0																																									
BACK HEIGHT:	16.0	16.0																																									
COM:	N/A	N/A																																									
WEIGHT:	23.5 LB	26.5 LB																																									

PLASTIC COLORS

BLACK SWAN P01	CLASSIC BURGUNDY P02	CORAL RED P03	SUNBONNET YELLOW P04
WHITE WHISPER P05	BOULDER GRAY P06	DOVER SKY P07	ESSEX BLUE P08
PALE WATER GREEN P09	CINNABAR ORANGE P10	FEDERAL BLUE P11	

*Standard twenty five (25) business days applies only to Metallic Brown, Gunmetal, Dover Gray and White frame color options.

shuttle

the ultimate utility chair

GSA SIN # 711-19

- Seat and back styles include: all plastic, upholstered seat w/ plastic back or fully upholstered seat and back
- Bariatric, stools and tablet models available
- 11 plastic colors, 6 frame finishes
- Wall saver design on model 1210 and 1260
- Warranted up to 300 lbs
- CAL TB 133 Fire Code approved
- Three Seat Height Choices



CREATING SHUTTLE MODEL NUMBER

MODEL NUMBER CONTROL ARMS FRAME COLOR UPHOLSTERY PLASTIC COLOR GRADE CASTERS PACKAGING

1 2 - S T - A - U S - P - - - - -

* FOR ARMLESS CODE USE A00 * ONLY SELECT CASTER CODE FOR MODEL 1215,1265

FRAME COLORS

BLACK BF	SILVER SF	METALLIC BROWN* MBF
GUNMETAL* GMF	DOVER GRAY* DGF	WHITE* WF

PACKAGING NOTES

CODE	DESCRIPTION	LIST UPCHARGE
AB	ASSEMBLED IN BAG FOR WILL CALL	\$0
AC	ASSEMBLED IN CARTON	\$0

SHUTTLE SIDE CHAIRS SHIP UP TO 3 PER CARTON

NEW ALL PLASTIC - AP

MODEL	CONTROL	DESCRIPTION	MESH	ARM	PLASTIC	FEATURES	DIMENSIONS	ARM OPTIONS	ADDITIONAL OPTIONS	ACCESSORIES																																	
1260	ST24	24" STOOL Mesh back and plastic seat. Use for work surfaces up to 34 inches high.	M1 M1 M2/M3 M2/M3 M2/M3	ARMLESS A18B A18G ARMLESS A18B A18G	P 440 485 485 470 515 515	<ul style="list-style-type: none"> • Non-Marring Floor Glides • Foot rest • Rated for 300 lbs 	<table border="1"> <thead> <tr> <th></th> <th>ARMLESS</th> <th>W/ ARMS</th> </tr> </thead> <tbody> <tr><td>WIDTH:</td><td>21.5</td><td>25.5</td></tr> <tr><td>DEPTH:</td><td>25.0</td><td>25.0</td></tr> <tr><td>HEIGHT:</td><td>39.0</td><td>39.0</td></tr> <tr><td>SEAT WIDTH:</td><td>19.5</td><td>19.5</td></tr> <tr><td>SEAT DEPTH:</td><td>17.0</td><td>17.0</td></tr> <tr><td>SEAT HEIGHT:</td><td>24.0</td><td>24.0</td></tr> <tr><td>BACK WIDTH:</td><td>20.0</td><td>20.0</td></tr> <tr><td>BACK HEIGHT:</td><td>16.0</td><td>16.0</td></tr> <tr><td>COM:</td><td>N/A</td><td>N/A</td></tr> <tr><td>WEIGHT:</td><td>21.5 LB</td><td>24.5 LB</td></tr> </tbody> </table>		ARMLESS	W/ ARMS	WIDTH:	21.5	25.5	DEPTH:	25.0	25.0	HEIGHT:	39.0	39.0	SEAT WIDTH:	19.5	19.5	SEAT DEPTH:	17.0	17.0	SEAT HEIGHT:	24.0	24.0	BACK WIDTH:	20.0	20.0	BACK HEIGHT:	16.0	16.0	COM:	N/A	N/A	WEIGHT:	21.5 LB	24.5 LB	<p>A18B A18G \$45</p> <p>Soft Touch Polyurethane Arms - Black or Gray Color</p>	<p>G8 \$20 G9 \$30 G10 \$30</p> <p>Self-Leveling Metal Glide 4 per set Not Available on ST30 Stool, 1215 and 1265 models</p> <p>Self-Leveling VCT Glide 4 per set Not Available on ST30 Stool, 1215 and 1265 models</p> <p>Self-Leveling Felt Glide 4 per set Not Available on ST30 Stool, 1215 and 1265 models</p>	<p>GC1 \$30 GC2 \$30</p> <p>Ganging Clip - 2 per set GC1 - Armless-to-Armless GC2 - Arm-to-Arm</p>
	ARMLESS	W/ ARMS																																									
WIDTH:	21.5	25.5																																									
DEPTH:	25.0	25.0																																									
HEIGHT:	39.0	39.0																																									
SEAT WIDTH:	19.5	19.5																																									
SEAT DEPTH:	17.0	17.0																																									
SEAT HEIGHT:	24.0	24.0																																									
BACK WIDTH:	20.0	20.0																																									
BACK HEIGHT:	16.0	16.0																																									
COM:	N/A	N/A																																									
WEIGHT:	21.5 LB	24.5 LB																																									
1260	ST27	27" STOOL Mesh back and plastic seat. Use for work surfaces up to 36 inches high.	M1 M1 M1 M2/M3 M2/M3 M2/M3	ARMLESS A18B A18G ARMLESS A18B A18G	P 440 485 485 470 515 515	<ul style="list-style-type: none"> • Non-Marring Floor Glides • Foot rest • Rated for 300 lbs 	<table border="1"> <thead> <tr> <th></th> <th>ARMLESS</th> <th>W/ ARMS</th> </tr> </thead> <tbody> <tr><td>WIDTH:</td><td>21.5</td><td>25.5</td></tr> <tr><td>DEPTH:</td><td>25.0</td><td>25.0</td></tr> <tr><td>HEIGHT:</td><td>42.0</td><td>42.0</td></tr> <tr><td>SEAT WIDTH:</td><td>19.5</td><td>19.5</td></tr> <tr><td>SEAT DEPTH:</td><td>17.0</td><td>17.0</td></tr> <tr><td>SEAT HEIGHT:</td><td>27.0</td><td>27.0</td></tr> <tr><td>BACK WIDTH:</td><td>20.0</td><td>20.0</td></tr> <tr><td>BACK HEIGHT:</td><td>16.0</td><td>16.0</td></tr> <tr><td>COM:</td><td>N/A</td><td>N/A</td></tr> <tr><td>WEIGHT:</td><td>22.5 LB</td><td>25.5 LB</td></tr> </tbody> </table>		ARMLESS	W/ ARMS	WIDTH:	21.5	25.5	DEPTH:	25.0	25.0	HEIGHT:	42.0	42.0	SEAT WIDTH:	19.5	19.5	SEAT DEPTH:	17.0	17.0	SEAT HEIGHT:	27.0	27.0	BACK WIDTH:	20.0	20.0	BACK HEIGHT:	16.0	16.0	COM:	N/A	N/A	WEIGHT:	22.5 LB	25.5 LB	<p>G8 \$20 G9 \$30 G10 \$30</p> <p>Self-Leveling Metal Glide 4 per set Not Available on ST30 Stool, 1215 and 1265 models</p> <p>Self-Leveling VCT Glide 4 per set Not Available on ST30 Stool, 1215 and 1265 models</p> <p>Self-Leveling Felt Glide 4 per set Not Available on ST30 Stool, 1215 and 1265 models</p>	<p>GC1 \$30 GC2 \$30</p> <p>Ganging Clip - 2 per set GC1 - Armless-to-Armless GC2 - Arm-to-Arm</p>	
	ARMLESS	W/ ARMS																																									
WIDTH:	21.5	25.5																																									
DEPTH:	25.0	25.0																																									
HEIGHT:	42.0	42.0																																									
SEAT WIDTH:	19.5	19.5																																									
SEAT DEPTH:	17.0	17.0																																									
SEAT HEIGHT:	27.0	27.0																																									
BACK WIDTH:	20.0	20.0																																									
BACK HEIGHT:	16.0	16.0																																									
COM:	N/A	N/A																																									
WEIGHT:	22.5 LB	25.5 LB																																									
1260	ST30	30" STOOL Mesh back and plastic seat. Use for work surfaces up to 42 inches high.	M1 M1 M1 M2/M3 M2/M3 M2/M3	ARMLESS A18B A18G ARMLESS A18B A18G	P 460 505 505 490 535 535	<ul style="list-style-type: none"> • Non-Marring Floor Glides • Foot rest • Rated for 300 lbs 	<table border="1"> <thead> <tr> <th></th> <th>ARMLESS</th> <th>W/ ARMS</th> </tr> </thead> <tbody> <tr><td>WIDTH:</td><td>21.5</td><td>25.5</td></tr> <tr><td>DEPTH:</td><td>25.0</td><td>25.0</td></tr> <tr><td>HEIGHT:</td><td>45.0</td><td>45.0</td></tr> <tr><td>SEAT WIDTH:</td><td>19.5</td><td>19.5</td></tr> <tr><td>SEAT DEPTH:</td><td>17.0</td><td>17.0</td></tr> <tr><td>SEAT HEIGHT:</td><td>30.0</td><td>30.0</td></tr> <tr><td>BACK WIDTH:</td><td>20.0</td><td>20.0</td></tr> <tr><td>BACK HEIGHT:</td><td>16.0</td><td>16.0</td></tr> <tr><td>COM:</td><td>N/A</td><td>N/A</td></tr> <tr><td>WEIGHT:</td><td>23.5 LB</td><td>26.5 LB</td></tr> </tbody> </table>		ARMLESS	W/ ARMS	WIDTH:	21.5	25.5	DEPTH:	25.0	25.0	HEIGHT:	45.0	45.0	SEAT WIDTH:	19.5	19.5	SEAT DEPTH:	17.0	17.0	SEAT HEIGHT:	30.0	30.0	BACK WIDTH:	20.0	20.0	BACK HEIGHT:	16.0	16.0	COM:	N/A	N/A	WEIGHT:	23.5 LB	26.5 LB	<p>G8 \$20 G9 \$30 G10 \$30</p> <p>Self-Leveling Metal Glide 4 per set Not Available on ST30 Stool, 1215 and 1265 models</p> <p>Self-Leveling VCT Glide 4 per set Not Available on ST30 Stool, 1215 and 1265 models</p> <p>Self-Leveling Felt Glide 4 per set Not Available on ST30 Stool, 1215 and 1265 models</p>	<p>GC1 \$30 GC2 \$30</p> <p>Ganging Clip - 2 per set GC1 - Armless-to-Armless GC2 - Arm-to-Arm</p>	
	ARMLESS	W/ ARMS																																									
WIDTH:	21.5	25.5																																									
DEPTH:	25.0	25.0																																									
HEIGHT:	45.0	45.0																																									
SEAT WIDTH:	19.5	19.5																																									
SEAT DEPTH:	17.0	17.0																																									
SEAT HEIGHT:	30.0	30.0																																									
BACK WIDTH:	20.0	20.0																																									
BACK HEIGHT:	16.0	16.0																																									
COM:	N/A	N/A																																									
WEIGHT:	23.5 LB	26.5 LB																																									

NOTE: ALL MESH STYLE AVAILABLE IN M1, M2 AND M3

NOTE: ALL MESH STYLE AVAILABLE IN M1, M2 AND M3

NOTE: ALL MESH STYLE AVAILABLE IN M1, M2 AND M3

*Standard twenty five (25) business days applies only to Metallic Brown, Gunmetal, Dover Gray and White frame color options.

shuttle

the ultimate utility chair

GSA SIN # 711-19

- Seat and back styles include: all plastic, upholstered seat w/ plastic back or fully upholstered seat and back
- Bariatric, stools and tablet models available
- 11 plastic colors, 6 frame finishes
- Wall saver design on model 1210 and 1260
- Warranted up to 300 lbs
- CAL TB 133 Fire Code approved



CREATING SHUTTLE MODEL NUMBER

MODEL NUMBER CONTROL ARMS FRAME COLOR UPHOLSTERY PLASTIC COLOR GRADE CASTERS PACKAGING

1 2 - S T - A - U S - P - - - -

* FOR ARMLESS CODE USE A00 * ONLY SELECT CASTER CODE FOR MODEL 1215,1265

FRAME COLORS

BLACK BF	SILVER SF	METALLIC BROWN* MBF
GUNMETAL* GMF	DOVER GRAY* DGF	WHITE* WF

PACKAGING NOTES

CODE	DESCRIPTION	LIST UPCHARGE
AB	ASSEMBLED IN BAG FOR WILL CALL	\$0
AC	ASSEMBLED IN CARTON	\$0

SHUTTLE SIDE CHAIRS SHIP UP TO 3 PER CARTON

NEW UPHOLSTERED SEAT - US

MODEL	CONTROL	DESCRIPTION	MESH	ARM	FABRIC	FEATURES	DIMENSIONS																																																		
1210	ST24	24" STOOL Plastic back with upholstered seat. Use for work surfaces up to 34 inches high.		ARMLESS A18B A18G	<table border="1"> <thead> <tr> <th>A/COM</th> <th>B</th> <th>C</th> <th>D</th> <th>E</th> <th>F</th> <th>G</th> </tr> </thead> <tbody> <tr> <td>440</td> <td>465</td> <td>485</td> <td>510</td> <td>540</td> <td>575</td> <td>610</td> </tr> <tr> <td>485</td> <td>510</td> <td>530</td> <td>555</td> <td>585</td> <td>620</td> <td>655</td> </tr> <tr> <td>485</td> <td>510</td> <td>530</td> <td>555</td> <td>585</td> <td>620</td> <td>655</td> </tr> </tbody> </table>	A/COM	B	C	D	E	F	G	440	465	485	510	540	575	610	485	510	530	555	585	620	655	485	510	530	555	585	620	655	<ul style="list-style-type: none"> • Non-Marring Floor Glides • Foot rest • Rated for 300 lbs 	<table border="1"> <thead> <tr> <th>ARMLESS</th> <th>W/ ARMS</th> </tr> </thead> <tbody> <tr> <td>WIDTH: 21.5</td> <td>25.5</td> </tr> <tr> <td>DEPTH: 25.0</td> <td>25.0</td> </tr> <tr> <td>HEIGHT: 39.0</td> <td>39.0</td> </tr> <tr> <td>SEAT WIDTH: 19.5</td> <td>19.5</td> </tr> <tr> <td>SEAT DEPTH: 17.0</td> <td>17.0</td> </tr> <tr> <td>SEAT HEIGHT: 24.0</td> <td>14.0</td> </tr> <tr> <td>BACK WIDTH: 20.0</td> <td>20.0</td> </tr> <tr> <td>BACK HEIGHT: 16.0</td> <td>16.0</td> </tr> <tr> <td>COM: 0.8 YDS</td> <td>0.8 YDS</td> </tr> <tr> <td>WEIGHT: 24.5 LB</td> <td>27.5 LB</td> </tr> </tbody> </table>	ARMLESS	W/ ARMS	WIDTH: 21.5	25.5	DEPTH: 25.0	25.0	HEIGHT: 39.0	39.0	SEAT WIDTH: 19.5	19.5	SEAT DEPTH: 17.0	17.0	SEAT HEIGHT: 24.0	14.0	BACK WIDTH: 20.0	20.0	BACK HEIGHT: 16.0	16.0	COM: 0.8 YDS	0.8 YDS	WEIGHT: 24.5 LB	27.5 LB
A/COM	B	C	D	E	F	G																																																			
440	465	485	510	540	575	610																																																			
485	510	530	555	585	620	655																																																			
485	510	530	555	585	620	655																																																			
ARMLESS	W/ ARMS																																																								
WIDTH: 21.5	25.5																																																								
DEPTH: 25.0	25.0																																																								
HEIGHT: 39.0	39.0																																																								
SEAT WIDTH: 19.5	19.5																																																								
SEAT DEPTH: 17.0	17.0																																																								
SEAT HEIGHT: 24.0	14.0																																																								
BACK WIDTH: 20.0	20.0																																																								
BACK HEIGHT: 16.0	16.0																																																								
COM: 0.8 YDS	0.8 YDS																																																								
WEIGHT: 24.5 LB	27.5 LB																																																								
1210	ST27	27" STOOL Plastic back with upholstered seat. Use for work surfaces up to 36 inches high.		ARMLESS A18B A18G	<table border="1"> <thead> <tr> <th>A/COM</th> <th>B</th> <th>C</th> <th>D</th> <th>E</th> <th>F</th> <th>G</th> </tr> </thead> <tbody> <tr> <td>440</td> <td>465</td> <td>485</td> <td>510</td> <td>540</td> <td>575</td> <td>610</td> </tr> <tr> <td>485</td> <td>510</td> <td>530</td> <td>555</td> <td>585</td> <td>620</td> <td>655</td> </tr> <tr> <td>485</td> <td>510</td> <td>530</td> <td>555</td> <td>585</td> <td>620</td> <td>655</td> </tr> </tbody> </table>	A/COM	B	C	D	E	F	G	440	465	485	510	540	575	610	485	510	530	555	585	620	655	485	510	530	555	585	620	655	<ul style="list-style-type: none"> • Non-Marring Floor Glides • Foot rest • Rated for 300 lbs 	<table border="1"> <tbody> <tr> <td>WIDTH: 21.5</td> <td>25.5</td> </tr> <tr> <td>DEPTH: 25.0</td> <td>25.0</td> </tr> <tr> <td>HEIGHT: 42.0</td> <td>42.0</td> </tr> <tr> <td>SEAT WIDTH: 19.5</td> <td>19.5</td> </tr> <tr> <td>SEAT DEPTH: 17.0</td> <td>17.0</td> </tr> <tr> <td>SEAT HEIGHT: 27.0</td> <td>17.0</td> </tr> <tr> <td>BACK WIDTH: 20.0</td> <td>20.0</td> </tr> <tr> <td>BACK HEIGHT: 16.0</td> <td>16.0</td> </tr> <tr> <td>COM: 0.8 YDS</td> <td>0.8 YDS</td> </tr> <tr> <td>WEIGHT: 25.0 LB</td> <td>28.0 LB</td> </tr> </tbody> </table>	WIDTH: 21.5	25.5	DEPTH: 25.0	25.0	HEIGHT: 42.0	42.0	SEAT WIDTH: 19.5	19.5	SEAT DEPTH: 17.0	17.0	SEAT HEIGHT: 27.0	17.0	BACK WIDTH: 20.0	20.0	BACK HEIGHT: 16.0	16.0	COM: 0.8 YDS	0.8 YDS	WEIGHT: 25.0 LB	28.0 LB		
A/COM	B	C	D	E	F	G																																																			
440	465	485	510	540	575	610																																																			
485	510	530	555	585	620	655																																																			
485	510	530	555	585	620	655																																																			
WIDTH: 21.5	25.5																																																								
DEPTH: 25.0	25.0																																																								
HEIGHT: 42.0	42.0																																																								
SEAT WIDTH: 19.5	19.5																																																								
SEAT DEPTH: 17.0	17.0																																																								
SEAT HEIGHT: 27.0	17.0																																																								
BACK WIDTH: 20.0	20.0																																																								
BACK HEIGHT: 16.0	16.0																																																								
COM: 0.8 YDS	0.8 YDS																																																								
WEIGHT: 25.0 LB	28.0 LB																																																								
1210	ST30	30" STOOL Plastic back with upholstered seat. Use for work surfaces up to 42 inches high.		ARMLESS A18B A18G	<table border="1"> <thead> <tr> <th>A/COM</th> <th>B</th> <th>C</th> <th>D</th> <th>E</th> <th>F</th> <th>G</th> </tr> </thead> <tbody> <tr> <td>460</td> <td>485</td> <td>505</td> <td>530</td> <td>560</td> <td>595</td> <td>630</td> </tr> <tr> <td>505</td> <td>530</td> <td>550</td> <td>575</td> <td>605</td> <td>640</td> <td>675</td> </tr> <tr> <td>505</td> <td>530</td> <td>550</td> <td>575</td> <td>605</td> <td>640</td> <td>675</td> </tr> </tbody> </table>	A/COM	B	C	D	E	F	G	460	485	505	530	560	595	630	505	530	550	575	605	640	675	505	530	550	575	605	640	675	<ul style="list-style-type: none"> • Non-Marring Floor Glides • Foot rest • Rated for 300 lbs 	<table border="1"> <tbody> <tr> <td>WIDTH: 21.5</td> <td>25.5</td> </tr> <tr> <td>DEPTH: 25.0</td> <td>25.0</td> </tr> <tr> <td>HEIGHT: 45.0</td> <td>45.0</td> </tr> <tr> <td>SEAT WIDTH: 19.5</td> <td>19.5</td> </tr> <tr> <td>SEAT DEPTH: 17.0</td> <td>17.0</td> </tr> <tr> <td>SEAT HEIGHT: 30.0</td> <td>30.0</td> </tr> <tr> <td>BACK WIDTH: 20.0</td> <td>20.0</td> </tr> <tr> <td>BACK HEIGHT: 16.0</td> <td>16.0</td> </tr> <tr> <td>COM: 0.8 YDS</td> <td>0.8 YDS</td> </tr> <tr> <td>WEIGHT: 25.5 LB</td> <td>28.5 LB</td> </tr> </tbody> </table>	WIDTH: 21.5	25.5	DEPTH: 25.0	25.0	HEIGHT: 45.0	45.0	SEAT WIDTH: 19.5	19.5	SEAT DEPTH: 17.0	17.0	SEAT HEIGHT: 30.0	30.0	BACK WIDTH: 20.0	20.0	BACK HEIGHT: 16.0	16.0	COM: 0.8 YDS	0.8 YDS	WEIGHT: 25.5 LB	28.5 LB		
A/COM	B	C	D	E	F	G																																																			
460	485	505	530	560	595	630																																																			
505	530	550	575	605	640	675																																																			
505	530	550	575	605	640	675																																																			
WIDTH: 21.5	25.5																																																								
DEPTH: 25.0	25.0																																																								
HEIGHT: 45.0	45.0																																																								
SEAT WIDTH: 19.5	19.5																																																								
SEAT DEPTH: 17.0	17.0																																																								
SEAT HEIGHT: 30.0	30.0																																																								
BACK WIDTH: 20.0	20.0																																																								
BACK HEIGHT: 16.0	16.0																																																								
COM: 0.8 YDS	0.8 YDS																																																								
WEIGHT: 25.5 LB	28.5 LB																																																								

NOTE: TLF AND TRF REQUIRE SOME ASSEMBLY

NOTE: TLF AND TRF REQUIRE SOME ASSEMBLY

NOTE: Due to the nature of vinyl upholstery, stacking may cause impressions on the seat. 9to5 Seating does not warrant the effects of the stacking on vinyl upholstery.

ARM OPTIONS

A18B
A18G
\$45

Soft Touch Polyurethane
Arms - Black or Gray Color

ADDITIONAL OPTIONS

G8 \$20
Self-Leveling Metal Glide
4 per set
Not Available on ST30 Stool, 1215 and 1265 models

G9 \$30
Self-Leveling VCT Glide
4 per set
Not Available on ST30 Stool, 1215 and 1265 models

G10 \$30
Self-Leveling Felt Glide
4 per set
Not Available on ST30 Stool, 1215 and 1265 models

EF1 \$30
MF1 \$50
EF1 - 1" Extra Foam on Seat
MF1 - 1" Visco Elastic Memory Foam on Seat

ACCESSORIES

GC1 \$30
GC2 \$30

Ganging Clip - 2 per set
GC1 - Armless-to-Armless
GC2 - Arm-to-Arm

PLASTIC COLORS

BLACK SWAN P01	CLASSIC BURGUNDY P02	CORAL RED P03	SUNBONNET YELLOW P04
WHITE WHISPER P05	BOULDER GRAY P06	DOVER SKY P07	ESSEX BLUE P08
PALE WATER GREEN P09	CINNABAR ORANGE P10	FEDERAL BLUE P11	

*Standard twenty five (25) business days applies only to Metallic Brown, Gunmetal, Dover Gray and White frame color options.

CAUTION: Careless stacking of chairs may scratch and damage frames. 9to5 Seating does not warrant scratched frames of stacking chairs.

shuttle

the ultimate utility chair

UPHOLSTERED SEAT - US

GSA SIN # 711-19

- Seat and back styles include: all plastic, upholstered seat w/ plastic back or fully upholstered seat and back
- Bariatric, stools and tablet models available
- 11 plastic colors, 6 frame finishes
- Wall saver design on model 1210 and 1260
- Warranted up to 300 lbs
- CAL TB 133 Fire Code approved



CREATING SHUTTLE MODEL NUMBER



MESH COLORS

BLACK - M11	GREEN - M14
GRAY - M12	RED - M15
SILVER - M13	BLUE - M16

FRAME COLORS

BLACK BF	SILVER SF	METALLIC BROWN* MBF
GUNMETAL* GMF	DOVER GRAY* DGF	WHITE* WF

PACKAGING NOTES

CODE	DESCRIPTION	LIST UPCHARGE
AB	ASSEMBLED IN BAG FOR WILL CALL	\$0
AC	ASSEMBLED IN CARTON	\$0

SHUTTLE SIDE CHAIRS SHIP UP TO 3 PER CARTON

NOTE: Due to the nature of vinyl upholstery, stacking may cause impressions on the seat. 9to5 Seating does not warrant the effects of the stacking on vinyl upholstery.

MODEL	CONTROL	DESCRIPTION	MESH	ARM	FABRIC	FEATURES							DIMENSIONS	
NEW MODEL 1260	ST24	24" STOOL Mesh back with upholstered seat. Use for work surfaces up to 34 inches high.	M1 M1 M1 M2/M3 M2/M3 M2/M3	ARMLESS A18B A18G ARMLESS A18B A18G	A/COM B C D E F G	<ul style="list-style-type: none"> • Non-Marring Floor Glides • Foot rest • Rated for 300 lbs 	ARMLESS WIDTH: 21.5 DEPTH: 25.0 HEIGHT: 39.0 SEAT WIDTH: 19.5 SEAT DEPTH: 17.0 SEAT HEIGHT: 27.0 BACK WIDTH: 20.0 BACK HEIGHT: 16.0 COM: 0.8 YDS WEIGHT: 24.5 LB	W/ ARMS 25.5 25.0 39.0 19.5 17.0 17.0 20.0 16.0 0.8 YDS 27.5 LB						

NOTE: ALL MESH STYLE AVAILABLE IN M1, M2 AND M3

1260	ST27	27" STOOL Mesh back with upholstered seat. Use for work surfaces up to 36 inches high.	M1 M1 M1 M2/M3 M2/M3 M2/M3	ARMLESS A18B A18G ARMLESS A18B A18G	A/COM B C D E F G	<ul style="list-style-type: none"> • Non-Marring Floor Glides • Foot rest • Rated for 300 lbs 	ARMLESS WIDTH: 21.5 DEPTH: 25.0 HEIGHT: 42.0 SEAT WIDTH: 19.5 SEAT DEPTH: 17.0 SEAT HEIGHT: 27.0 BACK WIDTH: 20.0 BACK HEIGHT: 16.0 COM: 0.8 YDS WEIGHT: 25.0 LB	W/ ARMS 25.5 25.0 42.0 19.5 17.0 17.0 20.0 16.0 0.8 YDS 28.0 LB
------	------	--	---	--	-------------------------------------	--	---	--

NOTE: ALL MESH STYLE AVAILABLE IN M1, M2 AND M3

1260	ST30	30" STOOL Mesh back with upholstered seat. Use for work surfaces up to 42 inches high.	M1 M1 M1 M2/M3 M2/M3 M2/M3	ARMLESS A18B A18G ARMLESS A18B A18G	A/COM B C D E F G	<ul style="list-style-type: none"> • Non-Marring Floor Glides • Foot rest • Rated for 300 lbs 	ARMLESS WIDTH: 21.5 DEPTH: 25.0 HEIGHT: 45.0 SEAT WIDTH: 19.5 SEAT DEPTH: 17.0 SEAT HEIGHT: 30.0 BACK WIDTH: 20.0 BACK HEIGHT: 16.0 COM: 0.8 YDS WEIGHT: 25.5 LB	W/ ARMS 25.5 25.0 45.0 19.5 17.0 30.0 20.0 16.0 0.8 YDS 28.5 LB
------	------	--	---	--	-------------------------------------	--	---	--

NOTE: ALL MESH STYLE AVAILABLE IN M1, M2 AND M3

ARM OPTIONS

A18B
A18G
\$45

Soft Touch Polyurethane Arms - Black or Gray Color

ADDITIONAL OPTIONS

G8 \$20
Self-Leveling Metal Glide
4 per set
Not Available on ST30 Stool, 1215 and 1265 models

G9 \$30
Self-Leveling VCT Glide
4 per set
Not Available on ST30 Stool, 1215 and 1265 models

G10 \$30
Self-Leveling Felt Glide
4 per set
Not Available on ST30 Stool, 1215 and 1265 models

EF1 \$30
EF1 - 1" Extra Foam on Seat

MF1 \$50
MF1 - 1" Visco Elastic Memory Foam on Seat

ACCESSORIES

GC1 \$30
GC2 \$30

Ganging Clip - 2 per set
GC1 - Armless-to-Armless
GC2 - Arm-to-Arm

PLASTIC COLORS

BLACK SWAN P01	CLASSIC BURGUNDY P02	CORAL RED P03	SUNBONNET YELLOW P04
WHITE WHISPER P05	BOULDER GRAY P06	DOVER SKY P07	ESSEX BLUE P08
PALE WATER GREEN P09	CINNABAR ORANGE P10	FEDERAL BLUE P11	

*Standard twenty five (25) business days applies only to Metallic Brown, Gunmetal, Dover Gray and White frame color options.

CAUTION: Careless stacking of chairs may scratch and damage frames. 9to5 Seating does not warrant scratched frames of stacking chairs.

shuttle

the ultimate utility chair

FULLY UPHOLSTERED - UP

GSA SIN # 711-19

- Seat and back styles include: all plastic, upholstered seat w/ plastic back or fully upholstered seat and back
- Bariatric, stools and tablet models available
- 11 plastic colors, 6 frame finishes
- Wall saver design on model 1210 and 1260
- Warranted up to 300 lbs
- CAL TB 133 Fire Code approved
- Three Seat Height Choices



CREATING SHUTTLE MODEL NUMBER

MODEL NUMBER CONTROL ARMS FRAME COLOR UPHOLSTERY GRADE CASTERS PACKAGING

1 2 3 0 - G T - A [] [] [] [] - U P - [] [] [] [] - [] [] [] []

FRAME COLORS

BLACK BF	SILVER SF	METALLIC BROWN* MBF
GUNMETAL* GMF	DOVER GRAY* DGF	WHITE* WF

PACKAGING NOTES

CODE	DESCRIPTION	LIST UPCHARGE
AB	ASSEMBLED IN BAG FOR WILL CALL	\$0
AC	ASSEMBLED IN CARTON	\$0

SHUTTLE SIDE CHAIRS SHIP UP TO 3 PER CARTON

NOTE: Due to the nature of vinyl upholstery, stacking may cause impressions on the seat. 9to5 Seating does not warrant the effects of the stacking on vinyl upholstery.

MODEL	CONTROL	DESCRIPTION	MESH	ARM	FABRIC	FEATURES	DIMENSIONS																																																		
NEW MODEL 1210	ST24	24" STOOL Fully upholstered back and seat. Use for work surfaces up to 34 inches high.		ARMLESS A18B A18G	<table border="1"> <thead> <tr> <th>A/COM</th> <th>B</th> <th>C</th> <th>D</th> <th>E</th> <th>F</th> <th>G</th> </tr> </thead> <tbody> <tr> <td>465</td> <td>505</td> <td>530</td> <td>570</td> <td>615</td> <td>665</td> <td>720</td> </tr> <tr> <td>510</td> <td>550</td> <td>575</td> <td>615</td> <td>660</td> <td>710</td> <td>765</td> </tr> <tr> <td>510</td> <td>550</td> <td>575</td> <td>615</td> <td>660</td> <td>710</td> <td>765</td> </tr> </tbody> </table>	A/COM	B	C	D	E	F	G	465	505	530	570	615	665	720	510	550	575	615	660	710	765	510	550	575	615	660	710	765	<ul style="list-style-type: none"> • Non-Marring Floor Glides • Foot rest • Rated from 300 lbs 	<table border="1"> <thead> <tr> <th>ARMLESS</th> <th>W/ ARMS</th> </tr> </thead> <tbody> <tr> <td>WIDTH: 21.5</td> <td>25.5</td> </tr> <tr> <td>DEPTH: 25.0</td> <td>25.0</td> </tr> <tr> <td>HEIGHT: 39.0</td> <td>39.0</td> </tr> <tr> <td>SEAT WIDTH: 19.5</td> <td>19.5</td> </tr> <tr> <td>SEAT DEPTH: 17.0</td> <td>17.0</td> </tr> <tr> <td>SEAT HEIGHT: 24.0</td> <td>24.0</td> </tr> <tr> <td>BACK WIDTH: 20.0</td> <td>20.0</td> </tr> <tr> <td>BACK HEIGHT: 16.0</td> <td>16.0</td> </tr> <tr> <td>COM: 1.2 YDS</td> <td>1.2 YDS</td> </tr> <tr> <td>WEIGHT: 26.0 LB</td> <td>29.0 LB</td> </tr> </tbody> </table>	ARMLESS	W/ ARMS	WIDTH: 21.5	25.5	DEPTH: 25.0	25.0	HEIGHT: 39.0	39.0	SEAT WIDTH: 19.5	19.5	SEAT DEPTH: 17.0	17.0	SEAT HEIGHT: 24.0	24.0	BACK WIDTH: 20.0	20.0	BACK HEIGHT: 16.0	16.0	COM: 1.2 YDS	1.2 YDS	WEIGHT: 26.0 LB	29.0 LB
A/COM	B	C	D	E	F	G																																																			
465	505	530	570	615	665	720																																																			
510	550	575	615	660	710	765																																																			
510	550	575	615	660	710	765																																																			
ARMLESS	W/ ARMS																																																								
WIDTH: 21.5	25.5																																																								
DEPTH: 25.0	25.0																																																								
HEIGHT: 39.0	39.0																																																								
SEAT WIDTH: 19.5	19.5																																																								
SEAT DEPTH: 17.0	17.0																																																								
SEAT HEIGHT: 24.0	24.0																																																								
BACK WIDTH: 20.0	20.0																																																								
BACK HEIGHT: 16.0	16.0																																																								
COM: 1.2 YDS	1.2 YDS																																																								
WEIGHT: 26.0 LB	29.0 LB																																																								
1210	ST27	27" STOOL Fully upholstered back and seat. Use for work surfaces up to 36 inches high.		ARMLESS A18B A18G	<table border="1"> <thead> <tr> <th>A/COM</th> <th>B</th> <th>C</th> <th>D</th> <th>E</th> <th>F</th> <th>G</th> </tr> </thead> <tbody> <tr> <td>465</td> <td>505</td> <td>530</td> <td>570</td> <td>615</td> <td>665</td> <td>720</td> </tr> <tr> <td>510</td> <td>550</td> <td>575</td> <td>615</td> <td>660</td> <td>710</td> <td>765</td> </tr> <tr> <td>510</td> <td>550</td> <td>575</td> <td>615</td> <td>660</td> <td>710</td> <td>765</td> </tr> </tbody> </table>	A/COM	B	C	D	E	F	G	465	505	530	570	615	665	720	510	550	575	615	660	710	765	510	550	575	615	660	710	765	<ul style="list-style-type: none"> • Non-Marring Floor Glides • Foot rest • Rated from 300 lbs 	<table border="1"> <tbody> <tr> <td>WIDTH: 21.5</td> <td>25.5</td> </tr> <tr> <td>DEPTH: 25.0</td> <td>25.0</td> </tr> <tr> <td>HEIGHT: 42.0</td> <td>42.0</td> </tr> <tr> <td>SEAT WIDTH: 19.5</td> <td>19.5</td> </tr> <tr> <td>SEAT DEPTH: 17.0</td> <td>17.0</td> </tr> <tr> <td>SEAT HEIGHT: 27.0</td> <td>27.0</td> </tr> <tr> <td>BACK WIDTH: 20.0</td> <td>20.0</td> </tr> <tr> <td>BACK HEIGHT: 16.0</td> <td>16.0</td> </tr> <tr> <td>COM: 1.2 YDS</td> <td>1.2 YDS</td> </tr> <tr> <td>WEIGHT: 26.0 LB</td> <td>29.0 LB</td> </tr> </tbody> </table>	WIDTH: 21.5	25.5	DEPTH: 25.0	25.0	HEIGHT: 42.0	42.0	SEAT WIDTH: 19.5	19.5	SEAT DEPTH: 17.0	17.0	SEAT HEIGHT: 27.0	27.0	BACK WIDTH: 20.0	20.0	BACK HEIGHT: 16.0	16.0	COM: 1.2 YDS	1.2 YDS	WEIGHT: 26.0 LB	29.0 LB		
A/COM	B	C	D	E	F	G																																																			
465	505	530	570	615	665	720																																																			
510	550	575	615	660	710	765																																																			
510	550	575	615	660	710	765																																																			
WIDTH: 21.5	25.5																																																								
DEPTH: 25.0	25.0																																																								
HEIGHT: 42.0	42.0																																																								
SEAT WIDTH: 19.5	19.5																																																								
SEAT DEPTH: 17.0	17.0																																																								
SEAT HEIGHT: 27.0	27.0																																																								
BACK WIDTH: 20.0	20.0																																																								
BACK HEIGHT: 16.0	16.0																																																								
COM: 1.2 YDS	1.2 YDS																																																								
WEIGHT: 26.0 LB	29.0 LB																																																								
1210	ST30	30" STOOL Fully upholstered back and seat. Use for work surfaces up to 42 inches high.		ARMLESS A18B A18G	<table border="1"> <thead> <tr> <th>A/COM</th> <th>B</th> <th>C</th> <th>D</th> <th>E</th> <th>F</th> <th>G</th> </tr> </thead> <tbody> <tr> <td>485</td> <td>525</td> <td>550</td> <td>590</td> <td>635</td> <td>685</td> <td>740</td> </tr> <tr> <td>530</td> <td>570</td> <td>595</td> <td>635</td> <td>680</td> <td>730</td> <td>785</td> </tr> <tr> <td>530</td> <td>570</td> <td>595</td> <td>635</td> <td>680</td> <td>730</td> <td>785</td> </tr> </tbody> </table>	A/COM	B	C	D	E	F	G	485	525	550	590	635	685	740	530	570	595	635	680	730	785	530	570	595	635	680	730	785	<ul style="list-style-type: none"> • Non-Marring Floor Glides • Foot rest • Rated from 300 lbs 	<table border="1"> <tbody> <tr> <td>WIDTH: 21.5</td> <td>25.5</td> </tr> <tr> <td>DEPTH: 25.0</td> <td>25.0</td> </tr> <tr> <td>HEIGHT: 45.0</td> <td>45.0</td> </tr> <tr> <td>SEAT WIDTH: 19.5</td> <td>19.5</td> </tr> <tr> <td>SEAT DEPTH: 17.0</td> <td>17.0</td> </tr> <tr> <td>SEAT HEIGHT: 30.0</td> <td>30.0</td> </tr> <tr> <td>BACK WIDTH: 20.0</td> <td>20.0</td> </tr> <tr> <td>BACK HEIGHT: 16.0</td> <td>16.0</td> </tr> <tr> <td>COM: 1.2 YDS</td> <td>1.2 YDS</td> </tr> <tr> <td>WEIGHT: 26.0 LB</td> <td>29.0 LB</td> </tr> </tbody> </table>	WIDTH: 21.5	25.5	DEPTH: 25.0	25.0	HEIGHT: 45.0	45.0	SEAT WIDTH: 19.5	19.5	SEAT DEPTH: 17.0	17.0	SEAT HEIGHT: 30.0	30.0	BACK WIDTH: 20.0	20.0	BACK HEIGHT: 16.0	16.0	COM: 1.2 YDS	1.2 YDS	WEIGHT: 26.0 LB	29.0 LB		
A/COM	B	C	D	E	F	G																																																			
485	525	550	590	635	685	740																																																			
530	570	595	635	680	730	785																																																			
530	570	595	635	680	730	785																																																			
WIDTH: 21.5	25.5																																																								
DEPTH: 25.0	25.0																																																								
HEIGHT: 45.0	45.0																																																								
SEAT WIDTH: 19.5	19.5																																																								
SEAT DEPTH: 17.0	17.0																																																								
SEAT HEIGHT: 30.0	30.0																																																								
BACK WIDTH: 20.0	20.0																																																								
BACK HEIGHT: 16.0	16.0																																																								
COM: 1.2 YDS	1.2 YDS																																																								
WEIGHT: 26.0 LB	29.0 LB																																																								

NOTE: ALL MESH STYLE AVAILABLE IN M1, M2 AND M3

NOTE: ALL MESH STYLE AVAILABLE IN M1, M2 AND M3

NOTE: ALL MESH STYLE AVAILABLE IN M1, M2 AND M3

ARM OPTIONS

A18B
A18G
\$45

Soft Touch Polyurethane
Arms - Black or Gray Color

ADDITIONAL OPTIONS

G8 \$20
Self-Leveling Metal Glide
4 per set
Not Available on ST30 Stool, 1215 and 1265 models

G9 \$30
Self-Leveling VCT Glide
4 per set
Not Available on ST30 Stool, 1215 and 1265 models

G10 \$30
Self-Leveling Felt Glide
4 per set
Not Available on ST30 Stool, 1215 and 1265 models

EF1 \$30
MF1 \$50
EF1 - 1" Extra Foam on Seat
MF1 - 1" Visco Elastic Memory Foam on Seat

BN1 \$35
BN2 \$0
Black Ballistic Nylon Back
BN1 w/ Grad A Fabrics
BN2 w/ Grade B and Up

ACCESSORIES

GC1 \$30
GC2 \$30

Ganging Clip - 2 per set
GC1 - Armless-to-Armless
GC2 - Arm-to-Arm

*Standard twenty five (25) business days applies only to Metallic Brown, Gunmetal, Dover Gray and White frame color options.

CAUTION: Careless stacking of chairs may scratch and damage frames. 9to5 Seating does not warrant scratched frames of stacking chairs.

shuttle

the ultimate utility chair

ALL PLASTIC - AP

GSA SIN # 711-19

- Seat and back styles include: all plastic, upholstered seat w/ plastic back or fully upholstered seat and back
- 11 plastic colors, 6 frame finishes
- Wall saver design on model 1210 and 1260
- Warranted up to 300 lbs
- CAL TB 133 Fire Code approved



CREATING SHUTTLE MODEL NUMBER

MODEL NUMBER CONTROL ARMS FRAME COLOR UPHOLSTERY MESH COLOR PLASTIC COLOR GRADE CASTERS PACKAGING

1 2 - G T - A - - - - - A P - M - - - - - P - - - - - P - - - - -

* FOR ARMLESS CODE USE A00 * ONLY SELECT CASTER CODE FOR MODEL 1215, 1265





FRAME COLORS

BLACK BF	SILVER SF	METALLIC BROWN* MBF
GUNMETAL* GMF	DOVER GRAY* DGF	WHITE* WF

PACKAGING NOTES

CODE	DESCRIPTION	LIST UPCHARGE
AB	ASSEMBLED IN BAG FOR WILL CALL	\$0
AC	ASSEMBLED IN CARTON	\$0

SHUTTLE SIDE CHAIRS SHIP UP TO 3 PER CARTON

MODEL	CONTROL	DESCRIPTION	MESH	ARM	PLASTIC	FEATURES	DIMENSIONS	ARM OPTIONS																				
1230	GT	GUEST Plastic back with plastic seat.		ARMLESS A18B A18G	P 345 390 390	<ul style="list-style-type: none"> • Non-Marring Floor Glides • Wall Saver Back Legs • Rated for 300 lbs 	<table border="1"> <tr> <th>ARMLESS</th> <th>W/ ARMS</th> </tr> <tr> <td>WIDTH: 21.5</td> <td>25.5</td> </tr> <tr> <td>DEPTH: 25.0</td> <td>25.0</td> </tr> <tr> <td>HEIGHT: 33.0</td> <td>33.0</td> </tr> <tr> <td>SEAT WIDTH: 19.5</td> <td>19.5</td> </tr> <tr> <td>SEAT DEPTH: 17.0</td> <td>17.0</td> </tr> <tr> <td>SEAT HEIGHT: 17.0</td> <td>17.0</td> </tr> <tr> <td>BACK WIDTH: 20.0</td> <td>20.0</td> </tr> <tr> <td>BACK HEIGHT: 16.0</td> <td>16.0</td> </tr> <tr> <td>WEIGHT: 21.0 LB</td> <td>24.0 LB</td> </tr> </table>	ARMLESS	W/ ARMS	WIDTH: 21.5	25.5	DEPTH: 25.0	25.0	HEIGHT: 33.0	33.0	SEAT WIDTH: 19.5	19.5	SEAT DEPTH: 17.0	17.0	SEAT HEIGHT: 17.0	17.0	BACK WIDTH: 20.0	20.0	BACK HEIGHT: 16.0	16.0	WEIGHT: 21.0 LB	24.0 LB	<div style="display: flex; justify-content: space-around;"> <div style="text-align: center;">  <p>A18B A18G \$45</p> <p>Soft Touch Polyurethane Arms - Black or Gray Color</p> </div> <div style="text-align: center;">  <p>TRF \$150</p> <p>Right Folding Tablet Arm in Black Laminate. Available with Black Frame only *Not Stackable with Tablet</p> </div> </div> <div style="text-align: center; margin-top: 20px;">  <p>TLF \$150</p> <p>Left Folding Tablet Arm in Black Laminate. Available with Black Frame only *Not Stackable with Tablet</p> </div>
ARMLESS	W/ ARMS																											
WIDTH: 21.5	25.5																											
DEPTH: 25.0	25.0																											
HEIGHT: 33.0	33.0																											
SEAT WIDTH: 19.5	19.5																											
SEAT DEPTH: 17.0	17.0																											
SEAT HEIGHT: 17.0	17.0																											
BACK WIDTH: 20.0	20.0																											
BACK HEIGHT: 16.0	16.0																											
WEIGHT: 21.0 LB	24.0 LB																											
1280	GT	GUEST Mesh back with plastic seat.	M1 M1 M1 M2/M3 M2/M3 M2/M3	ARMLESS A18B A18G ARMLESS A18B A18G	P 410 435 435 440 465 465	<ul style="list-style-type: none"> • Non-Marring Floor Glides • Wall Saver Back Legs • Rated for 300 lbs 	<table border="1"> <tr> <th>ARMLESS</th> <th>W/ ARMS</th> </tr> <tr> <td>WIDTH: 21.5</td> <td>25.5</td> </tr> <tr> <td>DEPTH: 25.0</td> <td>25.0</td> </tr> <tr> <td>HEIGHT: 33.0</td> <td>33.0</td> </tr> <tr> <td>SEAT WIDTH: 19.5</td> <td>19.5</td> </tr> <tr> <td>SEAT DEPTH: 17.0</td> <td>17.0</td> </tr> <tr> <td>SEAT HEIGHT: 17.0</td> <td>17.0</td> </tr> <tr> <td>BACK WIDTH: 20.0</td> <td>20.0</td> </tr> <tr> <td>BACK HEIGHT: 16.0</td> <td>16.0</td> </tr> <tr> <td>WEIGHT: 23.0 LB</td> <td>26.0 LB</td> </tr> </table>	ARMLESS	W/ ARMS	WIDTH: 21.5	25.5	DEPTH: 25.0	25.0	HEIGHT: 33.0	33.0	SEAT WIDTH: 19.5	19.5	SEAT DEPTH: 17.0	17.0	SEAT HEIGHT: 17.0	17.0	BACK WIDTH: 20.0	20.0	BACK HEIGHT: 16.0	16.0	WEIGHT: 23.0 LB	26.0 LB	<div style="text-align: center;">  <p>GC1 GC2 \$30</p> <p>Ganging Clip - 2 per set GC1 - Armless-to-Armless GC2 - Arm-to-Arm</p> </div>
ARMLESS	W/ ARMS																											
WIDTH: 21.5	25.5																											
DEPTH: 25.0	25.0																											
HEIGHT: 33.0	33.0																											
SEAT WIDTH: 19.5	19.5																											
SEAT DEPTH: 17.0	17.0																											
SEAT HEIGHT: 17.0	17.0																											
BACK WIDTH: 20.0	20.0																											
BACK HEIGHT: 16.0	16.0																											
WEIGHT: 23.0 LB	26.0 LB																											

NOTE: ALL MESH STYLE AVAILABLE IN M1, M2 AND M3

PLASTIC COLORS

BLACK SWAN P01	CLASSIC BURGUNDY P02	CORAL RED P03	SUNBONNET YELLOW P04
WHITE WHISPER P05	BOULDER GRAY P06	DOVER SKY P07	ESSEX BLUE P08
PALE WATER GREEN P09	CINNABAR ORANGE P10	FEDERAL BLUE P11	

*Standard twenty five (25) business days applies only to Metallic Brown, Gunmetal, Dover Gray and White frame color options.

CAUTION: Careless stacking of chairs may scratch and damage frames. 9to5 Seating does not warrant scratched frames of stacking chairs.

shuttle

the ultimate utility chair

UPHOLSTERED SEAT - US

GSA SIN # 711-19

- Seat and back styles include: all plastic, upholstered seat w/ plastic back or fully upholstered seat and back
- 11 plastic colors, 6 frame finishes
- Wall saver design on model 1210 and 1260
- Warranted up to 300 lbs
- CAL TB 133 Fire Code approved



CREATING SHUTTLE MODEL NUMBER

MODEL NUMBER CONTROL ARMS FRAME COLOR UPHOLSTERY MESH COLOR PLASTIC COLOR GRADE CASTERS PACKAGING

1 2 - G T - A - U S - M - P - - - -

* FOR ARMLESS CODE USE A00 * ONLY SELECT CASTER CODE FOR MODEL 1215,1265

MESH COLORS

BLACK - M11	GREEN - M14
GRAY - M12	RED - M15
SILVER - M13	BLUE - M16

FRAME COLORS

BLACK BF	SILVER SF	METALLIC BROWN* MBF
GUNMETAL* GMF	DOVER GRAY* DGF	WHITE* WF

PACKAGING NOTES

CODE	DESCRIPTION	LIST UPCHARGE
AB	ASSEMBLED IN BAG FOR WILL CALL	\$0
AC	ASSEMBLED IN CARTON	\$0

SHUTTLE SIDE CHAIRS SHIP UP TO 3 PER CARTON

NOTE: Due to the nature of vinyl upholstery, stacking may cause impressions on the seat. 9to5 Seating does not warrant the effects of the stacking on vinyl upholstery.

MODEL	CONTROL	DESCRIPTION	MESH	ARM	FABRIC	FEATURES	DIMENSIONS	ARM OPTIONS	ADDITIONAL OPTIONS
1230	GT	GUEST Plastic back with upholstered seat.		A00	A/COM 410, B 435, C 455, D 480, E 510, F 545, G 580	<ul style="list-style-type: none"> • Non-Marring Floor Glides • Wall Saver Back Legs • Rated for 300 lbs 	ARMLESS WIDTH: 21.5, DEPTH: 25.0, HEIGHT: 33.0 W/ ARMS WIDTH: 25.5, DEPTH: 25.0, HEIGHT: 33.0 SEAT WIDTH: 19.5, SEAT DEPTH: 17.0, SEAT HEIGHT: 17.0 BACK WIDTH: 20.0, BACK HEIGHT: 16.0 COM: 0.8 YDS, WEIGHT: 21.0 LB	A18B \$45 A18G \$45 Soft Touch Polyurethane Arms - Black or Gray Color TRF \$150 Right Folding Tablet Arm in Black Laminate. Available with Black Frame only *Not Stackable with Tablet	TLF \$150 Left Folding Tablet Arm in Black Laminate. Available with Black Frame only *Not Stackable with Tablet
	A18B		455, 480, 500, 525, 555, 590, 625						
	A18G		455, 480, 500, 525, 555, 590, 625						
	TLF		560, 585, 605, 630, 660, 695, 730						
	TRF		560, 585, 605, 630, 660, 695, 730						
NOTE: ALL MESH STYLE AVAILABLE IN M1, M2 AND M3									
1280	GT	GUEST Mesh back with upholstered seat.	M1	ARMLESS	475, 500, 520, 545, 575, 610, 645	<ul style="list-style-type: none"> • Non-Marring Floor Glides • Wall Saver Back Legs • Rated for 300 lbs 	ARMLESS WIDTH: 21.5, DEPTH: 25.0, HEIGHT: 33.0 W/ ARMS WIDTH: 25.5, DEPTH: 25.0, HEIGHT: 33.0 SEAT WIDTH: 19.5, SEAT DEPTH: 17.0, SEAT HEIGHT: 17.0 BACK WIDTH: 20.0, BACK HEIGHT: 16.0 COM: 0.8 YDS, WEIGHT: 23.0 LB	EF1 \$30 MF1 \$50 EF1 - 1" Extra Foam on Seat MF1 - 1" Visco Elastic Memory Foam on Seat	GC1 \$30 GC2 \$30 Ganging Clip - 2 per set GC1 - Armless-to-Armless GC2 - Arm-to-Arm
	M1		A18B	520, 545, 565, 590, 620, 655, 690					
	M1		A18G	520, 545, 565, 590, 620, 655, 690					
	M2/M3		ARMLESS	505, 530, 550, 575, 605, 640, 675					
	M2/M3		A18B	550, 575, 595, 620, 650, 685, 720					
	M2/M3	A18G	550, 575, 595, 620, 650, 685, 720						
NOTE: ALL MESH STYLE AVAILABLE IN M1, M2 AND M3									

*Standard twenty five (25) business days applies only to Metallic Brown, Gunmetal, Dover Gray and White frame color options.

CAUTION: Careless stacking of chairs may scratch and damage frames. 9to5 Seating does not warrant scratched frames of stacking chairs.

PLASTIC COLORS

BLACK SWAN P01	CLASSIC BURGUNDY P02	CORAL RED P03	SUNBONNET YELLOW P04
WHITE WHISPER P05	BOULDER GRAY P06	DOVER SKY P07	ESSEX BLUE P08
PALE WATER GREEN P09	CINNABAR ORANGE P10	FEDERAL BLUE P11	

shuttle

the ultimate utility chair

FULLY UPHOLSTERED - UP

GSA SIN # 711-19

- Seat and back styles include: all plastic, upholstered seat w/ plastic back or fully upholstered seat and back
- Bariatric, stools and tablet models available
- 6 powder coated frame finishes
- Wall saver design on model 1210 and 1260
- Warranted up to 300 lbs
- CAL TB 133 Fire Code approved



CREATING SHUTTLE MODEL NUMBER

MODEL NUMBER CONTROL ARMS FRAME COLOR UPHOLSTERY GRADE CASTERS PACKAGING
1 2 3 0 - G T - A - - **U P** - -

FRAME COLORS

BLACK BF	SILVER SF	METALLIC BROWN* MBF
GUNMETAL* GMF	DOVER GRAY* DGF	WHITE* WF

PACKAGING NOTES

CODE	DESCRIPTION	LIST UPCHARGE
AB	ASSEMBLED IN BAG FOR WILL CALL	\$0
AC	ASSEMBLED IN CARTON	\$0

SHUTTLE SIDE CHAIRS SHIP UP TO 3 PER CARTON

NOTE: Due to the nature of vinyl upholstery, stacking may cause impressions on the seat. 9to5 Seating does not warrant the effects of the stacking on vinyl upholstery.

MODEL	CONTROL	DESCRIPTION	MESH	ARM	FABRIC							FEATURES	DIMENSIONS																							
					A/COM	B	C	D	E	F	G																									
1230	GT	GUEST Fully upholstered back and seat.		A00	435	475	500	540	585	635	690		<ul style="list-style-type: none"> • Non-Marring Floor Glides • Wall Saver Back Legs • Rated for 300 lbs 	<table border="1"> <thead> <tr> <th>ARMLESS</th> <th>W/ ARMS</th> </tr> </thead> <tbody> <tr> <td>WIDTH: 36.5</td> <td>36.5</td> </tr> <tr> <td>DEPTH: 25.0</td> <td>25.0</td> </tr> <tr> <td>HEIGHT: 33.0</td> <td>33.0</td> </tr> <tr> <td>SEAT WIDTH: 31.0</td> <td>31.0</td> </tr> <tr> <td>SEAT DEPTH: 17.0</td> <td>17.0</td> </tr> <tr> <td>SEAT HEIGHT: 19.0</td> <td>19.0</td> </tr> <tr> <td>BACK WIDTH: 30.0</td> <td>30.0</td> </tr> <tr> <td>BACK HEIGHT: 16.0</td> <td>16.0</td> </tr> <tr> <td>COM: 1.2 YDS</td> <td>1.2 YDS</td> </tr> <tr> <td>WEIGHT: 24.0 LB</td> <td>27.0 LB</td> </tr> </tbody> </table>	ARMLESS	W/ ARMS	WIDTH: 36.5	36.5	DEPTH: 25.0	25.0	HEIGHT: 33.0	33.0	SEAT WIDTH: 31.0	31.0	SEAT DEPTH: 17.0	17.0	SEAT HEIGHT: 19.0	19.0	BACK WIDTH: 30.0	30.0	BACK HEIGHT: 16.0	16.0	COM: 1.2 YDS	1.2 YDS	WEIGHT: 24.0 LB	27.0 LB
ARMLESS	W/ ARMS																																			
WIDTH: 36.5	36.5																																			
DEPTH: 25.0	25.0																																			
HEIGHT: 33.0	33.0																																			
SEAT WIDTH: 31.0	31.0																																			
SEAT DEPTH: 17.0	17.0																																			
SEAT HEIGHT: 19.0	19.0																																			
BACK WIDTH: 30.0	30.0																																			
BACK HEIGHT: 16.0	16.0																																			
COM: 1.2 YDS	1.2 YDS																																			
WEIGHT: 24.0 LB	27.0 LB																																			
		A18B	480	520	545	585	630	680	735																											
		A18G	480	520	545	585	630	680	735																											
		TLF	585	625	650	690	735	785	840																											
		TRF	585	625	650	690	735	785	840																											

ARM OPTIONS

A18B
\$45

Soft Touch Polyurethane Arms - Black Color

TRF
\$150

Right Folding Tablet Arm in Black Laminate. Available with Black Frame only
*Not Stackable with Tablet

A18G
\$45

Soft Touch Polyurethane Arms - Gray Color

TLF
\$150

Left Folding Tablet Arm in Black Laminate. Available with Black Frame only
*Not Stackable with Tablet

ADDITIONAL OPTIONS

BN1 \$35
BN2 \$0

Black Ballistic Nylon Back
BN1 w/ Grad A Fabrics
BN2 w/ Grade B and Up

EF1 \$30
MF1 \$50

EF1 - 1" Extra Foam on Seat
MF1 - 1" Visco Elastic Memory Foam on Seat

*Standard twenty five (25) business days applies only to Metallic Brown, Gunmetal, Dover Gray and White frame color options.

shuttle

the ultimate utility chair

GSA SIN # 711-19

- Wall saver legs on model 1210
- 6 powder coated frame finishes
- Bariatric Warranted up to 600 lbs
- CAL TB 133 Fire Code approved



BARIATRIC - 30" SEAT RATED FOR 600 LB

CREATING SHUTTLE MODEL NUMBER

MODEL NUMBER CONTROL ARMS FRAME COLOR UPHOLSTERY GRADE PACKAGING
1 2 5 0 - G T - A 1 8 - - - - **U P** - - - -

FRAME COLORS









BLACK BF	SILVER SF	METALLIC BROWN* MBF
GUNMETAL* GMF	DOVER GRAY* DGF	WHITE* WF

PACKAGING NOTES

CODE	DESCRIPTION	LIST UPCHARGE
AB	ASSEMBLED IN BAG FOR WILL CALL	\$0
AC	ASSEMBLED IN CARTON	\$0

SHUTTLE SIDE CHAIRS SHIP UP TO 3 PER CARTON

NOTE: Due to the nature of vinyl upholstery, stacking may cause impressions on the seat. 9to5 Seating does not warrant the effects of the stacking on vinyl upholstery.

MODEL	CONTROL	DESCRIPTION	MESH	ARM	FABRIC							FEATURES	DIMENSIONS	ARM OPTIONS	ACCESSORIES	
					A/COM	B	C	D	E	F	G					
1250	GT	GUEST BARIATRIC Fully upholstered back and seat. Chair comes standard with arms.		A18B A18G	800	870	915	985	1065	1155	1255	<ul style="list-style-type: none"> • Steel Reinforced Seat and Back • 30" Wide Seat • Does Not Stack • Rated for 300 lbs 	WIDTH: 36.5 DEPTH: 25.0 HEIGHT: 33.0 SEAT WIDTH: 31.0 SEAT DEPTH: 17.0 SEAT HEIGHT: 19.0 BACK WIDTH: 30.0 BACK HEIGHT: 16.0 COM: 2.2 YDS WEIGHT: 32.0 LB	 A18B STD Soft Touch Polyurethane Arms - Black Color	 GC2 \$30 Ganging Clip - 2 per set GC2 - Arm-to-Arm	
														 A18G STD Soft Touch Polyurethane Arms - Gray Color		
														 G8 \$20 Self-Leveling Metal Glide Model 1250 Only 4 per set	 G9 \$30 Self-Leveling VCT Glide Model 1250 Only 4 per set	 G10 \$30 Self-Leveling Felt Glide Model 1250 Only 4 per set
														 BN1 \$35 Black Ballistic Nylon Back BN1 w/ Grad A Fabrics BN2 w/ Grade B and Up	 BN2 \$0	

*Standard twenty five (25) business days applies only to Metallic Brown, Gunmetal, Dover Gray and White frame color options.

sophie

ultimate comfort in a complete line of area seating

GSA SIN # 711-16

- Thick molded foam seat and back
- Robust design for the most rigorous public areas
- Removable seat and back cover
- Gray or black arm caps
- 6 powder coat frame colors
- Non-marring adjustable feet



CREATING SOPHIE MODEL NUMBER

MODEL NUMBER CONTROL ARMS FRAME COLOR GRADE PACKAGING OPTIONS
8 1 1 - **GT** - **A 8 0** - - - - **A C** - - - -

* CHROME FRAME COLOR (CF) IS NO LONGER AVAILABLE AND HAS BEEN REPLACED WITH POLISHED ALUMINUM (PF)

FRAME COLORS

BLACK BF	SILVER SF	METALLIC BROWN MBF
GUNMETAL GMF	DOVER GRAY DGF	WHITE WF

NEW SOFT SEATING LOUNGE

MODEL	CONTROL	DESCRIPTION	ARM	FABRIC	DIMENSIONS								FEATURES	
NEW MODEL														
8111	GT	SINGLE SEAT Lounge seat with armrest	SWA		A/COM	B	C	D	E	F	G			<ul style="list-style-type: none"> • Molded Foam Inner Seat and Back • Black or Gray Padded Arms • Clear Access Legs • Non-marring Adjustable Feet • Rated for 350 lbs
					695	745	775	825	880	940	1005			
NEW MODEL														
8112	GT	DOUBLE SEAT Lounge seat with outside armrest	SWA		A/COM	B	C	D	E	F	G			<ul style="list-style-type: none"> • Molded Foam Inner Seat and Back • Black or Gray Padded Arms • Clear Access Legs • Non-marring Adjustable Feet • Rated for 700 lbs
					1095	1195	1255	1355	1465	1585	1715			
NEW MODEL														
8113	GT	TRIPLE SEAT Lounge seat with outside armrest	SWA		A/COM	B	C	D	E	F	G			<ul style="list-style-type: none"> • Molded Foam Inner Seat and Back • Black or Gray Padded Arms • Clear Access Legs • Non-marring Adjustable feet • Rated for 1000 lbs
					1595	1745	1835	1985	2150	2330	2525			

ARM OPTIONS



WIDTH: 25.0
DEPTH: 27.25
HEIGHT: 33.75
SEAT WIDTH: 20.0
SEAT DEPTH: 19.0
SEAT HEIGHT: 18
BACK WIDTH: 20.5
BACK HEIGHT: 16
COM: 1.5 YD
WEIGHT: 56 LB

WIDTH: 45.75
DEPTH: 27.25
HEIGHT: 33.75
SEAT WIDTH: 20.5
SEAT DEPTH: 19
SEAT HEIGHT: 18
BACK WIDTH: 20
BACK HEIGHT: 16
COM: 3.0 YD
WEIGHT: 87 LB

WIDTH: 66.5
DEPTH: 27.25
HEIGHT: 33.75
SEAT WIDTH: 20.5
SEAT DEPTH: 19
SEAT HEIGHT: 18
BACK WIDTH: 20.5
BACK HEIGHT: 16
COM: 4.5 YD
WEIGHT: 118 LB

AVAILABLE FEBRUARY 2017

Standard 25 Day Lead Time: twenty five (25) business days applies to all Sophie models regardless of quantity. \$100 NET per shipment for Sophie orders of 3 chair model units or less.

sophie

ultimate comfort in a complete line of area seating

GSA SIN # 711-16

- Thick molded foam
- Robust design for the most rigorous public areas
- Removable seat and back cover
- Gray or black arm caps
- 6 powder coat frame colors
- Non-marring adjustable feet



CREATING SOPHIE MODEL NUMBER

MODEL NUMBER CONTROL ARMS FRAME COLOR GRADE PACKAGING OPTIONS
8 1 2 - **GT** - **A 8 0** - - - - **AC** - - - -

* CHROME FRAME COLOR (CF) IS NO LONGER AVAILABLE AND HAS BEEN REPLACED WITH POLISHED ALUMINUM (PF)

FRAME COLORS

BLACK BF	SILVER SF	METALLIC BROWN MBF
GUNMETAL GMF	DOVER GRAY DGF	WHITE WF

NEW SOFT SEATING LOUNGE

MODEL	CONTROL	DESCRIPTION	ARM	FABRIC	FEATURES	DIMENSIONS														
NEW MODEL 8122	GT	DOUBLE SEAT Lounge chair with center armrest	SWA	<table border="1"> <thead> <tr> <th>A/COM</th> <th>B</th> <th>C</th> <th>D</th> <th>E</th> <th>F</th> <th>G</th> </tr> </thead> <tbody> <tr> <td>1195</td> <td>1295</td> <td>1355</td> <td>1455</td> <td>1565</td> <td>1685</td> <td>1815</td> </tr> </tbody> </table>	A/COM	B	C	D	E	F	G	1195	1295	1355	1455	1565	1685	1815	<ul style="list-style-type: none"> • Molded Foam Seat and Back • Black and Gray Padded Arms • Clear Access Legs • Non-marring Adjustable Feet • Rated for 500 lbs 	WIDTH: 47.5 DEPTH: 27.25 HEIGHT: 33.75 SEAT WIDTH: 20.5 SEAT DEPTH: 19 SEAT HEIGHT: 18 BACK WIDTH: 20 BACK HEIGHT: 16 COM: 3.0 YD WEIGHT: 95 LB
A/COM	B	C	D	E	F	G														
1195	1295	1355	1455	1565	1685	1815														
NEW MODEL 8123	GT	TRIPLE SEAT Lounge chair with center armrest	SWA	<table border="1"> <thead> <tr> <th>A/COM</th> <th>B</th> <th>C</th> <th>D</th> <th>E</th> <th>F</th> <th>G</th> </tr> </thead> <tbody> <tr> <td>1795</td> <td>1945</td> <td>2035</td> <td>2185</td> <td>2350</td> <td>2530</td> <td>2725</td> </tr> </tbody> </table>	A/COM	B	C	D	E	F	G	1795	1945	2035	2185	2350	2530	2725	<ul style="list-style-type: none"> • Molded Foam Seat and Back • Black and Gray Padded Arms • Clear Access Legs • Non-marring Adjustable Feet • Rated for 750 lbs 	WIDTH: 70 DEPTH: 27.25 HEIGHT: 33.75 SEAT WIDTH: 20.5 SEAT DEPTH: 19 SEAT HEIGHT: 18 BACK WIDTH: 20.0 BACK HEIGHT: 16.0 COM: 4.5 YD WEIGHT: 136 LB
A/COM	B	C	D	E	F	G														
1795	1945	2035	2185	2350	2530	2725														

ARM OPTIONS

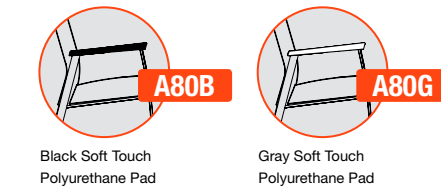

AVAILABLE MARCH 2017

Standard 25 Day Lead Time: twenty five (25) business days applies to all Sophie models regardless of quantity. \$100 NET per shipment for Sophie orders of 3 chair model units or less.

sophie

ultimate comfort in a complete line of area seating

GSA SIN # 711-16

- Thick foam
- Robust design for the most rigorous public areas
- Removable seat and back cover
- 6 powder coat frame colors
- Non-marring adjustable feet



CREATING SOPHIE MODEL NUMBER

MODEL NUMBER CONTROL ARMS FRAME COLOR GRADE PACKAGING OPTIONS

8 1 0 - G T - 0 0 0 0 - - - A C - - -

* CHROME FRAME COLOR (CFL) IS NO LONGER AVAILABLE AND HAS BEEN REPLACED WITH POLISHED ALUMINUM (PF)

FRAME COLORS

BLACK BF	SILVER SF	METALLIC BROWN MBF
GUNMETAL GMF	DOVER GRAY DMF	WHITE WF

NEW SOFT SEATING BENCHES

MODEL	CONTROL	DESCRIPTION	ARM	FABRIC	FEATURES	DIMENSIONS														
NEW MODEL 8102	GT	DOUBLE SEAT BENCH Bench seating for two	SWA	<table border="1"> <thead> <tr> <th>A/COM</th> <th>B</th> <th>C</th> <th>D</th> <th>E</th> <th>F</th> <th>G</th> </tr> </thead> <tbody> <tr> <td>665</td> <td>730</td> <td>770</td> <td>835</td> <td>910</td> <td>990</td> <td>1080</td> </tr> </tbody> </table>	A/COM	B	C	D	E	F	G	665	730	770	835	910	990	1080	<ul style="list-style-type: none"> • Molded Foam Seat and Back • Black and Gray Padded Arms • Clear Access Legs • Non-marring Adjustable Feet • Rated for 500 lbs 	<p>WIDTH: 44.75</p> <p>DEPTH: 23.5</p> <p>HEIGHT: 18</p> <p>SEAT WIDTH: 20.5</p> <p>SEAT DEPTH: 23.5</p> <p>SEAT HEIGHT: 18</p> <p>BACK WIDTH: 20</p> <p>BACK HEIGHT: 16</p> <p>COM: 2 YRD</p> <p>WEIGHT: 44 LB</p>
A/COM	B	C	D	E	F	G														
665	730	770	835	910	990	1080														
NEW MODEL 8103	GT	TRIPLE SEAT BENCH Bench seating for three	SWA	<table border="1"> <thead> <tr> <th>A/COM</th> <th>B</th> <th>C</th> <th>D</th> <th>E</th> <th>F</th> <th>G</th> </tr> </thead> <tbody> <tr> <td>1165</td> <td>1265</td> <td>1325</td> <td>1425</td> <td>1535</td> <td>1655</td> <td>1785</td> </tr> </tbody> </table>	A/COM	B	C	D	E	F	G	1165	1265	1325	1425	1535	1655	1785	<ul style="list-style-type: none"> • Molded Foam Seat and Back • Black and Gray Padded Arms • Clear Access Legs • Non-marring Adjustable Feet • Rated for 750 lbs 	<p>WIDTH: 65.5</p> <p>DEPTH: 23.5</p> <p>HEIGHT: 18</p> <p>SEAT WIDTH: 20.5</p> <p>SEAT DEPTH: 23.5</p> <p>SEAT HEIGHT: 18</p> <p>BACK WIDTH: 20</p> <p>BACK HEIGHT: 16</p> <p>COM: 3 YD</p> <p>WEIGHT: 62 LB</p>
A/COM	B	C	D	E	F	G														
1165	1265	1325	1425	1535	1655	1785														
NEW MODEL 8104	GT	DOUBLE SEAT BENCH WITH TOP Bench seating for two with one table top	SWA	<table border="1"> <thead> <tr> <th>A/COM</th> <th>B</th> <th>C</th> <th>D</th> <th>E</th> <th>F</th> <th>G</th> </tr> </thead> <tbody> <tr> <td>1135</td> <td>1200</td> <td>1240</td> <td>1305</td> <td>1380</td> <td>1460</td> <td>1550</td> </tr> </tbody> </table>	A/COM	B	C	D	E	F	G	1135	1200	1240	1305	1380	1460	1550	<ul style="list-style-type: none"> • Molded Foam Seat and Back • Black and Gray Padded Arms • Clear Access Legs • Non-marring Adjustable Feet • Rated for 500 lbs 	<p>WIDTH: 65.5</p> <p>DEPTH: 23.5</p> <p>HEIGHT: 18</p> <p>SEAT WIDTH: 20</p> <p>SEAT DEPTH: 23.5</p> <p>SEAT HEIGHT: 18</p> <p>BACK WIDTH: 20</p> <p>BACK HEIGHT: 16</p> <p>COM: 2 YD</p> <p>WEIGHT: 62 LB</p>
A/COM	B	C	D	E	F	G														
1135	1200	1240	1305	1380	1460	1550														

LAMINATE COLORS

BLACK BKL	SLATE GRAY SGL	DESIGNER WHITE DWL
PLATINUM PTL	WALLABY WBL	

AVAILABLE FEBRUARY 2017

Standard 25 Day Lead Time: twenty five (25) business days applies to all Sophie models regardless of quantity. \$100 NET per shipment for Sophie orders of 3 chair model units or less.

sophie

ultimate comfort in a complete line of area seating

GSA SIN # 711-16

- Thick foam seat and back
- Robust design for the most rigorous public areas
- Removable seat and back cover
- Gray or black arm caps
- 6 powder coat frame colors
- Non-marring adjustable feet



CREATING SOPHIE MODEL NUMBER

MODEL NUMBER CONTROL ARMS FRAME COLOR GRADE PACKAGING OPTIONS
8 1 1 - **GT** - **A 8 0** - - - - **AC** - - -

* CHROME FRAME COLOR (CF) IS NO LONGER AVAILABLE AND HAS BEEN REPLACED WITH POLISHED ALUMINUM (PF)

FRAME COLORS

BLACK BF	SILVER SF	METALLIC BROWN MBF
GUNMETAL GMF	DOVER GRAY DGF	WHITE WF

NEW PATIENT SEATING

MODEL	CONTROL	DESCRIPTION	ARM	FABRIC	FEATURES	DIMENSIONS														
NEW MODEL 8118	GT	HIP CHAIR Hip chair with armrest	SWA	<table border="1"> <thead> <tr> <th>A/COM</th> <th>B</th> <th>C</th> <th>D</th> <th>E</th> <th>F</th> <th>G</th> </tr> </thead> <tbody> <tr> <td>895</td> <td>945</td> <td>975</td> <td>1025</td> <td>1080</td> <td>1140</td> <td>1205</td> </tr> </tbody> </table>	A/COM	B	C	D	E	F	G	895	945	975	1025	1080	1140	1205	<ul style="list-style-type: none"> • Molded Foam Seat and Back • Black and Gray Padded Arms • Clear Access Legs • Non-marring Adjustable Feet • Rated for 350 lbs 	WIDTH: 25 DEPTH: 29.5 HEIGHT: 41.75 SEAT WIDTH: 20 SEAT DEPTH: 19 SEAT HEIGHT: 26 BACK WIDTH: 20 BACK HEIGHT: 16 COM: 1.5 YD WEIGHT: 60 LB
A/COM	B	C	D	E	F	G														
895	945	975	1025	1080	1140	1205														
NEW MODEL 8119	GT	BARIATRIC Bariatric chair with armrest	SWA	<table border="1"> <thead> <tr> <th>A/COM</th> <th>B</th> <th>C</th> <th>D</th> <th>E</th> <th>F</th> <th>G</th> </tr> </thead> <tbody> <tr> <td>995</td> <td>1075</td> <td>1125</td> <td>1205</td> <td>1295</td> <td>1395</td> <td>1505</td> </tr> </tbody> </table>	A/COM	B	C	D	E	F	G	995	1075	1125	1205	1295	1395	1505	<ul style="list-style-type: none"> • Thick Foam Seat and Back • Black and Gray Padded Arms • Clear Access Legs • Non-marring Adjustable Feet • Rated for 500 lbs 	WIDTH: 35 DEPTH: 27.25 HEIGHT: 33.75 SEAT WIDTH: 30 SEAT DEPTH: 19 SEAT HEIGHT: 18 BACK WIDTH: 30 BACK HEIGHT: 16 COM: 2.5 YD WEIGHT: 66 LB
A/COM	B	C	D	E	F	G														
995	1075	1125	1205	1295	1395	1505														

ARM OPTIONS

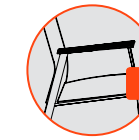

Black Soft Touch Polyurethane Pad

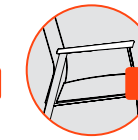

Gray Soft Touch Polyurethane Pad

AVAILABLE APRIL 2017

Standard 25 Day Lead Time: twenty five (25) business days applies to all Sophie models regardless of quantity. \$100 NET per shipment for Sophie orders of 3 chair model units or less.

sophie

ultimate comfort in a complete line of area seating

GSA SIN # 711-11 Pending

- 6 powder coat frame colors
- 5 laminate color choices

CREATING SOPHIE MODEL NUMBER







MODEL NUMBER CONTROL ARMS FRAME COLOR GRADE PACKAGING OPTIONS
8 1 1 - **G T** - **A 8 0** - - - - **A C** - - - -

* CHROME FRAME (C) OR (CF) IS NO LONGER AVAILABLE AND HAS BEEN REPLACED WITH POLISHED ALUMINUM (PF)

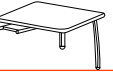
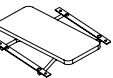
FRAME COLORS

BLACK BF	SILVER SF	METALLIC BROWN MBF
GUNMETAL GMF	DOVER GRAY DMF	WHITE WF

NEW TABLES AND ACCESSORIES

MODEL	CONTROL	DESCRIPTION	ARM	FABRIC	FEATURES	DIMENSIONS
NEW MODEL 8190 	TB	24" END TABLE Square		260		WIDTH: 24 DEPTH: 24 HEIGHT: 16.25
NEW MODEL 8191 	TB	24" CONNECTING TABLE End-of-Run Connecting		255		WIDTH: 24 DEPTH: 24 HEIGHT: 13.5
NEW MODEL 8192 	TB	SUSPENSION TABLE 16" x 18" Rectangular		135		WIDTH: 27.75 DEPTH: 27.75 HEIGHT: 13.5
NEW MODEL 8193 	TB	SUSPENSION TABLE Round		295		WIDTH: 11 DEPTH: 18 HEIGHT: 13.5
NEW MODEL 8194 	TB	SUSPENSION TABLE 30 Degree Angled		140		WIDTH: 15 DEPTH: 18 HEIGHT: 13.5
NEW MODEL 8195 	TB	SUSPENSION TABLE 45 Degree Angled		145		WIDTH: 17 DEPTH: 19 HEIGHT: 13.5 LB
NEW MODEL 8196 	TB	SUSPENSION TABLE 60 Degree Angled		165		WIDTH: 16 DEPTH: 42 HEIGHT: 16.75
NEW MODEL 8170 	TB	RECTANGULAR TABLE 16" x 42" Rectangular		325		

LAMINATE COLORS

BLACK BKL	SLATE GRAY SGL	DESIGNER WHITE DWL
PLATINUM PTL	WALLABY WBL	

ADDITIONAL OPTIONS

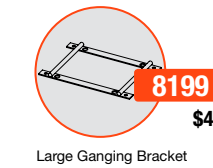

AVAILABLE FEBRUARY 2017

Standard 25 Day Lead Time: twenty five (25) business days applies to all Sophie models regardless of quantity. \$100 NET per shipment for Sophie orders of 3 chair model units or less.

strata LITE

let strata float into your office

BLACK COLORED ACCENTS AND BASE

GSA SIN # 711-18

- Task, task stool, executive and conference seating
- Warranted up to 250 lbs with Y1
- CAL TB 133 Fire Code approved
- Black Nylon Base



CREATING STRATA MODEL NUMBER

MODEL NUMBER CONTROL ARMS FRAME COLOR BACK MESH COLOR GRADE CASTERS PACKAGING OPTIONS

1 5 - Y 1 - A - B F - M 0 1 - C 4 -











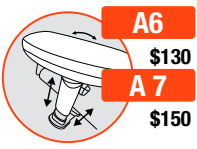

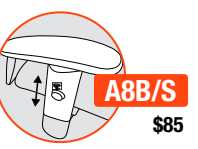
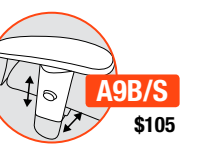



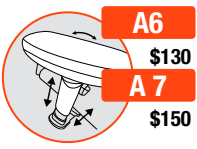

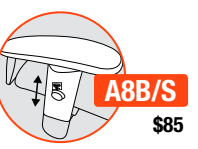
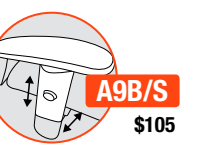



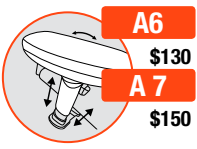

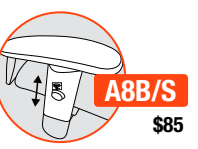
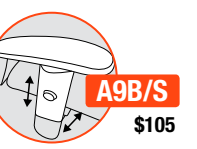
* FOR ARMLESS CODE USE A00

FRAME COLORS

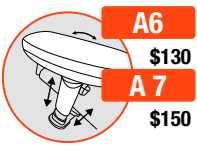
CODE	DESCRIPTION
BF	BLACK

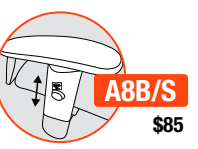
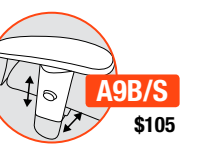
PACKAGING NOTES

CODE	DESCRIPTION	LIST UPCHARGE
AB	ASSEMBLED IN BAG FOR WILL CALL	\$0
PAC	PARTIALLY ASSEMBLED IN CARTON	\$0
BAC	BACK ASSEMBLED IN CARTON	\$40

MODEL	CONTROL	DESCRIPTION	ARM	FABRIC/LEATHER											FEATURES	DIMENSIONS	ARM OPTIONS	CASTER OPTIONS	ADDITIONAL OPTIONS	
				T01	A/COM	B	C	D	E	F	G	L3/COL	L4	L5						
1545	Y1	MID-BACK SIMPLE SYNCHRO TILT CONTROL Use for a variety of general office seating, including private office and conference room seating.	ARMLESS	485	540	570	590	620	655	695	735	665	735	790	<ul style="list-style-type: none"> • Pneumatic Seat Height Adjustment • Tilt Tension Control • Back and Seat Tilt in 3:1 Ratio • Upright Position Tilt Lock • Height and Depth Adjustable Lumbar • Rated for 250lbs 	WIDTH: 26.5 DEPTH: 26.5 HEIGHT: 39.5-44.0 SEAT WIDTH: 21.0 SEAT DEPTH: 18.0 SEAT HEIGHT: 17.0-21.5 BACK WIDTH: 21.0 BACK HEIGHT: 22.0 COM: 0.9 YDS COL: 13.0 SQ FT WEIGHT: 46.0 LB	 A6 \$130  A7 \$150  A8B/S \$85  A9B/S \$105	 A10 \$85  A36 \$105  A37 \$125	C4 STD Standard 60mm Hoodless Casters	BA2B \$100 BA2P BA2S \$100 SS \$60
			A6	615	670	700	720	750	785	825	865	795	865	920						
			A7	635	690	720	740	770	805	845	885	815	885	940						
			A8B / A8S	570	625	655	675	705	740	780	820	750	820	875						
			A9B / A9S	590	645	675	695	725	760	800	840	770	840	895						
			A10	570	625	655	675	705	740	780	820	750	820	875						
A36	590	645	675	695	725	760	800	840	770	840	895									
A37	610	665	695	715	745	780	820	860	790	860	915	SEAT SLIDER (SS) - ADD \$60								
1555	Y1	HIGH-BACK W/ HEADREST SIMPLE SYNCHRO TILT CONTROL Use for a variety of general office seating, including private office and conference room seating.	ARMLESS	540	600	630	650	680	715	755	795	725	845	900	<ul style="list-style-type: none"> • Pneumatic Seat Height Adjustment • Tilt Tension Control • Back and Seat Tilt in 3:1 Ratio • Upright Position Tilt Lock • Height and Depth Adjustable Lumbar • Height and Tilt Adjustable Headrest • Rated for 250lbs 	WIDTH: 26.5 DEPTH: 26.5 HEIGHT: 46.5-51.0 SEAT WIDTH: 21.0 SEAT DEPTH: 18.0 SEAT HEIGHT: 17.0-21.5 BACK WIDTH: 21.0 BACK HEIGHT: 29.0 COM: 0.9 YDS COL: 16.0 SQ FT WEIGHT: 47.0 LB	 A6 \$130  A7 \$150  A8B/S \$85  A9B/S \$105	 A10 \$85  A36 \$105  A37 \$125	C4 STD Standard 60mm Hoodless Casters	BA2B \$100 BA2P BA2S \$100 SS \$60
			A6	670	730	760	780	810	845	885	925	855	975	1030						
			A7	690	750	780	800	830	865	905	945	875	995	1050						
			A8B / A8S	625	685	715	735	765	800	840	880	810	930	985						
			A9B / A9S	645	705	735	755	785	820	860	900	830	950	1005						
			A10	625	685	715	735	765	800	840	880	810	930	985						
A36	645	705	735	755	785	820	860	900	830	950	1005									
A37	665	725	755	775	805	840	880	920	850	970	1025	SEAT SLIDER (SS) - ADD \$60								
1546	Y1	10" TRAVEL HIGH STOOL SIMPLE SYNCHRO TILT CONTROL Use for work surfaces up to 42 inches high.	ARMLESS	610	665	695	715	745	780	820	860	790	860	915	<ul style="list-style-type: none"> • Pneumatic Seat Height Adjustment • Tilt Tension Control • Back and Seat Tilt in 3:1 Ratio • Upright Position Tilt Lock • Height and Depth Adjustable Lumbar • Rated for 250lbs 	WIDTH: 26.5 DEPTH: 26.5 HEIGHT: 49.0-59.0 SEAT WIDTH: 21.0 SEAT DEPTH: 18.0 SEAT HEIGHT: 27.0-37.0 BACK WIDTH: 21.0 BACK HEIGHT: 22.0 COM: 0.9 YDS COL: 13.0 SQ FT WEIGHT: 56.0 LB	 A6 \$130  A7 \$150  A8B/S \$85  A9B/S \$105	 A10 \$85  A36 \$105  A37 \$125	C4 STD Standard 60mm Hoodless Casters	BA2B \$100 BA2P BA2S \$100 SS \$60
			A6	740	795	825	845	875	910	950	990	920	990	1045						
			A7	760	815	845	865	895	930	970	1010	940	1010	1065						
			A8B / A8S	695	750	780	800	830	865	905	945	875	945	1000						
			A9B / A9S	715	770	800	820	850	885	925	965	895	965	1020						
			A10	695	750	780	800	830	865	905	945	875	945	1000						
A36	715	770	800	820	850	885	925	965	895	965	1020									
A37	735	790	820	840	870	905	945	985	915	985	1040	SEAT SLIDER (SS) - NOT AVAILABLE								
1548	Y1	8" TRAVEL LOW STOOL SIMPLE SYNCHRO TILT CONTROL Use for work surfaces up to 36 inches high.	ARMLESS	610	665	695	715	745	780	820	860	790	860	915	<ul style="list-style-type: none"> • Pneumatic Seat Height Adjustment • Tilt Tension Control • Back and Seat Tilt in 3:1 Ratio • Upright Position Tilt Lock • Height and Depth Adjustable Lumbar • Rated for 250lbs 	WIDTH: 26.5 DEPTH: 26.5 HEIGHT: 45.0-53.0 SEAT WIDTH: 21.0 SEAT DEPTH: 18.0 SEAT HEIGHT: 23.0-31.0 BACK WIDTH: 21.0 BACK HEIGHT: 22.0 COM: 0.9 YDS COL: 13.0 SQ FT WEIGHT: 55.0 LB	 A6 \$130  A7 \$150  A8B/S \$85  A9B/S \$105	 A10 \$85  A36 \$105  A37 \$125	C4 STD Standard 60mm Hoodless Casters	BA2B \$100 BA2P BA2S \$100 SS \$60
			A6	740	795	825	845	875	910	950	990	920	990	1045						
			A7	760	815	845	865	895	930	970	1010	940	1010	1065						
			A8B / A8S	695	750	780	800	830	865	905	945	875	945	1000						
			A9B / A9S	715	770	800	820	850	885	925	965	895	965	1020						
			A10	695	750	780	800	830	865	905	945	875	945	1000						
A36	715	770	800	820	850	885	925	965	895	965	1020									
A37	735	790	820	840	870	905	945	985	915	985	1040	SEAT SLIDER (SS) - NOT AVAILABLE								

strata

let strata float into your office

MESH BACK UPHOLSTERED SEAT

GSA SIN # 711-18

- Task, task stool, executive and conference seating
- Aluminum base standard
- Warranted up to 250 lbs with GT and stool
- Warranted up to 300 lbs with Y2 except for stool
- CAL TB 133 Fire Code approved
- Black or silver accents



CREATING STRATA MODEL NUMBER

MODEL NUMBER	CONTROL	ARMS	FRAME COLOR	BACK MESH COLOR	GRADE	CASTERS	PACKAGING	OPTIONS
15	Y2	A	F	M	O1	C4		

* FOR ARMLESS CODE USE A00

FRAME COLORS







CODE	DESCRIPTION
BF	BLACK
SF	SILVER

PACKAGING NOTES

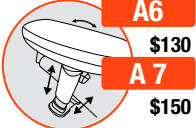
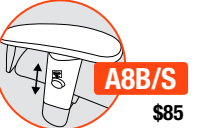
CODE	DESCRIPTION	LIST UPCHARGE
AB	ASSEMBLED IN BAG FOR WILL CALL	\$0
PAC	PARTIALLY ASSEMBLED IN CARTON	\$0
BAC	BACK ASSEMBLED IN CARTON	\$40

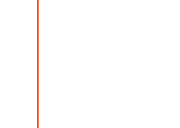
MODEL	CONTROL	DESCRIPTION	ARM	FABRIC/LEATHER											FEATURES	DIMENSIONS
				T01	A/COM	B	C	D	E	F	G	L3/COL	L4	L5		
1560	Y2	MID-BACK HEAVY DUTY SYNCHRO TILT CONTROL Use for a variety of general office seating, including private office and conference room seating.	ARMLESS	610	665	695	715	745	780	820	860	790	860	915	<ul style="list-style-type: none"> • Pneumatic Seat Height Adjustment • Side Tilt Tension Control • Back and Seat Tilt in 2:1 ratio • 4 Locking Positions • Safety Tilt Release • Height and Depth Adjustable Lumbar • Rated for 300 lbs 	WIDTH: 26.5 DEPTH: 26.5 HEIGHT: 39.5-44.0 SEAT WIDTH: 21.0 SEAT DEPTH: 18.0 SEAT HEIGHT: 17.0-21.5 BACK WIDTH: 21.0 BACK HEIGHT: 22.0 COM: 0.9 YDS COL: 13.0 SQ FT WEIGHT: 50.0 LB
A6	740		795	825	845	875	910	950	990	920	990	1045				
A7	760		815	845	865	895	930	970	1010	940	1010	1065				
A8B / A8S	695		750	780	800	830	865	905	945	875	945	1000				
A9B / A9S	715		770	800	820	850	885	925	965	895	965	1020				
A10	695		750	780	800	830	865	905	945	875	945	1000				
A36	715		770	800	820	850	885	925	965	895	965	1020				
A37	735	790	820	840	870	905	945	985	915	985	1040					
				SEAT SLIDER (SS) - ADD \$60												
1580	Y2	HIGH-BACK W/ HEADREST HEAVY DUTY SYNCHRO TILT CONTROL Use for a variety of general office seating, including private office and conference room seating.	ARMLESS	665	725	755	775	805	840	880	920	850	970	1025	<ul style="list-style-type: none"> • Pneumatic Seat Height Adjustment • Side Tilt Tension Control • Back and Seat Tilt in 2:1 ratio • 4 Locking Positions • Safety Tilt Release • Height and Depth Adjustable Lumbar • 2 Way Adjustable Headrest • Rated for 300 lbs 	WIDTH: 26.5 DEPTH: 26.5 HEIGHT: 46.5-51.0 SEAT WIDTH: 21.0 SEAT DEPTH: 18.0 SEAT HEIGHT: 17.0-21.5 BACK WIDTH: 21.0 BACK HEIGHT: 29.0 COM: 0.9 YDS COL: 16.0 SQ FT WEIGHT: 51.0 LB
A6	795		855	885	905	935	970	1010	1050	980	1100	1155				
A7	815		875	905	925	955	990	1030	1070	1000	1120	1175				
A8B / A8S	750		810	840	860	890	925	965	1005	935	1055	1110				
A9B / A9S	770		830	860	880	910	945	985	1025	955	1075	1130				
A10	750		810	840	860	890	925	965	1005	935	1055	1110				
A36	770		830	860	880	910	945	985	1025	955	1075	1130				
A37	790	850	880	900	930	965	1005	1045	975	1095	1150					
				SEAT SLIDER (SS) - ADD \$60												
1566	Y2	10" TRAVEL HIGH STOOL HEAVY DUTY SYNCHRO TILT CONTROL Use for work surfaces up to 42 inches high.	ARMLESS	735	790	820	840	870	905	945	985	910	980	1035	<ul style="list-style-type: none"> • Pneumatic Seat Height Adjustment • Side Tilt Tension Control • Back and Seat Tilt in 2:1 ratio • 4 Locking Positions • Safety Tilt Release • Height and Depth Adjustable Lumbar • Height Adj 20" Diameter Footring • Rated for 250 lbs 	WIDTH: 26.5 DEPTH: 26.5 HEIGHT: 49.0-59.0 SEAT WIDTH: 21.0 SEAT DEPTH: 18.0 SEAT HEIGHT: 27.0-37.0 BACK WIDTH: 21.0 BACK HEIGHT: 22.0 COM: 0.9 YDS COL: 13.0 SQ FT WEIGHT: 52.0 LB
A6	865		920	950	970	1000	1035	1075	1115	1040	1110	1165				
A7	885		940	970	990	1020	1055	1095	1135	1060	1130	1185				
A8B / A8S	820		875	905	925	955	990	1030	1070	995	1065	1120				
A9B / A9S	840		895	925	945	975	1010	1050	1090	1015	1085	1140				
A10	820		875	905	925	955	990	1030	1070	995	1065	1120				
A36	840		895	925	945	975	1010	1050	1090	1015	1085	1140				
A37	860	915	945	965	995	1030	1070	1110	1035	1105	1160					
				SEAT SLIDER (SS) - NOT AVAILABLE												
1568	Y2	8" TRAVEL LOW STOOL HEAVY DUTY SYNCHRO TILT CONTROL Use for work surfaces up to 36 inches high.	ARMLESS	735	790	820	840	870	905	945	985	910	980	1035	<ul style="list-style-type: none"> • Pneumatic Seat Height Adjustment • Side Tilt Tension Control • Back and Seat Tilt in 2:1 ratio • 4 Locking Positions • Safety Tilt Release • Height and Depth Adjustable Lumbar • Height Adj 20" Diameter Footring • Rated for 250 lbs 	WIDTH: 26.5 DEPTH: 26.5 HEIGHT: 45.0-53.0 SEAT WIDTH: 21.0 SEAT DEPTH: 18.0 SEAT HEIGHT: 23.0-31.0 BACK WIDTH: 21.0 BACK HEIGHT: 22.0 COM: 0.9 YDS COL: 13.0 SQ FT WEIGHT: 49.5 LB
A6	865		920	950	970	1000	1035	1075	1115	1040	1110	1165				
A7	885		940	970	990	1020	1055	1095	1135	1060	1130	1185				
A8B / A8S	820		875	905	925	955	990	1030	1070	995	1065	1120				
A9B / A9S	840		895	925	945	975	1010	1050	1090	1015	1085	1140				
A10	820		875	905	925	955	990	1030	1070	995	1065	1120				
A36	840		895	925	945	975	1010	1050	1090	1015	1085	1140				
A37	860	915	945	965	995	1030	1070	1110	1035	1105	1160					
				SEAT SLIDER (SS) - NOT AVAILABLE												

ARM OPTIONS

 <p>A6 \$130</p>	 <p>A7 \$150</p>	 <p>A8B/S \$85</p>	 <p>A9B/S \$105</p>
 <p>A10 \$85</p>	 <p>A36 \$105</p>	 <p>A37 \$125</p>	

Forward abd back sliding Ura-Soft® arm with swivel pad, and adjustable arm pad position.

2-Way Adjustable Arm Height Adjustable A8B Black or A8S Silver

4-Way Adjustable Arm Height Adjustable and 4" Interior Width Adjustment A9B Black or A9S Silver

Black Soft Touch Cantilever style C-Shaped Arm

8-Way Adjustable Arms Soft-Touch sliding and pivoting arm pads.

10-Way Adjustable Arms Soft-Touch sliding and pivoting arm pads and 4" arm width knob under seat.

CASTER OPTIONS

 <p>C4 STD</p>	 <p>C1S \$35</p>	 <p>C2S \$35</p>
--	--	--

Standard 60mm Hoodless Casters

50mm Hooded Hard Floor Casters

50mm Hooded Self-Locking Hard Floor Casters

ADDITIONAL OPTIONS

 <p>BA2B BA2S STD</p>	 <p>BA2P \$100</p>	 <p>SS \$60</p>
---	--	---

27" Aluminum Base BA2B, Black Powder-Coated BA2S, Silver Powder-Coated

27" POLISHED Aluminum Base

Seat Slider 2.5" Side Paddle Activated

ACCENT COLORS

BLACK	BF
SILVER	SF



HD
\$50

Heavy Duty Multi-Shift Upgrade 350 lb

strata

let strata float into your office

GSA SIN # 711-18

- Multi-Purpose Guest seating
- Warranted up to 250 lbs with GT
- CAL TB 133 Fire Code approved



MESH BACK UPHOLSTERED SEAT

CREATING STRATA MODEL NUMBER

MODEL NUMBER CONTROL ARMS FRAME COLOR BACK MESH COLOR GRADE PACKAGING
1 5 6 0 - G T - S W A - S F - M 0 1 -

FRAME COLORS

CODE	DESCRIPTION
SF	SILVER

PACKAGING NOTES

CODE	DESCRIPTION	LIST UPCHARGE
AB	ASSEMBLED IN BAG FOR WILL CALL	\$0
PAC	PARTIALLY ASSEMBLED IN CARTON	\$0
BAC	BACK ASSEMBLED IN CARTON	\$40

MODEL CONTROL DESCRIPTION

1560

GT

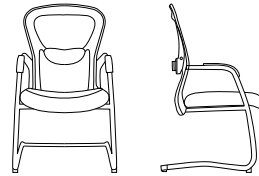

GUEST

Silver cantilever steel frame side chair.

ARM FABRIC/LEATHER

SWA

T01	A/COM	B	C	D	E	F	G	L3/COL	L4	L5
500	555	585	605	635	670	710	750	680	750	805

SHIPS FULLY ASSEMBLED EITHER AC OR AB / SWA - STANDARD WITH ARMS

FEATURES

- Height and Depth Adjustable Lumbar
- Silver Chair Back Accents
- Black Four Leg Style Frame
- Rated for 250 lbs

DIMENSIONS

WIDTH:	24.0
DEPTH:	24.0
HEIGHT:	39.0
SEAT WIDTH:	21.0
SEAT DEPTH:	18.0
SEAT HEIGHT:	18.0
BACK WIDTH:	21.0
BACK HEIGHT:	22.0
COM:	0.9 YDS
COL:	13.0 SQ FT
WEIGHT:	28.0 LB

ARM OPTIONS



Standard with Arms

strata all mesh

let strata float into your office

LITE

GSA SIN # 711-18

- Task, task stool, executive and conference seating
- Warranted up to 250 lbs with Y1
- Black Nylon Base



CREATING STRATA ALL MESH MODEL NUMBER

MODEL NUMBER CONTROL ARMS FRAME COLOR BACK MESH COLOR GRADE CASTERS PACKAGING OPTIONS

1 5 - Y 1 - A - B F - M 0 1 - C 4 -

* FOR ARMLESS CODE USE A00

FRAME COLORS

CODE	DESCRIPTION
BF	BLACK

PACKAGING NOTES

CODE	DESCRIPTION	LIST UPCHARGE
AB	ASSEMBLED IN BAG FOR WILL CALL	\$0
PAC	PARTIALLY ASSEMBLED IN CARTON	\$0
BAC	BACK ASSEMBLED IN CARTON	\$40

BLACK COLORED ACCENTS AND BASE

MODEL	CONTROL	DESCRIPTION	ARM	MESH	FEATURES	DIMENSIONS	ARM OPTIONS																																
1535	Y1	MID-BACK SIMPLE SYNCHRO TILT CONTROL Use for a variety of general office seating, including private office and conference room seating.	<table border="1"> <tr><td>ARMLESS</td><td>540</td></tr> <tr><td>A6</td><td>670</td></tr> <tr><td>A7</td><td>690</td></tr> <tr><td>A8B / A8S</td><td>625</td></tr> <tr><td>A9B / A9S</td><td>645</td></tr> <tr><td>A10</td><td>625</td></tr> <tr><td>A36</td><td>645</td></tr> <tr><td>A37</td><td>665</td></tr> </table>	ARMLESS	540	A6	670	A7	690	A8B / A8S	625	A9B / A9S	645	A10	625	A36	645	A37	665	<table border="1"> <tr><td>M</td><td>540</td></tr> <tr><td>M</td><td>670</td></tr> <tr><td>M</td><td>690</td></tr> <tr><td>M</td><td>625</td></tr> <tr><td>M</td><td>645</td></tr> <tr><td>M</td><td>625</td></tr> <tr><td>M</td><td>645</td></tr> <tr><td>M</td><td>665</td></tr> </table>	M	540	M	670	M	690	M	625	M	645	M	625	M	645	M	665	<ul style="list-style-type: none"> • Pneumatic Seat Height Adjustment • Tilt Tension Control • Back and Seat Tilt in 3:1 Ratio • Upright Position Tilt Lock • Height and Depth Adjustable Lumbar • Rated for 250 lbs 	<p>WIDTH: 26.5 DEPTH: 26.5 HEIGHT: 39.5-44.0 SEAT WIDTH: 19.0 SEAT DEPTH: 18.0 SEAT HEIGHT: 17.0-21.5 BACK WIDTH: 21.0 BACK HEIGHT: 22.0 WEIGHT: 46.0 LB</p>	<p>A6 \$130 A7 \$150</p> <p>Forward abd back sliding Ura-Soft® arm with swivel pad, and adjustable arm pad position.</p> <p>A8B/S \$85 A9B/S \$105</p> <p>2-Way Adjustable Arm Height Adjustable A8B Black or A8S Silver</p> <p>4-Way Adjustable Arm Height Adjustable and 4" Interior Width Adjustment A9B Black or A9S Silver</p>
ARMLESS	540																																						
A6	670																																						
A7	690																																						
A8B / A8S	625																																						
A9B / A9S	645																																						
A10	625																																						
A36	645																																						
A37	665																																						
M	540																																						
M	670																																						
M	690																																						
M	625																																						
M	645																																						
M	625																																						
M	645																																						
M	665																																						
1537	Y1	HIGH-BACK W/ HEADREST SIMPLE SYNCHRO TILT CONTROL Use for a variety of general office seating, including private office and conference room seating.	<table border="1"> <tr><td>ARMLESS</td><td>595</td></tr> <tr><td>A6</td><td>725</td></tr> <tr><td>A7</td><td>745</td></tr> <tr><td>A8B / A8S</td><td>680</td></tr> <tr><td>A9B / A9S</td><td>700</td></tr> <tr><td>A10</td><td>680</td></tr> <tr><td>A36</td><td>700</td></tr> <tr><td>A37</td><td>720</td></tr> </table>	ARMLESS	595	A6	725	A7	745	A8B / A8S	680	A9B / A9S	700	A10	680	A36	700	A37	720	<table border="1"> <tr><td>M</td><td>595</td></tr> <tr><td>M</td><td>725</td></tr> <tr><td>M</td><td>745</td></tr> <tr><td>M</td><td>680</td></tr> <tr><td>M</td><td>700</td></tr> <tr><td>M</td><td>680</td></tr> <tr><td>M</td><td>700</td></tr> <tr><td>M</td><td>720</td></tr> </table>	M	595	M	725	M	745	M	680	M	700	M	680	M	700	M	720	<ul style="list-style-type: none"> • Pneumatic Seat Height Adjustment • Tilt Tension Control • Back and Seat Tilt in 3:1 Ratio • Upright Position Tilt Lock • Height and Depth Adjustable Lumbar • Height and Tilt Adjustable Headrest • Rated for 250 lbs 	<p>WIDTH: 26.5 DEPTH: 26.5 HEIGHT: 46.5-51.0 SEAT WIDTH: 19.0 SEAT DEPTH: 18.0 SEAT HEIGHT: 17.0-21.5 BACK WIDTH: 21.0 BACK HEIGHT: 29.0 WEIGHT: 47.0 LB</p>	<p>A10 \$85 A36 \$105 A37 \$125</p> <p>Black Soft Touch Cantilever style C-Shaped Arm</p> <p>8-Way Adjustable Arms Soft-Touch sliding and pivoting arm pads.</p> <p>10 -Way Adjustable Arms Soft-Touch sliding and pivoting arm pads and 4" arm width knob under seat.</p>
ARMLESS	595																																						
A6	725																																						
A7	745																																						
A8B / A8S	680																																						
A9B / A9S	700																																						
A10	680																																						
A36	700																																						
A37	720																																						
M	595																																						
M	725																																						
M	745																																						
M	680																																						
M	700																																						
M	680																																						
M	700																																						
M	720																																						
1536	Y1	10" TRAVEL HIGH STOOL SIMPLE SYNCHRO TILT CONTROL Use for work surfaces up to 42 inches high.	<table border="1"> <tr><td>ARMLESS</td><td>665</td></tr> <tr><td>A6</td><td>795</td></tr> <tr><td>A7</td><td>815</td></tr> <tr><td>A8B / A8S</td><td>750</td></tr> <tr><td>A9B / A9S</td><td>770</td></tr> <tr><td>A10</td><td>750</td></tr> <tr><td>A36</td><td>770</td></tr> <tr><td>A37</td><td>790</td></tr> </table>	ARMLESS	665	A6	795	A7	815	A8B / A8S	750	A9B / A9S	770	A10	750	A36	770	A37	790	<table border="1"> <tr><td>M</td><td>665</td></tr> <tr><td>M</td><td>795</td></tr> <tr><td>M</td><td>815</td></tr> <tr><td>M</td><td>750</td></tr> <tr><td>M</td><td>770</td></tr> <tr><td>M</td><td>750</td></tr> <tr><td>M</td><td>770</td></tr> <tr><td>M</td><td>790</td></tr> </table>	M	665	M	795	M	815	M	750	M	770	M	750	M	770	M	790	<ul style="list-style-type: none"> • Pneumatic Seat Height Adjustment • Tilt Tension Control • Back and Seat Tilt in 3:1 Ratio • Upright Position Tilt Lock • Height and Depth Adjustable Lumbar • Rated for 250 lbs 	<p>WIDTH: 26.5 DEPTH: 26.5 HEIGHT: 49.0-59.0 SEAT WIDTH: 19.0 SEAT DEPTH: 18.0 SEAT HEIGHT: 27.0-37.0 BACK WIDTH: 21.0 BACK HEIGHT: 22.0 WEIGHT: 56.0 LB</p>	<p>BA2P \$100 BA2S \$100 BA2B \$100</p> <p>27" Aluminum Base BA2B, Black Powder-Coated BA2P, Polished BA2S, Silver Powder-Coated</p> <p>SS \$60</p> <p>Seat Slider 2.5" Side Paddle Activated factory installed</p>
ARMLESS	665																																						
A6	795																																						
A7	815																																						
A8B / A8S	750																																						
A9B / A9S	770																																						
A10	750																																						
A36	770																																						
A37	790																																						
M	665																																						
M	795																																						
M	815																																						
M	750																																						
M	770																																						
M	750																																						
M	770																																						
M	790																																						
1538	Y1	8" TRAVEL LOW STOOL SIMPLE SYNCHRO TILT CONTROL Use for work surfaces up to 36 inches high.	<table border="1"> <tr><td>ARMLESS</td><td>665</td></tr> <tr><td>A6</td><td>795</td></tr> <tr><td>A7</td><td>815</td></tr> <tr><td>A8B / A8S</td><td>750</td></tr> <tr><td>A9B / A9S</td><td>770</td></tr> <tr><td>A10</td><td>750</td></tr> <tr><td>A36</td><td>770</td></tr> <tr><td>A37</td><td>790</td></tr> </table>	ARMLESS	665	A6	795	A7	815	A8B / A8S	750	A9B / A9S	770	A10	750	A36	770	A37	790	<table border="1"> <tr><td>M</td><td>665</td></tr> <tr><td>M</td><td>795</td></tr> <tr><td>M</td><td>815</td></tr> <tr><td>M</td><td>750</td></tr> <tr><td>M</td><td>770</td></tr> <tr><td>M</td><td>750</td></tr> <tr><td>M</td><td>770</td></tr> <tr><td>M</td><td>790</td></tr> </table>	M	665	M	795	M	815	M	750	M	770	M	750	M	770	M	790	<ul style="list-style-type: none"> • Pneumatic Seat Height Adjustment • Tilt Tension Control • Back and Seat Tilt in 3:1 Ratio • Upright Position Tilt Lock • Height and Depth Adjustable Lumbar • Rated for 250 lbs 	<p>WIDTH: 26.5 DEPTH: 26.5 HEIGHT: 45.0-53.0 SEAT WIDTH: 19.0 SEAT DEPTH: 18.0 SEAT HEIGHT: 23.0-31.0 BACK WIDTH: 21.0 BACK HEIGHT: 22.0 WEIGHT: 55.0 LB</p>	<p>BA2P \$100 BA2S \$100 BA2B \$100</p> <p>27" Aluminum Base BA2B, Black Powder-Coated BA2P, Polished BA2S, Silver Powder-Coated</p> <p>SS \$60</p> <p>Seat Slider 2.5" Side Paddle Activated factory installed</p>
ARMLESS	665																																						
A6	795																																						
A7	815																																						
A8B / A8S	750																																						
A9B / A9S	770																																						
A10	750																																						
A36	770																																						
A37	790																																						
M	665																																						
M	795																																						
M	815																																						
M	750																																						
M	770																																						
M	750																																						
M	770																																						
M	790																																						

strata all mesh

let strata float into your office

ALL MESH

GSA SIN # 711-18

- Task, task stool, executive and conference seating
- Aluminum base standard
- Warranted up to 250 lbs with GT and stool
- Warranted up to 300 lbs with Y2 except for stool
- Black or silver accents



CREATING STRATA ALL MESH MODEL NUMBER

MODEL NUMBER CONTROL ARMS FRAME COLOR BACK MESH COLOR GRADE CASTERS PACKAGING OPTIONS

1 5 - Y 2 - A - F - M 0 1 - C 4

* FOR ARMLESS CODE USE A00

FRAME COLORS

CODE	DESCRIPTION
BF	BLACK

PACKAGING NOTES

CODE	DESCRIPTION	LIST UPCHARGE
AB	ASSEMBLED IN BAG FOR WILL CALL	\$0
PAC	PARTIALLY ASSEMBLED IN CARTON	\$0
BAC	BACK ASSEMBLED IN CARTON	\$40

MODEL	CONTROL	DESCRIPTION	ARM	MESH	FEATURES	DIMENSIONS	ARM OPTIONS																																				
1570	Y2	MID-BACK HEAVY DUTY SYNCHRO TILT CONTROL Use for a variety of general office seating, including private office and conference room seating.	<table border="1"> <tr><td>ARMLESS</td><td>665</td></tr> <tr><td>A6</td><td>795</td></tr> <tr><td>A7</td><td>815</td></tr> <tr><td>A8B / A8S</td><td>750</td></tr> <tr><td>A9B / A9S</td><td>770</td></tr> <tr><td>A10</td><td>750</td></tr> <tr><td>A36</td><td>770</td></tr> <tr><td>A37</td><td>790</td></tr> </table>	ARMLESS	665	A6	795	A7	815	A8B / A8S	750	A9B / A9S	770	A10	750	A36	770	A37	790	<table border="1"> <tr><td>M</td><td></td></tr> <tr><td></td><td></td></tr> <tr><td></td><td></td></tr> <tr><td></td><td></td></tr> <tr><td></td><td></td></tr> <tr><td></td><td></td></tr> <tr><td></td><td></td></tr> <tr><td></td><td></td></tr> <tr><td></td><td></td></tr> <tr><td></td><td></td></tr> </table>	M																				<ul style="list-style-type: none"> • Pneumatic Seat Height Adjustment • Side Tilt Tension Control • Back and Seat Tilt in 2:1 ratio • 4 Locking Positions • Safety Tilt Release • Height and Depth Adjustable Lumbar • Rated for 300 lbs 	WIDTH: 26.5 DEPTH: 26.5 HEIGHT: 39.5-44.0 SEAT WIDTH: 19.0 SEAT DEPTH: 18.0 SEAT HEIGHT: 17.0-21.5 BACK WIDTH: 21.0 BACK HEIGHT: 22.0 WEIGHT: 50.0 LB	A6 \$130 A7 \$150 A8B/S \$85 A9B/S \$105 A10 \$85 A36 \$105 A37 \$125
ARMLESS	665																																										
A6	795																																										
A7	815																																										
A8B / A8S	750																																										
A9B / A9S	770																																										
A10	750																																										
A36	770																																										
A37	790																																										
M																																											
				SEAT SLIDER (SS) - ADD \$60 - FACTORY INSTALLED																																							
1590	Y2	HIGH-BACK W/ HEADREST HEAVY DUTY SYNCHRO TILT CONTROL Use for a variety of general office seating, including private office and conference room seating.	<table border="1"> <tr><td>ARMLESS</td><td>720</td></tr> <tr><td>A6</td><td>850</td></tr> <tr><td>A7</td><td>870</td></tr> <tr><td>A8B / A8S</td><td>805</td></tr> <tr><td>A9B / A9S</td><td>825</td></tr> <tr><td>A10</td><td>805</td></tr> <tr><td>A36</td><td>825</td></tr> <tr><td>A37</td><td>845</td></tr> </table>	ARMLESS	720	A6	850	A7	870	A8B / A8S	805	A9B / A9S	825	A10	805	A36	825	A37	845	<table border="1"> <tr><td>M</td><td></td></tr> <tr><td></td><td></td></tr> <tr><td></td><td></td></tr> <tr><td></td><td></td></tr> <tr><td></td><td></td></tr> <tr><td></td><td></td></tr> <tr><td></td><td></td></tr> <tr><td></td><td></td></tr> <tr><td></td><td></td></tr> <tr><td></td><td></td></tr> </table>	M																				<ul style="list-style-type: none"> • Pneumatic Seat Height Adjustment • Side Tilt Tension Control • Back and Seat Tilt in 2:1 ratio • 4 Locking Positions • Safety Tilt Release • Height and Depth Adjustable Lumbar • 2 Way Adjustable Headrest • Rated for 300 lbs 	WIDTH: 26.5 DEPTH: 26.5 HEIGHT: 46.5-51.0 SEAT WIDTH: 19.0 SEAT DEPTH: 18.0 SEAT HEIGHT: 17.0-21.5 BACK WIDTH: 21.0 BACK HEIGHT: 22.0 WEIGHT: 51.0 LB	A10 \$85 A36 \$105 A37 \$125
ARMLESS	720																																										
A6	850																																										
A7	870																																										
A8B / A8S	805																																										
A9B / A9S	825																																										
A10	805																																										
A36	825																																										
A37	845																																										
M																																											
				SEAT SLIDER (SS) - ADD \$60 - FACTORY INSTALLED																																							
1576	Y2	10" TRAVEL HIGH STOOL HEAVY DUTY SYNCHRO TILT CONTROL Use for work surfaces up to 42 inches high.	<table border="1"> <tr><td>ARMLESS</td><td>790</td></tr> <tr><td>A6</td><td>920</td></tr> <tr><td>A7</td><td>940</td></tr> <tr><td>A8B / A8S</td><td>875</td></tr> <tr><td>A9B / A9S</td><td>895</td></tr> <tr><td>A10</td><td>875</td></tr> <tr><td>A36</td><td>895</td></tr> <tr><td>A37</td><td>915</td></tr> </table>	ARMLESS	790	A6	920	A7	940	A8B / A8S	875	A9B / A9S	895	A10	875	A36	895	A37	915	<table border="1"> <tr><td>M</td><td></td></tr> <tr><td></td><td></td></tr> <tr><td></td><td></td></tr> <tr><td></td><td></td></tr> <tr><td></td><td></td></tr> <tr><td></td><td></td></tr> <tr><td></td><td></td></tr> <tr><td></td><td></td></tr> <tr><td></td><td></td></tr> <tr><td></td><td></td></tr> </table>	M																				<ul style="list-style-type: none"> • Pneumatic Seat Height Adjustment • Side Tilt Tension Control • Back and Seat Tilt in 2:1 ratio • 4 Locking Positions • Safety Tilt Release • Height and Depth Adjustable Lumbar • Height Adj 20" Diameter Footring • Rated for 250 lbs 	WIDTH: 26.5 DEPTH: 26.5 HEIGHT: 49.0-59.0 SEAT WIDTH: 19.0 SEAT DEPTH: 18.0 SEAT HEIGHT: 27.0-37.0 BACK WIDTH: 21.0 BACK HEIGHT: 22.0 WEIGHT: 52.0 LB	SS \$60 HD \$50 BA2P BA2S BA2B STD
ARMLESS	790																																										
A6	920																																										
A7	940																																										
A8B / A8S	875																																										
A9B / A9S	895																																										
A10	875																																										
A36	895																																										
A37	915																																										
M																																											
				SEAT SLIDER (SS) - NOT AVAILABLE																																							
1578	Y2	8" TRAVEL LOW STOOL HEAVY DUTY SYNCHRO TILT CONTROL Use for work surfaces up to 36 inches high.	<table border="1"> <tr><td>ARMLESS</td><td>790</td></tr> <tr><td>A6</td><td>920</td></tr> <tr><td>A7</td><td>940</td></tr> <tr><td>A8B / A8S</td><td>875</td></tr> <tr><td>A9B / A9S</td><td>895</td></tr> <tr><td>A10</td><td>875</td></tr> <tr><td>A36</td><td>895</td></tr> <tr><td>A37</td><td>915</td></tr> </table>	ARMLESS	790	A6	920	A7	940	A8B / A8S	875	A9B / A9S	895	A10	875	A36	895	A37	915	<table border="1"> <tr><td>M</td><td></td></tr> <tr><td></td><td></td></tr> <tr><td></td><td></td></tr> <tr><td></td><td></td></tr> <tr><td></td><td></td></tr> <tr><td></td><td></td></tr> <tr><td></td><td></td></tr> <tr><td></td><td></td></tr> <tr><td></td><td></td></tr> <tr><td></td><td></td></tr> </table>	M																				<ul style="list-style-type: none"> • Pneumatic Seat Height Adjustment • Side Tilt Tension Control • Back and Seat Tilt in 2:1 ratio • 4 Locking Positions • Safety Tilt Release • Height and Depth Adjustable Lumbar • Height Adj 20" Diameter Footring • Rated for 250 lbs 	WIDTH: 26.5 DEPTH: 26.5 HEIGHT: 45.0-53.0 SEAT WIDTH: 19.0 SEAT DEPTH: 18.0 SEAT HEIGHT: 23.0-31.0 BACK WIDTH: 21.0 BACK HEIGHT: 22.0 WEIGHT: 49.5 LB	SS \$60 HD \$50 BA2P BA2S BA2B STD
ARMLESS	790																																										
A6	920																																										
A7	940																																										
A8B / A8S	875																																										
A9B / A9S	895																																										
A10	875																																										
A36	895																																										
A37	915																																										
M																																											
				SEAT SLIDER (SS) - NOT AVAILABLE																																							

* Not compatible with BA9

theory

the facts support theory as the smart choice

MESH BACK

GSA SIN # 711-18

- Task and conference seating
- Choice of 14 back mesh colors
- Warranted up to 250 lbs on Y1 and GT
- Warranted up to 300 lbs on Y2 and Y3
- Black nylon base
- Ratchet back adjustment with independent adjustable lumbar



CREATING THEORY MODEL NUMBER

MODEL NUMBER CONTROL ARMS BACK MESH COLOR GRADE CASTERS PACKAGING OPTIONS
2 1 6 0 - Y - A - M - C 6 - - - - -
* FOR ARMLESS CODE USE ADD

PACKAGING NOTES

CODE	DESCRIPTION	LIST UPCHARGE
AB	ASSEMBLED IN BAG FOR WILL CALL	\$0
PAC	PARTIALLY ASSEMBLED IN CARTON	\$0
BAC	BACK ASSEMBLED IN CARTON	\$40

MODEL	CONTROL	DESCRIPTION	MESH	ARM	FABRIC/LEATHER										FEATURES	DIMENSIONS	
					T01	A/COM	B	C	D	E	F	G	L3/COL	L4			L5
2160	Y1	MID-BACK SIMPLE SYNCHRO TILT CONTROL Use for a variety of general office seating, including private office and conference room seating.	M1	ARMLESS	475	500	530	550	580	615	655	695	625	695	750	<ul style="list-style-type: none"> • Pneumatic Seat Height Adjustment • Tilt Tension Control • Back and Seat Tilt in 3:1 Ratio • Upright Position Tilt Lock • Height Adjustable Lumbar • Ratchet Back • Rated for 250 lbs 	WIDTH: 26.5 DEPTH: 25.0 HEIGHT: 40.0-47.0 SEAT WIDTH: 21.0 SEAT DEPTH: 18.0 SEAT HEIGHT: 16.5-21.0 BACK WIDTH: 20.0 BACK HEIGHT: 23.0-25.0 COM: 0.8 YDS COL: 11.0 SQ FT WEIGHT: 42.0 LB
			M1	A10	560	585	615	635	665	700	740	780	710	780	835		
			M1	A36	580	605	635	655	685	720	760	800	730	800	855		
			M1	A37	600	625	655	675	705	740	780	820	750	820	875		
			M3	ARMLESS	500	525	555	575	605	640	680	720	650	720	775		
			M3	A10	585	610	640	660	690	725	765	805	735	805	860		
			M3	A36	605	630	660	680	710	745	785	825	755	825	880		
M3	A37	625	650	680	700	730	765	805	845	775	845	900					

SEAT SLIDER (SS) - ADD \$60

MODEL	CONTROL	DESCRIPTION	MESH	ARM	FABRIC/LEATHER										FEATURES	DIMENSIONS	
					T01	A/COM	B	C	D	E	F	G	L3/COL	L4			L5
2160	Y3	MID-BACK FULL SYNCHRO TILT CONTROL Use for a variety of general office seating, including private office and conference room seating.	M1	ARMLESS	545	570	600	620	650	685	725	765	695	765	820	<ul style="list-style-type: none"> • Pneumatic Seat Height Adjustment • Tilt Tension Control • Back and Seat Tilt in 2:1 ratio • 3 Locking Positions • Safety Tilt Release • Height Adjustable Lumbar • Ratchet Back • Rated for 300 lbs 	WIDTH: 26.5 DEPTH: 24.5 HEIGHT: 40.0-47.0 SEAT WIDTH: 21.0 SEAT DEPTH: 18.0 SEAT HEIGHT: 17.5-22.0 BACK WIDTH: 20.0 BACK HEIGHT: 22.0-25.0 COM: 0.8 YDS COL: 11.0 SQ FT WEIGHT: 43.5 LB
			M1	A10	630	655	685	705	735	770	810	850	780	850	905		
			M1	A36	650	675	705	725	755	790	830	870	800	870	925		
			M1	A37	670	695	725	745	775	810	850	890	820	890	945		
			M3	ARMLESS	570	595	625	645	675	710	750	790	720	790	845		
			M3	A10	655	680	710	730	760	795	835	875	805	875	930		
			M3	A36	675	700	730	750	780	815	855	895	825	895	950		
M3	A37	695	720	750	770	800	835	875	915	845	915	970					

SEAT SLIDER (SS) - ADD \$60

MODEL	CONTROL	DESCRIPTION	MESH	ARM	FABRIC/LEATHER										FEATURES	DIMENSIONS	
					T01	A/COM	B	C	D	E	F	G	L3/COL	L4			L5
2160	Y2	MID-BACK HEAVY DUTY SYNCHRO TILT CONTROL Use for a variety of general office seating, including private office and conference room seating.	M1	ARMLESS	595	620	650	670	700	735	775	815	745	815	870	<ul style="list-style-type: none"> • Pneumatic Seat Height Adjustment • Side Tilt Tension Control • Back and Seat Tilt in 2:1 ratio • 4 Locking Positions • Safety Tilt Release • Height Adjustable Lumbar • Ratchet Back • Rated for 300 lbs 	WIDTH: 26.5 DEPTH: 25.0 HEIGHT: 38.5-45.5 SEAT WIDTH: 21.0 SEAT DEPTH: 18.5 SEAT HEIGHT: 17.0-22.0 BACK WIDTH: 20.0 BACK HEIGHT: 21.5-23.5 COM: 0.8 YDS COL: 11.0 SQ FT WEIGHT: 45.5 LB
			M1	A10	680	705	735	755	785	820	860	900	830	900	955		
			M1	A36	700	725	755	775	805	840	880	920	850	920	975		
			M1	A37	720	745	775	795	825	860	900	940	870	940	995		
			M3	ARMLESS	620	645	675	695	725	760	800	840	770	840	895		
			M3	A10	705	730	760	780	810	845	885	925	855	925	980		
			M3	A36	725	750	780	800	830	865	905	945	875	945	1000		
M3	A37	745	770	800	820	850	885	925	965	895	965	1020					

SEAT SLIDER (SS) - ADD \$60

MODEL	CONTROL	DESCRIPTION	MESH	ARM	FABRIC/LEATHER										FEATURES	DIMENSIONS	
					T01	A/COM	B	C	D	E	F	G	L3/COL	L4			L5
2160	GT	GUEST MESH BACK - UPHOLSTERED SEAT Black steel cantilever frame.	M1	ARMLESS	350	375	405	425	455	490	530	570	500	570	625	<ul style="list-style-type: none"> • Black cantilever frame • Rated for 250 lbs 	WIDTH: 24.5 DEPTH: 24.5 HEIGHT: 40.5 SEAT WIDTH: 21.0 SEAT DEPTH: 18.0 SEAT HEIGHT: 21.5 BACK WIDTH: 20 BACK HEIGHT: 22 COM: 0.8 YDS COL: 11.0 SQ FT WEIGHT: 38.0 LB
			M1	A10	435	460	490	510	540	575	615	655	585	655	710		
			M3	ARMLESS	375	400	430	450	480	515	555	595	525	595	650		
			M3	A10	460	485	515	535	565	600	640	680	610	680	735		

ARM OPTIONS



A10
\$85

Black Soft Touch Cantilever style C-Shaped Arm



A36
\$105

8-Way Adjustable Arms Soft-Touch sliding and pivoting arm pads.



A37
\$125

10-Way Adjustable Arms Soft-Touch sliding and pivoting arm pads and 4" arm width knob under seat.

CASTER OPTIONS



C6
STD

Standard 60mm Hoodless Casters



C6S
\$35

60mm Hoodless Hard Floor Casters

ADDITIONAL OPTIONS



**BA10B
BA10P
BA10S**
\$100

26" High Profile Aluminum Base
BA10B - Black Powder-Coat
BA10P - Polished
BA10S - Silver Powder-Coat



SS
\$60

Seat Slider 2.5" Side Paddle Activated



HD
\$125

Heavy Duty Multi-Shift Upgrade to 350 lbs includes BA2B aluminum base and C4 60mm casters; available on Y2 configuration only

MESH COLORS

BLACK M11	GRAY M12	SILVER M13	GREEN M14	RED M15	BLUE M16
GRAPHITE M31	SLATE M32	SNOW M33	SAGE M34		
CARDINAL M35	ROYAL M36	TANGERINE M37	PLUM M38		

theory

the facts support theory as the smart choice

MESH BACK

GSA SIN # 711-18

- Task and conference seating
- Choice of 14 back mesh colors
- Warranted up to 250 lbs on Y1 and GT
- Warranted up to 300 lbs on Y2 and Y3
- Black nylon base
- Ratchet back adjustment with independent adjustable lumbar



CREATING THEORY MODEL NUMBER

MODEL NUMBER CONTROL ARMS BACK MESH COLOR CASTERS PACKAGING OPTIONS

2 1 8 0 - Y - A - M - C 6 - - - - -

* FOR ARMLESS CODE USE A00

PACKAGING NOTES

CODE	DESCRIPTION	LIST UPCHARGE
AB	ASSEMBLED IN BAG FOR WILL CALL	\$0
PAC	PARTIALLY ASSEMBLED IN CARTON	\$0
BAC	BACK ASSEMBLED IN CARTON	\$40

MODEL	CONTROL	DESCRIPTION	MESH	ARM	FABRIC/LEATHER	DIMENSIONS										
						T01	A/COM	B	C	D	E	F	G	L3/COL	L4	L5
2180	Y1	HIGH-BACK SIMPLE SYNCHRO TILT CONTROL	M1	ARMLESS		560	585	615	635	665	700	740	780	710	830	885
			M1	A10		645	670	700	720	750	785	825	865	795	915	970
			M1	A36		665	690	720	740	770	805	845	885	815	935	990
			M1	A37		685	710	740	760	790	825	865	905	835	955	1010
			M3	ARMLESS		585	610	640	660	690	725	765	805	735	855	910
			M3	A10		670	695	725	745	775	810	850	890	820	940	995
			M3	A36		690	715	745	765	795	830	870	910	840	960	1015
M3	A37		710	735	765	785	815	850	890	930	860	980	1035			

SEAT SLIDER (SS) - ADD \$60

- ### FEATURES
- Pneumatic Seat Height Adjustment
 - Tilt Tension Control
 - Back and Seat Tilt in 3:1 Ratio
 - Upright Position Tilt Lock
 - Height Adjustable Lumbar
 - Ratchet Back
 - Rated for 250 lbs

- ### DIMENSIONS
- WIDTH: 26.5
DEPTH: 25.0
HEIGHT: 40.0-47.0
SEAT WIDTH: 21.0
SEAT DEPTH: 18.0
SEAT HEIGHT: 16.5-21.0
BACK WIDTH: 20.0
BACK HEIGHT: 23.0-25.0
COM: 0.8 YDS
COL: 14.0 SQ FT
WEIGHT: 42.0 LB

ARM OPTIONS

A10
\$85

A36
\$105

A37
\$125

CASTER OPTIONS

C6
STD

C6S
\$35

ADDITIONAL OPTIONS

**BA10B
BA10P
BA10S**
\$100

SS
\$60

HD
\$125

MODEL	CONTROL	DESCRIPTION	MESH	ARM	FABRIC/LEATHER	DIMENSIONS										
						T01	A/COM	B	C	D	E	F	G	L3/COL	L4	L5
2180	Y3	MID-BACK FULL SYNCHRO TILT CONTROL	M1	ARMLESS		630	655	685	705	735	770	810	850	780	900	955
			M1	A10		715	740	770	790	820	855	895	935	865	985	1040
			M1	A36		735	760	790	810	840	875	915	955	885	1005	1060
			M1	A37		755	780	810	830	860	895	935	975	905	1025	1080
			M3	ARMLESS		655	680	710	730	760	795	835	875	805	925	980
			M3	A10		740	765	795	815	845	880	920	960	890	1010	1065
			M3	A36		760	785	815	835	865	900	940	980	910	1030	1085
M3	A37		780	805	835	855	885	920	960	1000	930	1050	1105			

SEAT SLIDER (SS) - ADD \$60

- ### FEATURES
- Pneumatic Seat Height Adjustment
 - Tilt Tension Control
 - Back and Seat Tilt in 2:1 ratio
 - 3 Locking Positions
 - Safety Tilt Release
 - Height Adjustable Lumbar
 - Ratchet Back
 - Rated for 300 lbs

- ### DIMENSIONS
- WIDTH: 26.5
DEPTH: 24.5
HEIGHT: 40.0-47.0
SEAT WIDTH: 21.0
SEAT DEPTH: 18.0
SEAT HEIGHT: 17.5-22.0
BACK WIDTH: 20.0
BACK HEIGHT: 22.0-25.0
COM: 0.8 YDS
COL: 14.0 SQ FT
WEIGHT: 43.5 LB

MODEL	CONTROL	DESCRIPTION	MESH	ARM	FABRIC/LEATHER	DIMENSIONS										
						T01	A/COM	B	C	D	E	F	G	L3/COL	L4	L5
2180	Y2	HIGH-BACK HEAVY DUTY SYNCHRO TILT CONTROL	M1	ARMLESS		680	705	735	755	785	820	860	900	830	950	1005
			M1	A10		765	790	820	840	870	905	945	985	915	1035	1090
			M1	A36		785	810	840	860	890	925	965	1005	935	1055	1110
			M1	A37		805	830	860	880	910	945	985	1025	955	1075	1130
			M3	ARMLESS		705	730	760	780	810	845	885	925	855	975	1030
			M3	A10		790	815	845	865	895	930	970	1010	940	1060	1115
			M3	A36		810	835	865	885	915	950	990	1030	960	1080	1135
M3	A37		830	855	885	905	935	970	1010	1050	980	1100	1155			

SEAT SLIDER (SS) - ADD \$60

- ### FEATURES
- Pneumatic Seat Height Adjustment
 - Side Tilt Tension Control
 - Back and Seat Tilt in 2:1 ratio
 - 4 Locking Positions
 - Safety Tilt Release
 - Height Adjustable Lumbar
 - Ratchet Back
 - Rated for 300 lbs

- ### DIMENSIONS
- WIDTH: 26.5
DEPTH: 25.0
HEIGHT: 45.5-54.0
SEAT WIDTH: 21.0
SEAT DEPTH: 18.0
SEAT HEIGHT: 17.0-22.0
BACK WIDTH: 20.0
BACK HEIGHT: 28.5-30.5
COM: 0.8 YDS
COL: 14.0 SQ FT
WEIGHT: 45.5 LB

MESH COLORS

BLACK M11	GRAY M12	SILVER M13	GREEN M14	RED M15	BLUE M16
GRAPHITE M31	SLATE M32	SNOW M33	SAGE M34		
CARDINAL M35	ROYAL M36	TANGERINE M37	PLUM M38		

theory

the facts support theory as the smart choice

GSA SIN # 711-18

- Task and conference seating
- Choice of 14 back mesh colors
- Warranted up to 250 lbs on Y1 and GT
- Warranted up to 300 lbs on Y2 and Y3
- Black nylon base
- Ratchet back adjustment with independent adjustable lumbar



CREATING THEORY MODEL NUMBER

MODEL NUMBER CONTROL ARMS BACK MESH COLOR GRADE CASTERS PACKAGING OPTIONS

2 1 6 - Y - A - M - C 6

* FOR ARMLESS CODE USE A00

PACKAGING NOTES

CODE	DESCRIPTION	LIST UPCHARGE
AB	ASSEMBLED IN BAG FOR WILL CALL	\$0
PAC	PARTIALLY ASSEMBLED IN CARTON	\$0
BAC	BACK ASSEMBLED IN CARTON	\$40

NEW MESH BACK STOOL

MODEL	CONTROL	DESCRIPTION	MESH	ARM	FABRIC/LEATHER	DIMENSIONS										
						T01	A/COM	B	C	D	E	F	G	L3/COL	L4	L5
NEW MODEL 2166	Y1	10" STOOL BASIC CONTROL Use for work surfaces up to 42 inches high.	M1	ARMLESS		600	625	655	675	705	740	780	820	750	870	925
			M1	A10		685	710	740	760	790	825	865	905	835	955	1010
			M1	A36		705	730	760	780	810	845	885	925	855	975	1030
			M1	A37		725	750	780	800	830	865	905	945	875	995	1050
			M3	ARMLESS		625	650	680	700	730	765	805	845	775	895	950
			M3	A10		710	735	765	785	815	850	890	930	860	980	1035
			M3	A36		730	755	785	805	835	870	910	950	880	1000	1055
			M3	A37		750	775	805	825	855	890	930	970	900	1020	1075

SEAT SLIDER (SS) - NOT AVAILABLE

MODEL	CONTROL	DESCRIPTION	MESH	ARM	FABRIC/LEATHER	DIMENSIONS										
						T01	A/COM	B	C	D	E	F	G	L3/COL	L4	L5
NEW MODEL 2168	Y1	8" STOOL BASIC CONTROL Use for work surfaces up to 36 inches high.	M1	ARMLESS		600	625	655	675	705	740	780	820	750	870	925
			M1	A10		685	710	740	760	790	825	865	905	835	955	1010
			M1	A36		705	730	760	780	810	845	885	925	855	975	1030
			M1	A37		725	750	780	800	830	865	905	945	875	995	1050
			M3	ARMLESS		625	650	680	700	730	765	805	845	775	895	950
			M3	A10		710	735	765	785	815	850	890	930	860	980	1035
			M3	A36		730	755	785	805	835	870	910	950	880	1000	1055
			M3	A37		750	775	805	825	855	890	930	970	900	1020	1075

SEAT SLIDER (SS) - NOT AVAILABLE

FEATURES

- Pneumatic Seat Height Adjustment
- Tilt Tension Control
- Back and Seat Tilt in 3:1 Ratio
- Upright Position Tilt Lock
- Height Adjustable Lumbar
- Ratchet Back
- Height Adjustable Footring
- Rated for 250 lbs

DIMENSIONS

WIDTH: 26.5
DEPTH: 26.5
HEIGHT: 47.75-60.50
SEAT WIDTH: 21.0
SEAT DEPTH: 18.0
SEAT HEIGHT: 26.5-36.5
BACK WIDTH: 20.3
BACK HEIGHT: 21.0-23.75
COM: 0.9 yd
COL: 11.0 sq ft
WEIGHT: 48.0

- Pneumatic Seat Height Adjustment
- Tilt Tension Control
- Back and Seat Tilt in 3:1 Ratio
- Upright Position Tilt Lock
- Height Adjustable Lumbar
- Ratchet Back
- Height Adjustable Footring
- Rated for 250 lbs

WIDTH: 26.5
DEPTH: 26.5
HEIGHT: 44.75-55.5
SEAT WIDTH: 21.0
SEAT DEPTH: 18.0
SEAT HEIGHT: 24-32
BACK WIDTH: 20.3
BACK HEIGHT: 21.0-23.75
COM: 0.9 yd
COL: 11.0 sq ft
WEIGHT: 48.0

ARM OPTIONS



A10
\$85

Black Soft Touch Cantilever style C-Shaped Arm



A36
\$105

8-Way Adjustable Arms Soft-Touch sliding and pivoting arm pads.



A37
\$125

10-Way Adjustable Arms Soft-Touch sliding and pivoting arm pads and 4" arm width knob under seat.

CASTER OPTIONS

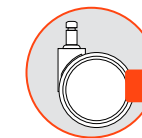

C6
STD

Standard 60mm Hoodless Casters

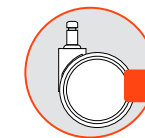

C6S
\$35

60mm Hoodless Hard Floor Casters

ADDITIONAL OPTIONS



BA10B
BA10P
BA10S
\$100

26" High Profile Aluminum Base
 BA10B - Black Powder-Coat
 BA10P - Polished
 BA10S - Silver Powder-Coat

MESH COLORS

BLACK M11	GRAY M12	SILVER M13	GREEN M14	RED M15	BLUE M16
GRAPHITE M31	SLATE M32	SNOW M33	SAGE M34		
CARDINAL M35	ROYAL M36	TANGERINE M37	PLUM M38		

theory

the facts support theory as the smart choice

ALL MESH

GSA SIN # 711-18

- Task and conference seating
- Choice of 14 back mesh colors
- Warranted up to 250 lbs on Y1 and GT
- Warranted up to 300 lbs on Y2 and Y3
- Black nylon base
- Ratchet back adjustment with independent adjustable lumbar



CREATING THEORY MODEL NUMBER

MODEL NUMBER	CONTROL	ARMS	BACK MESH COLOR	CASTERS	PACKAGING	OPTIONS
2170	-Y	-A	-M	-C6	-	-

* FOR ARMLESS CODE USE A00

PACKAGING NOTES

CODE	DESCRIPTION	LIST UPCHARGE
AB	ASSEMBLED IN BAG FOR WILL CALL	\$0
PAC	PARTIALLY ASSEMBLED IN CARTON	\$0
BAC	BACK ASSEMBLED IN CARTON	\$40

MODEL	CONTROL	DESCRIPTION	MESH	ARM	MESH
2170	Y1	MID-BACK SIMPLE SYNCHRO TILT CONTROL Use for a variety of general office seating, including private office and conference room seating.	M1	ARMLESS	M
			M1	A10	455
			M1	A36	540
			M1	A37	560
			M3	ARMLESS	580
			M3	A10	490
			M3	A36	575
			M3	A37	595
			M3	A37	615

SEAT SLIDER (SS) - ADD \$60 - FACTORY INSTALLED

MODEL	CONTROL	DESCRIPTION	MESH	ARM	MESH
2170	Y3	MID-BACK FULL SYNCHRO TILT CONTROL Use for a variety of general office seating, including private office and conference room seating.	M1	ARMLESS	M
			M1	A10	525
			M1	A36	610
			M1	A37	630
			M3	ARMLESS	650
			M3	A10	560
			M3	A36	645
			M3	A37	665
			M3	A37	685

SEAT SLIDER (SS) - ADD \$60 - FACTORY INSTALLED

MODEL	CONTROL	DESCRIPTION	MESH	ARM	MESH
2170	Y2	MID-BACK HEAVY DUTY SYNCHRO TILT CONTROL Use for a variety of general office seating, including private office and conference room seating.	M1	ARMLESS	M
			M1	A10	575
			M1	A36	660
			M1	A37	680
			M3	ARMLESS	700
			M3	A10	610
			M3	A36	695
			M3	A37	715
			M3	A37	735

SEAT SLIDER (SS) - ADD \$60 - FACTORY INSTALLED

FEATURES

- Pneumatic Seat Height Adjustment
- Tilt Tension Control
- Back and Seat Tilt in 3:1 Ratio
- Upright Position Tilt Lock
- Height Adjustable Lumbar
- Ratchet Back
- Rated for 250 lbs

DIMENSIONS

WIDTH: 26.5
DEPTH: 25.5
HEIGHT: 39.0-46.0
SEAT WIDTH: 20.0
SEAT DEPTH: 18.0
SEAT HEIGHT: 17.5-22.0
BACK WIDTH: 20.0
BACK HEIGHT: 23.0-26.0
COM: N/A
COL: N/A
WEIGHT: 40.5 LB

- Pneumatic Seat Height Adjustment
- Tilt Tension Control
- Back and Seat Tilt in 2:1 ratio
- 3 Locking Positions
- Safety Tilt Release
- Height Adjustable Lumbar
- Ratchet Back
- Rated for 300 lbs

WIDTH: 26.5
DEPTH: 26.0
HEIGHT: 38.0-45.0
SEAT WIDTH: 20.0
SEAT DEPTH: 18.0
SEAT HEIGHT: 17.0-21.5
BACK WIDTH: 20.0
BACK HEIGHT: 23.5-26.0
COM: N/A
COL: N/A
WEIGHT: 43.0 LB

- Pneumatic Seat Height Adjustment
- Side Tilt Tension Control
- Back and Seat Tilt in 2:1 ratio
- 4 Locking Positions
- Safety Tilt Release
- Height Adjustable Lumbar
- Ratchet Back
- Rated for 300 lbs

WIDTH: 26.5
DEPTH: 25.0
HEIGHT: 39.5-46.5
SEAT WIDTH: 20.0
SEAT DEPTH: 18.0
SEAT HEIGHT: 17.5-22.0
BACK WIDTH: 20.0
BACK HEIGHT: 23.0-25.5
COM: N/A
COL: N/A
WEIGHT: 45.0 LB

ARM OPTIONS



A10
\$85

Black Soft Touch Cantilever style C-Shaped Arm



A36
\$105

8-Way Adjustable Arms Soft-Touch sliding and pivoting arm pads.



A37
\$125

10-Way Adjustable Arms Soft-Touch sliding and pivoting arm pads and 4" arm width knob under seat.

CASTER OPTIONS

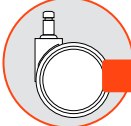

C6
STD

Standard 60mm Hoodless Casters

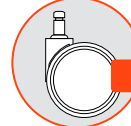

C6S
\$35

60mm Hoodless Hard Floor Casters

ADDITIONAL OPTIONS



BA10B
BA10P
BA10S
\$100

26" High Profile Aluminum Base
BA10B - Black Powder-Coat
BA10P - Polished
BA10S - Silver Powder-Coat



SS
\$60

Seat Slider 2.5" Side Paddle Activated



HD
\$125

Heavy Duty Multi-Shift Upgrade to 350 lbs includes BA2B aluminum base and C4 60mm casters; available on Y2 configuration only

MESH COLORS

BLACK M11	GRAY M12	SILVER M13	GREEN M14	RED M15	BLUE M16
GRAPHITE M31	SLATE M32	SNOW M33	SAGE M34		
CARDINAL M35	ROYAL M36	TANGERINE M37	PLUM M38		

theory

the facts support theory as the smart choice

ALL MESH

GSA SIN # 711-18

- Task and conference seating
- Choice of 14 back mesh colors
- Warranted up to 250 lbs on Y1
- Warranted up to 300 lbs on Y2 and Y3
- Black nylon base
- Ratchet back adjustment with independent adjustable lumbar



CREATING THEORY MODEL NUMBER

MODEL NUMBER CONTROL ARMS BACK MESH COLOR CASTERS PACKAGING OPTIONS

2 1 9 0 - Y 0 - 0 0 0 - M 0 0 - C 6 0 - 0 0 0 - 0 0 0

* FOR ARMLESS CODE USE A00

PACKAGING NOTES

CODE	DESCRIPTION	LIST UPCHARGE
AB	ASSEMBLED IN BAG FOR WILL CALL	\$0
PAC	PARTIALLY ASSEMBLED IN CARTON	\$0
BAC	BACK ASSEMBLED IN CARTON	\$40

MODEL	CONTROL	DESCRIPTION	MESH	ARM	MESH	FEATURES	DIMENSIONS		
2190	Y1	HIGH-BACK SIMPLE SYNCHRO TILT CONTROL Use for a variety of general office seating, including private office and conference room seating.	M1	ARMLESS	M	<ul style="list-style-type: none"> • Pneumatic Seat Height Adjustment • Tilt Tension Control • Back and Seat Tilt in 3:1 Ratio • Upright Position Tilt Lock • Height Adjustable Lumbar • Ratchet Back • Rated for 250 lbs 	WIDTH: 26.5 DEPTH: 25.5 HEIGHT: 44.5-55.0 SEAT WIDTH: 20.0 SEAT DEPTH: 18.0 SEAT HEIGHT: 17.5-21.0 BACK WIDTH: 20.0 BACK HEIGHT: 30.0-35.0 COM: N/A COL: N/A WEIGHT: 42.0 LB		
			M1	A10	625				
			M1	A36	645				
			M1	A37	665				
			M3	ARMLESS	575				
			M3	A10	660				
			M3	A36	680				
			M3	A37	700				
			SEAT SLIDER (SS) - ADD \$60 - FACTORY INSTALLED						
			2190	Y3	HIGH-BACK FULL SYNCHRO TILT CONTROL Use for a variety of general office seating, including private office and conference room seating.			M1	ARMLESS
M1	A10	695							
M1	A36	715							
M1	A37	735							
M3	ARMLESS	645							
M3	A10	730							
M3	A36	750							
M3	A37	770							
SEAT SLIDER (SS) - ADD \$60 - FACTORY INSTALLED									
2190	Y2	HIGH-BACK HEAVY DUTY SYNCHRO TILT CONTROL Use for a variety of general office seating, including private office and conference room seating.				M1	ARMLESS	M	<ul style="list-style-type: none"> • Pneumatic Seat Height Adjustment • Side Tilt Tension Control • Back and Seat Tilt in 2:1 ratio • 4 Locking Positions • Safety Tilt Release • Height Adjustable Lumbar • Ratchet Back • Rated for 300 lbs
			M1	A10	745				
			M1	A36	765				
			M1	A37	785				
			M3	ARMLESS	695				
			M3	A10	780				
			M3	A36	800				
			M3	A37	820				
			SEAT SLIDER (SS) - ADD \$60 - FACTORY INSTALLED						

ARM OPTIONS



A10
\$85

Black Soft Touch Cantilever style C-Shaped Arm



A36
\$105

8-Way Adjustable Arms Soft-Touch sliding and pivoting arm pads.



A37
\$125

10-Way Adjustable Arms Soft-Touch sliding and pivoting arm pads and 4" arm width knob under seat.

CASTER OPTIONS



C6
STD

Standard 60mm Hoodless Casters

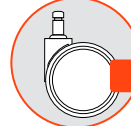

C6S
\$35

60mm Hoodless Hard Floor Casters

ADDITIONAL OPTIONS



BA10B
BA10P
BA10S
\$100

26" High Profile Aluminum Base
BA10B - Black Powder-Coat
BA10P - Polished
BA10S - Silver Powder-Coat



SS
\$60

Seat Slider 2.5" Side Paddle Activated



HD
\$125

Heavy Duty Multi-Shift Upgrade to 350 lbs includes BA2B aluminum base and C4 60mm casters; available on Y2 configuration only

MESH COLORS

BLACK M11	GRAY M12	SILVER M13	GREEN M14	RED M15	BLUE M16
GRAPHITE M31	SLATE M32	SNOW M33	SAGE M34	CARDINAL M35	ROYAL M36
TANGERINE M37	PLUM M38				

theory

the facts support theory as the smart choice

ALL MESH STOOL

GSA SIN # 711-18

- Task and conference seating
- Choice of 14 back mesh colors
- Warranted up to 250 lbs on Y1 and GT
- Warranted up to 300 lbs on Y2 and Y3
- Black nylon base
- Ratchet back adjustment with independent adjustable lumbar



CREATING THEORY MODEL NUMBER

MODEL NUMBER	CONTROL	ARMS	BACK MESH COLOR	CASTERS	PACKAGING	OPTIONS
217	Y	A	M	C6		

* FOR ARMLESS CODE USE ADD

PACKAGING NOTES

CODE	DESCRIPTION	LIST UPCHARGE
AB	ASSEMBLED IN BAG FOR WILL CALL	\$0
PAC	PARTIALLY ASSEMBLED IN CARTON	\$0
BAC	BACK ASSEMBLED IN CARTON	\$40

MODEL	CONTROL	DESCRIPTION	MESH	ARM	MESH	
NEW MODEL 2176	Y1	10" STOOL BASIC CONTROL Use for work surfaces up to 42 inches high.	M1	ARMLESS	M	
			M1	A10	580	
			M1	A36	665	
			M1	A37	685	
			M3	ARMLESS	705	
			M3	A10	605	
			M3	A36	690	
			M3	A37	710	
					730	
SEAT SLIDER (SS) - NOT AVAILABLE						

MODEL	CONTROL	DESCRIPTION	MESH	ARM	MESH	
NEW MODEL 2178	Y1	8" STOOL BASIC CONTROL Use for work surfaces up to 42 inches high.	M1	ARMLESS	M	
			M1	A10	580	
			M1	A36	665	
			M1	A37	685	
			M3	ARMLESS	705	
			M3	A10	605	
			M3	A36	690	
			M3	A37	710	
					730	
SEAT SLIDER (SS) - NOT AVAILABLE						

FEATURES

- Pneumatic Seat Height Adjustment
- Tilt Tension Control
- Back and Seat Tilt in 3:1 Ratio
- Upright Position Tilt Lock
- Height Adjustable Lumbar
- Ratchet Back
- Height Adjustable Footring
- Rated for 250 lbs

DIMENSIONS

WIDTH: 26.5
DEPTH: 26.5
HEIGHT: 47.25-60.5
SEAT WIDTH: 19.5
SEAT DEPTH: 18.0
SEAT HEIGHT: 26.0-36.0
BACK WIDTH: 20.0
BACK HEIGHT: 22.5-25.5
COM: NA
COL: NA
WEIGHT: 56.0 lbs

ARM OPTIONS

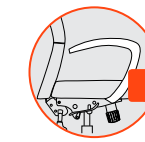

A10
\$85

Black Soft Touch Cantilever style C-Shaped Arm



A36
\$105

8-Way Adjustable Arms Soft-Touch sliding and pivoting arm pads.



A37
\$125

10-Way Adjustable Arms Soft-Touch sliding and pivoting arm pads and 4" arm width knob under seat.

CASTER OPTIONS

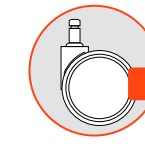

C6
STD

Standard 60mm Hoodless Casters

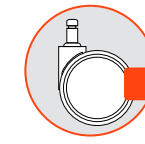

C6S
\$35

60mm Hoodless Hard Floor Casters

ADDITIONAL OPTIONS



BA10B
BA10P
BA10S
\$100

26" High Profile Aluminum Base
 BA10B - Black Powder-Coat
 BA10P - Polished
 BA10S - Silver Powder-Coat

MESH COLORS

BLACK M11	GRAY M12	SILVER M13	GREEN M14	RED M15	BLUE M16
GRAPHITE M31	SLATE M32	SNOW M33	SAGE M34	CARDINAL M35	ROYAL M36
TANGERINE M37	PLUM M38				

vault

goes beyond the expected

MESH BACK

GSA SIN # 711-18

- Task, stool, management and conference seating
- Ratchet back height adjustment standard
- Choice of 8 back mesh colors
- Seat slider standard on all models
- Warranted up to 250 lbs on Y1
- Warranted up to 300 lbs on Y3 and K2
- CAL TB 133 Fire Code approved



CREATING VAULT MODEL NUMBER

MODEL NUMBER	CONTROL	ARMS	BACK MESH COLOR	GRADE	CASTERS	PACKAGING	OPTIONS
1460		A	M2		C6		

* FOR ARMLESS CODE USE A00

PACKAGING NOTES

CODE	DESCRIPTION	LIST UPCHARGE
AB	ASSEMBLED IN BAG FOR WILL CALL	\$0
PAC	PARTIALLY ASSEMBLED IN CARTON	\$0
BAC	BACK ASSEMBLED IN CARTON	\$40

MODEL	CONTROL	DESCRIPTION	ARM	FABRIC/LEATHER											FEATURES	DIMENSIONS			
1460	Y1	RATCHET BACK SIMPLE SYNCHRO TILT CONTROL Use for a variety of general office task seating, including private office and conference room seating.	ARMLESS	T01	A/COM	B	C	D	E	F	G	L3/COL	L4	L5	<ul style="list-style-type: none"> • Pneumatic Seat Height Adjustment • Tilt Tension Control • Back and Seat Tilt in 3:1 Ratio • Upright Position Tilt Lock • Seat Slider Standard • Ratchet Back Height Lumbar Adjustment • Molded Foam Seat • Rated for 250 lbs 	WIDTH: 24.5-26.0 DEPTH: 25.0 HEIGHT: 39.5-46.5 SEAT WIDTH: 20.0 SEAT DEPTH: 16.0-18.5 SEAT HEIGHT: 17.5-22.0 BACK WIDTH: 18.5 BACK HEIGHT: 23.0-25.5 COM: 0.8 yds COL: 11.0 sq ft WEIGHT: 39.0 lb			
			A6	440	460	490	510	540	575	615	655	525	560	650					
			A7	570	590	620	640	670	705	745	785	655	690	780					
			A8	590	610	640	660	690	725	765	805	675	710	800					
			A9	525	545	575	595	625	660	700	740	610	645	735					
			A10	545	565	595	615	645	680	720	760	630	665	755					
			A36	525	545	575	595	625	660	700	740	610	645	735					
			A37	545	565	595	615	645	680	720	760	630	665	755					
			A40	565	585	615	635	665	700	740	780	650	685	775					
		A41	550	570	600	620	650	685	725	765	635	670	760						
			A41	570	590	620	640	670	705	745	785	655	690	780					

MODEL	CONTROL	DESCRIPTION	ARM	FABRIC/LEATHER											FEATURES	DIMENSIONS			
1460	Y3	RATCHET BACK FULL SYNCHRO TILT CONTROL Use for a variety of general office task seating, including private office and conference room seating.	ARMLESS	T01	A/COM	B	C	D	E	F	G	L3/COL	L4	L5	<ul style="list-style-type: none"> • Pneumatic Seat Height Adjustment • Tilt Tension Control • Back and Seat Tilt in 2:1 Ratio • 3 Locking Positions • Safety Tilt Release • Seat Slider Standard • Ratchet Back Height Lumbar Adjustment • Molded Foam Seat • Rated for 300 lbs 	WIDTH: 24.5-26.0 DEPTH: 25.0 HEIGHT: 39.5-46.5 SEAT WIDTH: 20.0 SEAT DEPTH: 16.0-18.5 SEAT HEIGHT: 17.5-22.0 BACK WIDTH: 18.5 BACK HEIGHT: 23.0-25.5 COM: 0.8 yds COL: 11.0 sq ft WEIGHT: 41.0 lb			
			A6	510	530	560	580	610	645	685	725	595	630	720					
			A7	640	660	690	710	740	775	815	855	725	760	850					
			A8	660	680	710	730	760	795	835	875	745	780	870					
			A9	595	615	645	665	695	730	770	810	680	715	805					
			A10	615	635	665	685	715	750	790	830	700	735	825					
			A36	595	615	645	665	695	730	770	810	680	715	805					
			A37	615	635	665	685	715	750	790	830	700	735	825					
			A40	635	655	685	705	735	770	810	850	720	755	845					
		A41	620	640	670	690	720	755	795	835	705	740	830						
			A41	640	660	690	710	740	775	815	855	725	760	850					

MODEL	CONTROL	DESCRIPTION	ARM	FABRIC/LEATHER											FEATURES	DIMENSIONS			
1460	K2	RATCHET BACK ENHANCED KNEE TILT CONTROL Ultimate seating comfort suited for the executive or manager. Allows for full range of movement with sharp, simple look.	ARMLESS	T01	A/COM	B	C	D	E	F	G	L3/COL	L4	L5	<ul style="list-style-type: none"> • Pneumatic Seat Height Adjustment • Side Activated Tilt Tension Control • Seat and Back Tilt as a unit • 3 Locking Positions • Reduced Rise of Front of Seat • Seat Slider Standard • Ratchet Back Height Lumbar Adjustment • Molded Foam Seat • Rated for 300 lbs 	WIDTH: 24.5-26.0 DEPTH: 25.0 HEIGHT: 39.5-46.5 SEAT WIDTH: 20.0 SEAT DEPTH: 16.0-18.5 SEAT HEIGHT: 17.5-22.0 BACK WIDTH: 18.5 BACK HEIGHT: 23.0-25.5 COM: 0.8 yds COL: 11.0 sq ft WEIGHT: 41.0 lb			
			A6	530	550	580	600	630	665	705	745	615	650	740					
			A7	660	680	710	730	760	795	835	875	745	780	870					
			A8	680	700	730	750	780	815	855	895	765	800	890					
			A9	615	635	665	685	715	750	790	830	700	735	825					
			A10	635	655	685	705	735	770	810	850	720	755	845					
			A36	615	635	665	685	715	750	790	830	700	735	825					
			A37	635	655	685	705	735	770	810	850	720	755	845					
			A40	655	675	705	725	755	790	830	870	740	775	865					
		A41	640	660	690	710	740	775	815	855	725	760	850						
			A41	660	680	710	730	760	795	835	875	745	780	870					

ARM OPTIONS

A6 \$130

A7 \$150

6-way A6 or 8-way A7 Adjustable Am for height, pivots, and with *Ura-Soft* sliding arm pads

A8B/S \$85

A9B/S \$105

A8 2-Way Height Adjustable Arm, A9 4-Way Adjustable Height Adjustable with 4" Interior Width Adjustment
A8B -Black, A8S -Silver
A9B -Black, A9S -Silver

A10 \$85

Black Soft Touch Cantilever style C-Shaped Arm

A36 \$105

A37 \$125

A36, 8-Way Adjustable Soft-Touch sliding and pivoting arm with pads, A37, 10-Way Adjustable with 4" arm width knob under seat.

A40 \$110

A41 \$130

A40 2-Way or 6-way A41 Adjustable Arm Ratchet Height Adjustment with Fixed Arm Pad

CASTER OPTIONS

C6 STD

Standard 60mm Hoodless Casters

C6S \$35

60mm Hoodless Hard Floor Casters

ADDITIONAL OPTIONS

BA10B \$100

BA10P

BA10S

26" High Profile Aluminum Base
BA10B - Black Powder-Coat
BA10P - Polished
BA10S - Silver Powder-Coat

EF1 \$30

Extra Foam 1" on Seat
Not Available with Leather

MF1 \$50

1" Visco Elastic Memory Foam on Seat
Not Available with Leather

MESH COLORS

BLACK M21	GRAY M22	WHITE M23	GREEN M24
RED M25	BLUE M26	ORANGE M27	AQUA M28

vault

goes beyond the expected

MESH BACK

GSA SIN # 711-18

- Task, stool, management and conference seating
- Ratchet back height adjustment standard
- Choice of 8 back mesh colors
- Seat slider standard on all models
- Warranted up to 250 lbs on Y1
- Warranted up to 300 lbs on Y3 and K2
- CAL TB 133 Fire Code approved



CREATING VAULT MODEL NUMBER

MODEL NUMBER CONTROL ARMS BACK MESH COLOR GRADE CASTERS PACKAGING OPTIONS

1 4 8 0 - [] [] - A [] [] - M 2 [] [] - [] [] - C 6 [] [] - [] [] [] []

* FOR ARMLESS CODE USE A00

PACKAGING NOTES

CODE	DESCRIPTION	LIST UPCHARGE
AB	ASSEMBLED IN BAG FOR WILL CALL	\$0
PAC	PARTIALLY ASSEMBLED IN CARTON	\$0
BAC	BACK ASSEMBLED IN CARTON	\$40

MODEL	CONTROL	DESCRIPTION	ARM	FABRIC/LEATHER	DIMENSIONS										FEATURES	DIMENSIONS	
					T01	A/COM	B	C	D	E	F	G	L3/COL	L4			L5
1480	Y1	RATCHET BACK WITH HEADREST SIMPLE SYNCHRO TILT CONTROL Use for a variety of general office task seating, including private office and conference room seating.	ARMLESS		515	535	565	585	615	650	690	730	600	635	725	<ul style="list-style-type: none"> • Pneumatic Seat Height Adjustment • Tilt Tension Control • Back and Seat Tilt in 3:1 Ratio • Upright Position Tilt Lock • Seat Slider Standard • Ratchet Back Height Lumbar Adjustment • Molded Foam Seat • Rated for 250 lbs 	WIDTH: 24.5-26.0 DEPTH: 25.0 HEIGHT: 39.5-46.5 SEAT WIDTH: 20.0 SEAT DEPTH: 16.0-18.5 SEAT HEIGHT: 17.5-22.0 BACK WIDTH: 18.5 BACK HEIGHT: 23.0-25.5 COM: 0.8 yds COL: 11.0 sq ft WEIGHT: 39.0 lb
			A6	645	665	695	715	745	780	820	860	730	765	855			
			A7	665	685	715	735	765	800	840	880	750	785	875			
			A8	600	620	650	670	700	735	775	815	685	720	810			
			A9	620	640	670	690	720	755	795	835	705	740	830			
			A10	600	620	650	670	700	735	775	815	685	720	810			
			A36	620	640	670	690	720	755	795	835	705	740	830			
			A37	640	660	690	710	740	775	815	855	725	760	850			
			A40	625	645	675	695	725	760	800	840	710	745	835			
			A41	645	665	695	715	745	780	820	860	730	765	855			
1480	Y3	RATCHET BACK WITH HEADREST FULL SYNCHRO TILT CONTROL Use for a variety of general office task seating, including private office and conference room seating.	ARMLESS		585	605	635	655	685	720	760	800	670	705	795	<ul style="list-style-type: none"> • Pneumatic Seat Height Adjustment • Tilt Tension Control • Back and Seat Tilt in 2:1 Ratio • 3 Locking Positions • Safety Tilt Release • Seat Slider Standard • Ratchet Back Height Lumbar Adjustment • Molded Foam Seat • Rated for 300 lbs 	WIDTH: 24.5-26.0 DEPTH: 25.0 HEIGHT: 39.5-46.5 SEAT WIDTH: 20.0 SEAT DEPTH: 16.0-18.5 SEAT HEIGHT: 17.5-22.0 BACK WIDTH: 18.5 BACK HEIGHT: 23.0-25.5 COM: 0.8 yds COL: 11.0 sq ft WEIGHT: 41.0 lb
			A6	715	735	765	785	815	850	890	930	800	835	925			
			A7	735	755	785	805	835	870	910	950	820	855	945			
			A8	670	690	720	740	770	805	845	885	755	790	880			
			A9	690	710	740	760	790	825	865	905	775	810	900			
			A10	670	690	720	740	770	805	845	885	755	790	880			
			A36	690	710	740	760	790	825	865	905	775	810	900			
			A37	710	730	760	780	810	845	885	925	795	830	920			
			A40	695	715	745	765	795	830	870	910	780	815	905			
			A41	715	735	765	785	815	850	890	930	800	835	925			
1480	K2	RATCHET BACK WITH HEADREST ENHANCED KNEE TILT CONTROL Ultimate seating comfort suited for the executive or manager. Allows for full range of movement with sharp, simple look.	ARMLESS		605	625	655	675	705	740	780	820	690	725	815	<ul style="list-style-type: none"> • Pneumatic Seat Height Adjustment • Side Activated Tilt Tension Control • Seat and Back Tilt as a unit • 3 Locking Positions • Reduced Rise of Front of Seat • Seat Slider Standard • Ratchet Back Height Lumbar Adjustment • Molded Foam Seat • Rated for 300 lbs 	WIDTH: 24.5-26.0 DEPTH: 25.0 HEIGHT: 39.5-46.5 SEAT WIDTH: 20.0 SEAT DEPTH: 16.0-18.5 SEAT HEIGHT: 17.5-22.0 BACK WIDTH: 18.5 BACK HEIGHT: 23.0-25.5 COM: 0.8 yds COL: 11.0 sq ft WEIGHT: 41.0 lb
			A6	735	755	785	805	835	870	910	950	820	855	945			
			A7	755	775	805	825	855	890	930	970	840	875	965			
			A8	690	710	740	760	790	825	865	905	775	810	900			
			A9	710	730	760	780	810	845	885	925	795	830	920			
			A10	690	710	740	760	790	825	865	905	775	810	900			
			A36	710	730	760	780	810	845	885	925	795	830	920			
			A37	730	750	780	800	830	865	905	945	815	850	940			
			A40	715	735	765	785	815	850	890	930	800	835	925			
			A41	735	755	785	805	835	870	910	950	820	855	945			

ARM OPTIONS



A6
\$130



A8B/S
\$85



A10
\$85

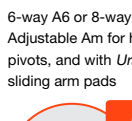

A7
\$150

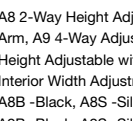

A9B/S
\$105



A36
\$105

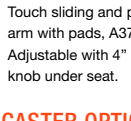

A37
\$125



A40
\$110

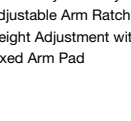

A41
\$130

CASTER OPTIONS

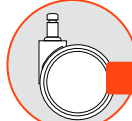

C6
STD



C6S
\$35

Standard 60mm Hoodless Casters | 60mm Hoodless Hard Floor Casters

ADDITIONAL OPTIONS



BA10B
BA10P
BA10S
\$100



EF1
\$30



MF1
\$50

26" High Profile Aluminum Base BA10B - Black Powder-Coat BA10P - Polished BA10S - Silver Powder-Coat | Extra Foam 1" on Seat Not Available with Leather | 1" Visco Elastic Memory Foam on Seat Not Available with Leather

MESH COLORS

BLACK M21	GRAY M22	WHITE M23	GREEN M24
RED M25	BLUE M26	ORANGE M27	AQUA M28

vault

goes beyond the expected

MESH BACK STOOL

GSA SIN # 711-18

- Task, stool, management and conference seating
- Ratchet back height adjustment standard
- Choice of 8 back mesh colors
- Seat slider standard on all models
- Warranted up to 250 lbs on all models
- CAL TB 133 Fire Code approved



CREATING VAULT MODEL NUMBER

MODEL NUMBER CONTROL ARMS BACK MESH COLOR GRADE CASTERS PACKAGING OPTIONS

1 4 6 0 - - A - - M 2 - - C 6 - - - -

* FOR ARMLESS CODE USE A00

PACKAGING NOTES

CODE	DESCRIPTION	LIST UPCHARGE
AB	ASSEMBLED IN BAG FOR WILL CALL	\$0
PAC	PARTIALLY ASSEMBLED IN CARTON	\$0
BAC	BACK ASSEMBLED IN CARTON	\$40

MODEL	CONTROL	DESCRIPTION	ARM	FABRIC/LEATHER											FEATURES	DIMENSIONS	ARM OPTIONS	CASTER OPTIONS	ADDITIONAL OPTIONS	MESH COLORS																		
				T01	A/COM	B	C	D	E	F	G	L3/COL	L4	L5																								
1466 	Y1 	10" TRAVEL HIGH STOOL SIMPLE SYNCHRO TILT CONTROL Use for work surfaces up to 42 inches high.	ARMLESS	565	585	615	635	665	700	740	780	650	685	775	<ul style="list-style-type: none"> • Pneumatic Seat Height Adjustment • Tilt Tension Control • Back and Seat Tilt in 3:1 Ratio • Upright Position Tilt Lock • Seat Slider Standard • Ratchet Back Height Lumbar Adjustment • Molded Foam Seat • Height Adj 20" Diameter Footring • Rated for 250 lbs 	<p>WIDTH: 24.5-26.0</p> <p>DEPTH: 25.0</p> <p>HEIGHT: 49.0-62.5</p> <p>SEAT WIDTH: 20.0</p> <p>SEAT DEPTH: 16.0-18.5</p> <p>SEAT HEIGHT: 27.0-37.0</p> <p>BACK WIDTH: 18.5</p> <p>BACK HEIGHT: 23.0-25.5</p> <p>COM: 0.8 yds</p> <p>COL: 11.0 sq ft</p> <p>WEIGHT: 45.0 lb</p>	<p>A6 \$130</p> <p>A7 \$150</p> <p>A8B/S \$85</p> <p>A9B/S \$105</p> <p>A10 \$85</p> <p>A36 \$105</p> <p>A37 \$125</p> <p>A40 \$110</p> <p>A41 \$130</p>	<p>C6 STD</p> <p>C6S \$35</p>	<p>BA10B \$100</p> <p>BA10P</p> <p>BA10S</p> <p>EF1 \$30</p> <p>MF1 \$50</p>	<table border="1"> <tr> <td>BLACK M21</td> <td>GRAY M22</td> <td>WHITE M23</td> <td>GREEN M24</td> </tr> <tr> <td>RED M25</td> <td>BLUE M26</td> <td>ORANGE M27</td> <td>AQUA M28</td> </tr> </table>	BLACK M21	GRAY M22	WHITE M23	GREEN M24	RED M25	BLUE M26	ORANGE M27	AQUA M28										
			BLACK M21	GRAY M22	WHITE M23	GREEN M24																																
			RED M25	BLUE M26	ORANGE M27	AQUA M28																																
			A6	695	715	745	765	795	830	870	910	780	815	905							<ul style="list-style-type: none"> • Pneumatic Seat Height Adjustment • Tilt Tension Control • Back and Seat Tilt in 3:1 Ratio • Upright Position Tilt Lock • Seat Slider Standard • Ratchet Back Height Lumbar Adjustment • Molded Foam Seat • Height Adj 20" Diameter Footring • Rated for 250 lbs 	<p>WIDTH: 24.5-26.0</p> <p>DEPTH: 25.0</p> <p>HEIGHT: 45.0-55.5</p> <p>SEAT WIDTH: 20.0</p> <p>SEAT DEPTH: 16.0-18.5</p> <p>SEAT HEIGHT: 22.0-30.0</p> <p>BACK WIDTH: 18.5</p> <p>BACK HEIGHT: 23.0-25.5</p> <p>COM: 0.8 yds</p> <p>COL: 11.0 sq ft</p> <p>WEIGHT: 44.0 lb</p>	<p>C6 STD</p> <p>C6S \$35</p>	<p>BA10B \$100</p> <p>BA10P</p> <p>BA10S</p> <p>EF1 \$30</p> <p>MF1 \$50</p>	<table border="1"> <tr> <td>BLACK M21</td> <td>GRAY M22</td> <td>WHITE M23</td> <td>GREEN M24</td> </tr> <tr> <td>RED M25</td> <td>BLUE M26</td> <td>ORANGE M27</td> <td>AQUA M28</td> </tr> </table>	BLACK M21	GRAY M22	WHITE M23	GREEN M24	RED M25	BLUE M26	ORANGE M27	AQUA M28					
			BLACK M21	GRAY M22	WHITE M23	GREEN M24																																
			RED M25	BLUE M26	ORANGE M27	AQUA M28																																
			A7	715	735	765	785	815	850	890	930	800	835	925												<ul style="list-style-type: none"> • Pneumatic Seat Height Adjustment • Tilt Tension Control • Back and Seat Tilt in 3:1 Ratio • Upright Position Tilt Lock • Seat Slider Standard • Ratchet Back Height Lumbar Adjustment • Molded Foam Seat • Height Adj 20" Diameter Footring • Rated for 250 lbs 	<p>WIDTH: 24.5-26.0</p> <p>DEPTH: 25.0</p> <p>HEIGHT: 45.0-55.5</p> <p>SEAT WIDTH: 20.0</p> <p>SEAT DEPTH: 16.0-18.5</p> <p>SEAT HEIGHT: 22.0-30.0</p> <p>BACK WIDTH: 18.5</p> <p>BACK HEIGHT: 23.0-25.5</p> <p>COM: 0.8 yds</p> <p>COL: 11.0 sq ft</p> <p>WEIGHT: 44.0 lb</p>	<p>C6 STD</p> <p>C6S \$35</p>	<p>BA10B \$100</p> <p>BA10P</p> <p>BA10S</p> <p>EF1 \$30</p> <p>MF1 \$50</p>	<table border="1"> <tr> <td>BLACK M21</td> <td>GRAY M22</td> <td>WHITE M23</td> <td>GREEN M24</td> </tr> <tr> <td>RED M25</td> <td>BLUE M26</td> <td>ORANGE M27</td> <td>AQUA M28</td> </tr> </table>	BLACK M21	GRAY M22	WHITE M23	GREEN M24	RED M25	BLUE M26	ORANGE M27	AQUA M28
			BLACK M21	GRAY M22	WHITE M23	GREEN M24																																
			RED M25	BLUE M26	ORANGE M27	AQUA M28																																
			A8	650	670	700	720	750	785	825	865	735	770	860																	<ul style="list-style-type: none"> • Pneumatic Seat Height Adjustment • Tilt Tension Control • Back and Seat Tilt in 3:1 Ratio • Upright Position Tilt Lock • Seat Slider Standard • Ratchet Back Height Lumbar Adjustment • Molded Foam Seat • Height Adj 20" Diameter Footring • Rated for 250 lbs 	<p>WIDTH: 24.5-26.0</p> <p>DEPTH: 25.0</p> <p>HEIGHT: 45.0-55.5</p> <p>SEAT WIDTH: 20.0</p> <p>SEAT DEPTH: 16.0-18.5</p> <p>SEAT HEIGHT: 22.0-30.0</p> <p>BACK WIDTH: 18.5</p> <p>BACK HEIGHT: 23.0-25.5</p> <p>COM: 0.8 yds</p> <p>COL: 11.0 sq ft</p> <p>WEIGHT: 44.0 lb</p>	<p>C6 STD</p> <p>C6S \$35</p>	<p>BA10B \$100</p> <p>BA10P</p> <p>BA10S</p> <p>EF1 \$30</p> <p>MF1 \$50</p>	<table border="1"> <tr> <td>BLACK M21</td> <td>GRAY M22</td> <td>WHITE M23</td> <td>GREEN M24</td> </tr> <tr> <td>RED M25</td> <td>BLUE M26</td> <td>ORANGE M27</td> <td>AQUA M28</td> </tr> </table>	BLACK M21	GRAY M22	WHITE M23
BLACK M21	GRAY M22	WHITE M23	GREEN M24																																			
RED M25	BLUE M26	ORANGE M27	AQUA M28																																			
A9	670	690	720	740	770	805	845	885	755	790	880	<ul style="list-style-type: none"> • Pneumatic Seat Height Adjustment • Tilt Tension Control • Back and Seat Tilt in 3:1 Ratio • Upright Position Tilt Lock • Seat Slider Standard • Ratchet Back Height Lumbar Adjustment • Molded Foam Seat • Height Adj 20" Diameter Footring • Rated for 250 lbs 	<p>WIDTH: 24.5-26.0</p> <p>DEPTH: 25.0</p> <p>HEIGHT: 45.0-55.5</p> <p>SEAT WIDTH: 20.0</p> <p>SEAT DEPTH: 16.0-18.5</p> <p>SEAT HEIGHT: 22.0-30.0</p> <p>BACK WIDTH: 18.5</p> <p>BACK HEIGHT: 23.0-25.5</p> <p>COM: 0.8 yds</p> <p>COL: 11.0 sq ft</p> <p>WEIGHT: 44.0 lb</p>	<p>C6 STD</p> <p>C6S \$35</p>	<p>BA10B \$100</p> <p>BA10P</p> <p>BA10S</p> <p>EF1 \$30</p> <p>MF1 \$50</p>	<table border="1"> <tr> <td>BLACK M21</td> <td>GRAY M22</td> <td>WHITE M23</td> <td>GREEN M24</td> </tr> <tr> <td>RED M25</td> <td>BLUE M26</td> <td>ORANGE M27</td> <td>AQUA M28</td> </tr> </table>	BLACK M21	GRAY M22	WHITE M23	GREEN M24																RED M25	BLUE M26	ORANGE M27
BLACK M21	GRAY M22	WHITE M23	GREEN M24																																			
RED M25	BLUE M26	ORANGE M27	AQUA M28																																			
A10	650	670	700	720	750	785	825	865	735	770	860						<ul style="list-style-type: none"> • Pneumatic Seat Height Adjustment • Tilt Tension Control • Back and Seat Tilt in 3:1 Ratio • Upright Position Tilt Lock • Seat Slider Standard • Ratchet Back Height Lumbar Adjustment • Molded Foam Seat • Height Adj 20" Diameter Footring • Rated for 250 lbs 	<p>WIDTH: 24.5-26.0</p> <p>DEPTH: 25.0</p> <p>HEIGHT: 45.0-55.5</p> <p>SEAT WIDTH: 20.0</p> <p>SEAT DEPTH: 16.0-18.5</p> <p>SEAT HEIGHT: 22.0-30.0</p> <p>BACK WIDTH: 18.5</p> <p>BACK HEIGHT: 23.0-25.5</p> <p>COM: 0.8 yds</p> <p>COL: 11.0 sq ft</p> <p>WEIGHT: 44.0 lb</p>	<p>C6 STD</p> <p>C6S \$35</p>	<p>BA10B \$100</p> <p>BA10P</p> <p>BA10S</p> <p>EF1 \$30</p> <p>MF1 \$50</p>	<table border="1"> <tr> <td>BLACK M21</td> <td>GRAY M22</td> <td>WHITE M23</td> <td>GREEN M24</td> </tr> <tr> <td>RED M25</td> <td>BLUE M26</td> <td>ORANGE M27</td> <td>AQUA M28</td> </tr> </table>	BLACK M21	GRAY M22	WHITE M23	GREEN M24											RED M25	BLUE M26	ORANGE M27
BLACK M21	GRAY M22	WHITE M23	GREEN M24																																			
RED M25	BLUE M26	ORANGE M27	AQUA M28																																			
A36	670	690	720	740	770	805	845	885	755	790	880											<ul style="list-style-type: none"> • Pneumatic Seat Height Adjustment • Tilt Tension Control • Back and Seat Tilt in 3:1 Ratio • Upright Position Tilt Lock • Seat Slider Standard • Ratchet Back Height Lumbar Adjustment • Molded Foam Seat • Height Adj 20" Diameter Footring • Rated for 250 lbs 	<p>WIDTH: 24.5-26.0</p> <p>DEPTH: 25.0</p> <p>HEIGHT: 45.0-55.5</p> <p>SEAT WIDTH: 20.0</p> <p>SEAT DEPTH: 16.0-18.5</p> <p>SEAT HEIGHT: 22.0-30.0</p> <p>BACK WIDTH: 18.5</p> <p>BACK HEIGHT: 23.0-25.5</p> <p>COM: 0.8 yds</p> <p>COL: 11.0 sq ft</p> <p>WEIGHT: 44.0 lb</p>	<p>C6 STD</p> <p>C6S \$35</p>	<p>BA10B \$100</p> <p>BA10P</p> <p>BA10S</p> <p>EF1 \$30</p> <p>MF1 \$50</p>	<table border="1"> <tr> <td>BLACK M21</td> <td>GRAY M22</td> <td>WHITE M23</td> <td>GREEN M24</td> </tr> <tr> <td>RED M25</td> <td>BLUE M26</td> <td>ORANGE M27</td> <td>AQUA M28</td> </tr> </table>	BLACK M21	GRAY M22	WHITE M23	GREEN M24						RED M25	BLUE M26	ORANGE M27
BLACK M21	GRAY M22	WHITE M23	GREEN M24																																			
RED M25	BLUE M26	ORANGE M27	AQUA M28																																			
A37	690	710	740	760	790	825	865	905	775	810	900																<ul style="list-style-type: none"> • Pneumatic Seat Height Adjustment • Tilt Tension Control • Back and Seat Tilt in 3:1 Ratio • Upright Position Tilt Lock • Seat Slider Standard • Ratchet Back Height Lumbar Adjustment • Molded Foam Seat • Height Adj 20" Diameter Footring • Rated for 250 lbs 	<p>WIDTH: 24.5-26.0</p> <p>DEPTH: 25.0</p> <p>HEIGHT: 45.0-55.5</p> <p>SEAT WIDTH: 20.0</p> <p>SEAT DEPTH: 16.0-18.5</p> <p>SEAT HEIGHT: 22.0-30.0</p> <p>BACK WIDTH: 18.5</p> <p>BACK HEIGHT: 23.0-25.5</p> <p>COM: 0.8 yds</p> <p>COL: 11.0 sq ft</p> <p>WEIGHT: 44.0 lb</p>	<p>C6 STD</p> <p>C6S \$35</p>	<p>BA10B \$100</p> <p>BA10P</p> <p>BA10S</p> <p>EF1 \$30</p> <p>MF1 \$50</p>	<table border="1"> <tr> <td>BLACK M21</td> <td>GRAY M22</td> <td>WHITE M23</td> <td>GREEN M24</td> </tr> <tr> <td>RED M25</td> <td>BLUE M26</td> <td>ORANGE M27</td> <td>AQUA M28</td> </tr> </table>	BLACK M21	GRAY M22	WHITE M23	GREEN M24	RED M25	BLUE M26	ORANGE M27
BLACK M21	GRAY M22	WHITE M23	GREEN M24																																			
RED M25	BLUE M26	ORANGE M27	AQUA M28																																			
A40	675	695	725	745	775	810	850	890	760	795	885	<ul style="list-style-type: none"> • Pneumatic Seat Height Adjustment • Tilt Tension Control • Back and Seat Tilt in 3:1 Ratio • Upright Position Tilt Lock • Seat Slider Standard • Ratchet Back Height Lumbar Adjustment • Molded Foam Seat • Height Adj 20" Diameter Footring • Rated for 250 lbs 	<p>WIDTH: 24.5-26.0</p> <p>DEPTH: 25.0</p> <p>HEIGHT: 45.0-55.5</p> <p>SEAT WIDTH: 20.0</p> <p>SEAT DEPTH: 16.0-18.5</p> <p>SEAT HEIGHT: 22.0-30.0</p> <p>BACK WIDTH: 18.5</p> <p>BACK HEIGHT: 23.0-25.5</p> <p>COM: 0.8 yds</p> <p>COL: 11.0 sq ft</p> <p>WEIGHT: 44.0 lb</p>	<p>C6 STD</p> <p>C6S \$35</p>	<p>BA10B \$100</p> <p>BA10P</p> <p>BA10S</p> <p>EF1 \$30</p> <p>MF1 \$50</p>	<table border="1"> <tr> <td>BLACK M21</td> <td>GRAY M22</td> <td>WHITE M23</td> <td>GREEN M24</td> </tr> <tr> <td>RED M25</td> <td>BLUE M26</td> <td>ORANGE M27</td> <td>AQUA M28</td> </tr> </table>																BLACK M21	GRAY M22	WHITE M23	GREEN M24	RED M25	BLUE M26	ORANGE M27
BLACK M21	GRAY M22	WHITE M23	GREEN M24																																			
RED M25	BLUE M26	ORANGE M27	AQUA M28																																			
A41	695	715	745	765	795	830	870	910	780	815	905						<ul style="list-style-type: none"> • Pneumatic Seat Height Adjustment • Tilt Tension Control • Back and Seat Tilt in 3:1 Ratio • Upright Position Tilt Lock • Seat Slider Standard • Ratchet Back Height Lumbar Adjustment • Molded Foam Seat • Height Adj 20" Diameter Footring • Rated for 250 lbs 	<p>WIDTH: 24.5-26.0</p> <p>DEPTH: 25.0</p> <p>HEIGHT: 45.0-55.5</p> <p>SEAT WIDTH: 20.0</p> <p>SEAT DEPTH: 16.0-18.5</p> <p>SEAT HEIGHT: 22.0-30.0</p> <p>BACK WIDTH: 18.5</p> <p>BACK HEIGHT: 23.0-25.5</p> <p>COM: 0.8 yds</p> <p>COL: 11.0 sq ft</p> <p>WEIGHT: 44.0 lb</p>	<p>C6 STD</p> <p>C6S \$35</p>	<p>BA10B \$100</p> <p>BA10P</p> <p>BA10S</p> <p>EF1 \$30</p> <p>MF1 \$50</p>	<table border="1"> <tr> <td>BLACK M21</td> <td>GRAY M22</td> <td>WHITE M23</td> <td>GREEN M24</td> </tr> <tr> <td>RED M25</td> <td>BLUE M26</td> <td>ORANGE M27</td> <td>AQUA M28</td> </tr> </table>											BLACK M21	GRAY M22	WHITE M23	GREEN M24	RED M25	BLUE M26	ORANGE M27
BLACK M21	GRAY M22	WHITE M23	GREEN M24																																			
RED M25	BLUE M26	ORANGE M27	AQUA M28																																			

vesta

excellence in total ergonomics

ALL MESH

GSA SIN # 711-18

- Task, task stool, executive and conference seating
- Seat styles include: mesh and upholstered
- Choice of 3 frame colors and 6 mesh colors
- Aluminum base standard
- Warranted up to 250 lbs with stool
- Warranted up to 300 lbs with X1 except for stool
- CAL TB 133 Fire Code approved



CREATING VESTA MODEL NUMBER

MODEL NUMBER	CONTROL	ARMS	FRAME COLOR	MESH COLOR	GRADE	CASTERS	PACKAGING	OPTIONS
30	X1	A		M		C8S		

* FOR ARMLESS CODE USE A0 * CHROME FRAME COLOR (CF) IS NO LONGER AVAILABLE AND HAS BEEN REPLACED WITH POLISHED ALUMINUM (PF)

FRAME COLORS

CODE	DESCRIPTION
BF	BLACK
PF	POLISHED
SF	SILVER

PACKAGING NOTES

CODE	DESCRIPTION	LIST UPCHARGE
AB	ASSEMBLED IN BAG FOR WILL CALL	\$0
BAC	BACK ASSEMBLED IN CARTON	\$0

MODEL	CONTROL	DESCRIPTION	ARM	MESH	FEATURES	DIMENSIONS	ARM OPTIONS	CASTER OPTIONS	MESH COLORS								
3060	X1	MID-BACK DYNAMIC SYNCHRO TILT CONTROL Use for a variety of general office task seating, including private office and conference room seating.	<table border="1"> <tr><td>ARMLESS</td><td>975</td></tr> <tr><td>A28</td><td>1075</td></tr> <tr><td>A29</td><td>1075</td></tr> <tr><td>A30</td><td>1100</td></tr> </table>	ARMLESS	975	A28	1075	A29	1075	A30	1100	M	<ul style="list-style-type: none"> • Pneumatic Seat Height Adjustment • Side Adjustable Tilt Tension Control • Back and Seat Tilt in 2.6:1 Ratio • 26° Tilt of Back, 10° Seat Tilt • 11 Locking Positions • 2 Position Forward Seat Angle Adj • Standard Seat Slider Adds 2.5" Adj • Standard with Heavy Duty Hard Floor Casters • Rated for 300 lbs 	WIDTH: 24.5-26.5 DEPTH: 25.0 HEIGHT: 41.0-45.5 SEAT WIDTH: 19.5 SEAT DEPTH: 17.0-18.5 SEAT HEIGHT: 17.0-21.5 BACK WIDTH: 19.5 BACK HEIGHT: 23.5 WEIGHT: 54.0 LB			
ARMLESS	975																
A28	1075																
A29	1075																
A30	1100																
3080	X1	HIGH-BACK DYNAMIC SYNCHRO TILT CONTROL Use for a variety of general office task seating, including private office and conference room seating.	<table border="1"> <tr><td>ARMLESS</td><td>1100</td></tr> <tr><td>A28</td><td>1200</td></tr> <tr><td>A29</td><td>1200</td></tr> <tr><td>A30</td><td>1225</td></tr> </table>	ARMLESS	1100	A28	1200	A29	1200	A30	1225	M	<ul style="list-style-type: none"> • Pneumatic Seat Height Adjustment • Side Adjustable Tilt Tension Control • Back and Seat Tilt in 2.6:1 Ratio • 26° Tilt of Back, 10° Seat Tilt • 11 Locking Positions • 2 Position Forward Seat Angle Adj • Standard Seat Slider Adds 2" Adj • Standard with Heavy Duty Hard Floor Casters • 3 Way Adjustable Headrest • Rated for 300 lbs 	WIDTH: 24.5-26.5 DEPTH: 25.0 HEIGHT: 50.0-54.5 SEAT WIDTH: 19.5 SEAT DEPTH: 17.0-18.5 SEAT HEIGHT: 17.0-21.5 BACK WIDTH: 19.5 BACK HEIGHT: 23.5 WEIGHT: 56.0 LB			
ARMLESS	1100																
A28	1200																
A29	1200																
A30	1225																
3061	X1	10" TRAVEL HIGH STOOL DYNAMIC SYNCHRO TILT CONTROL Use for work surfaces up to 42 inches high.	<table border="1"> <tr><td>ARMLESS</td><td>1100</td></tr> <tr><td>A28</td><td>1200</td></tr> <tr><td>A29</td><td>1200</td></tr> <tr><td>A30</td><td>1225</td></tr> </table>	ARMLESS	1100	A28	1200	A29	1200	A30	1225	M	<ul style="list-style-type: none"> • Pneumatic Seat Height Adjustment • Side Adjustable Tilt Tension Control • Back and Seat Tilt in 2.6:1 Ratio • 26° Tilt of Back, 10° Seat Tilt • 11 Locking Positions • 2 Position Forward Seat Angle Adj • Standard Seat Slider Adds 2.5" Adj • Standard with Heavy Duty Hard Floor Casters • Height Adj 20" Diameter Footring • Rated for 250 lbs 	WIDTH: 24.5-26.5 DEPTH: 25.0 HEIGHT: 50.5-60.5 SEAT WIDTH: 19.5 SEAT DEPTH: 17.0-18.5 SEAT HEIGHT: 26.0-36.0 BACK WIDTH: 19.5 BACK HEIGHT: 23.5 WEIGHT: 60.0 LB			
ARMLESS	1100																
A28	1200																
A29	1200																
A30	1225																
3063	X1	8" TRAVEL LOW STOOL DYNAMIC SYNCHRO TILT CONTROL Use for work surfaces up to 36 inches high.	<table border="1"> <tr><td>ARMLESS</td><td>1100</td></tr> <tr><td>A28</td><td>1200</td></tr> <tr><td>A29</td><td>1200</td></tr> <tr><td>A30</td><td>1225</td></tr> </table>	ARMLESS	1100	A28	1200	A29	1200	A30	1225	M	<ul style="list-style-type: none"> • Pneumatic Seat Height Adjustment • Side Adjustable Tilt Tension Control • Back and Seat Tilt in 2.6:1 Ratio • 26° Tilt of Back, 10° Seat Tilt • 11 Locking Positions • 2 Position Forward Seat Angle Adj • Standard Seat Slider Adds 2.5" Adj • Standard with Heavy Duty Hard Floor Casters • Height Adj 20" Diameter Footring • Rated for 250 lbs 	WIDTH: 24.5-26.5 DEPTH: 25.0 HEIGHT: 46.5-54.5 SEAT WIDTH: 19.5 SEAT DEPTH: 17.0-18.5 SEAT HEIGHT: 22.0-30.0 BACK WIDTH: 19.5 BACK HEIGHT: 23.5 WEIGHT: 59.0 LB			
ARMLESS	1100																
A28	1200																
A29	1200																
A30	1225																

vesta

excellence in total ergonomics

MESH BACK

GSA SIN # 711-18

- Task, task stool, executive and conference seating
- Seat styles include: mesh and upholstered
- Choice of 3 frame colors and 6 mesh colors
- Aluminum base standard
- Warranted up to 250 lbs with stool
- Warranted up to 300 lbs with X1 except for stool
- CAL TB 133 Fire Code approved



CREATING VESTA MODEL NUMBER

MODEL NUMBER CONTROL ARMS FRAME COLOR MESH COLOR GRADE CASTERS PACKAGING OPTIONS

3 0 - X 1 - A - M - C 8 S -

* FOR ARMLESS CODE USE A00 * CHROME FRAME COLOR (CF) IS NO LONGER AVAILABLE AND HAS BEEN REPLACED WITH POLISHED ALUMINUM (PF)

FRAME COLORS

CODE	DESCRIPTION
BF	BLACK
PF	POLISHED
SF	SILVER

PACKAGING NOTES

CODE	DESCRIPTION	LIST UPCHARGE
AB	ASSEMBLED IN BAG FOR WILL CALL	\$0
BAC	BACK ASSEMBLED IN CARTON	\$0

MODEL	CONTROL	DESCRIPTION	ARM	FABRIC/LEATHER	FEATURES	DIMENSIONS	ARM OPTIONS	CASTER OPTIONS	MESH COLORS																																																		
3065	X1	MID-BACK DYNAMIC SYNCHRO TILT CONTROL Use for a variety of general office task seating, including private office and conference room seating.	ARMLESS A28 A29 A30	<table border="1"> <thead> <tr> <th>A/COM</th> <th>B</th> <th>C</th> <th>D</th> <th>E</th> <th>F</th> <th>G</th> <th>L3/COL</th> <th>L4</th> <th>L5</th> </tr> </thead> <tbody> <tr> <td>1050</td> <td>1085</td> <td>1110</td> <td>1145</td> <td>1185</td> <td>1230</td> <td>1280</td> <td>1095</td> <td>1150</td> <td>1190</td> </tr> <tr> <td>1150</td> <td>1185</td> <td>1210</td> <td>1245</td> <td>1285</td> <td>1330</td> <td>1380</td> <td>1195</td> <td>1250</td> <td>1290</td> </tr> <tr> <td>1150</td> <td>1185</td> <td>1210</td> <td>1245</td> <td>1285</td> <td>1330</td> <td>1380</td> <td>1195</td> <td>1250</td> <td>1290</td> </tr> <tr> <td>1175</td> <td>1210</td> <td>1235</td> <td>1270</td> <td>1310</td> <td>1355</td> <td>1405</td> <td>1220</td> <td>1275</td> <td>1315</td> </tr> </tbody> </table>	A/COM	B	C	D	E	F	G	L3/COL	L4	L5	1050	1085	1110	1145	1185	1230	1280	1095	1150	1190	1150	1185	1210	1245	1285	1330	1380	1195	1250	1290	1150	1185	1210	1245	1285	1330	1380	1195	1250	1290	1175	1210	1235	1270	1310	1355	1405	1220	1275	1315	<ul style="list-style-type: none"> • Pneumatic Seat Height Adjustment • Side Adjustable Tilt Tension Control • Back and Seat Tilt in 2.6:1 Ratio • 26° Tilt of Back, 10° Seat Tilt • 11 Locking Positions • 2 Position Forward Seat Angle Adj • Standard Seat Slider Adds 2.5" Adj • Standard with Heavy Duty Hard Floor Casters • Rated for 300 lbs 	<p>WIDTH: 24.5-26.5 DEPTH: 25.0 HEIGHT: 41.0-45.5</p> <p>SEAT WIDTH: 19.5 SEAT DEPTH: 17.0-18.5 SEAT HEIGHT: 17.0-21.5 BACK WIDTH: 19.5 BACK HEIGHT: 23.5 COM: 1.1 YDS WEIGHT: 54.0 LB</p>	<p>A28 \$100 2-Way Adjustable Arm Height Adjustable w/ 19" Interior Width</p> <p>A29 \$100 2-Way Adjustable Arm Height Adjustable w/ 17.5" Interior Width</p> <p>A30 \$125 6-Way Adjustable Arm Height, Width, and Forward Slide Adjustment</p>	<p>C8S STD Standard 75mm Hoodless Casters for use on low to medium pile carpet or hard surfaces</p>	
A/COM	B	C	D	E	F	G	L3/COL	L4	L5																																																		
1050	1085	1110	1145	1185	1230	1280	1095	1150	1190																																																		
1150	1185	1210	1245	1285	1330	1380	1195	1250	1290																																																		
1150	1185	1210	1245	1285	1330	1380	1195	1250	1290																																																		
1175	1210	1235	1270	1310	1355	1405	1220	1275	1315																																																		
3085	X1	HIGH-BACK DYNAMIC SYNCHRO TILT CONTROL Use for a variety of general office task seating, including private office and conference room seating.	ARMLESS A28 A29 A30	<table border="1"> <thead> <tr> <th>A/COM</th> <th>B</th> <th>C</th> <th>D</th> <th>E</th> <th>F</th> <th>G</th> <th>L3/COL</th> <th>L4</th> <th>L5</th> </tr> </thead> <tbody> <tr> <td>1175</td> <td>1210</td> <td>1235</td> <td>1270</td> <td>1310</td> <td>1355</td> <td>1405</td> <td>1220</td> <td>1275</td> <td>1315</td> </tr> <tr> <td>1275</td> <td>1310</td> <td>1335</td> <td>1370</td> <td>1410</td> <td>1455</td> <td>1505</td> <td>1320</td> <td>1375</td> <td>1415</td> </tr> <tr> <td>1275</td> <td>1310</td> <td>1335</td> <td>1370</td> <td>1410</td> <td>1455</td> <td>1505</td> <td>1320</td> <td>1375</td> <td>1415</td> </tr> <tr> <td>1300</td> <td>1335</td> <td>1360</td> <td>1395</td> <td>1435</td> <td>1480</td> <td>1530</td> <td>1345</td> <td>1400</td> <td>1440</td> </tr> </tbody> </table>	A/COM	B	C	D	E	F	G	L3/COL	L4	L5	1175	1210	1235	1270	1310	1355	1405	1220	1275	1315	1275	1310	1335	1370	1410	1455	1505	1320	1375	1415	1275	1310	1335	1370	1410	1455	1505	1320	1375	1415	1300	1335	1360	1395	1435	1480	1530	1345	1400	1440	<ul style="list-style-type: none"> • Pneumatic Seat Height Adjustment • Side Adjustable Tilt Tension Control • Back and Seat Tilt in 2.6:1 Ratio • 26° Tilt of Back, 10° Seat Tilt • 11 Locking Positions • 2 Position Forward Seat Angle Adj • Standard Seat Slider Adds 2" Adj • Standard with Heavy Duty Hard Floor Casters • 3 Way Adjustable Headrest • Rated for 300 lbs 	<p>WIDTH: 24.5-26.5 DEPTH: 25.0 HEIGHT: 50.0-54.5</p> <p>SEAT WIDTH: 19.5 SEAT DEPTH: 17.0-18.5 SEAT HEIGHT: 17.0-21.5 BACK WIDTH: 19.5 BACK HEIGHT: 23.5 COM: 1.1 YDS WEIGHT: 56.0 LB</p>	<p>C8S STD Standard 75mm Hoodless Casters for use on low to medium pile carpet or hard surfaces</p>		
A/COM	B	C	D	E	F	G	L3/COL	L4	L5																																																		
1175	1210	1235	1270	1310	1355	1405	1220	1275	1315																																																		
1275	1310	1335	1370	1410	1455	1505	1320	1375	1415																																																		
1275	1310	1335	1370	1410	1455	1505	1320	1375	1415																																																		
1300	1335	1360	1395	1435	1480	1530	1345	1400	1440																																																		
3066	X1	10" TRAVEL HIGH STOOL DYNAMIC SYNCHRO TILT CONTROL Use for work surfaces up to 42 inches high.	ARMLESS A28 A29 A30	<table border="1"> <thead> <tr> <th>A/COM</th> <th>B</th> <th>C</th> <th>D</th> <th>E</th> <th>F</th> <th>G</th> <th>L3/COL</th> <th>L4</th> <th>L5</th> </tr> </thead> <tbody> <tr> <td>1175</td> <td>1210</td> <td>1235</td> <td>1270</td> <td>1310</td> <td>1355</td> <td>1405</td> <td>1220</td> <td>1275</td> <td>1315</td> </tr> <tr> <td>1275</td> <td>1310</td> <td>1335</td> <td>1370</td> <td>1410</td> <td>1455</td> <td>1505</td> <td>1320</td> <td>1375</td> <td>1415</td> </tr> <tr> <td>1275</td> <td>1310</td> <td>1335</td> <td>1370</td> <td>1410</td> <td>1455</td> <td>1505</td> <td>1320</td> <td>1375</td> <td>1415</td> </tr> <tr> <td>1300</td> <td>1335</td> <td>1360</td> <td>1395</td> <td>1435</td> <td>1480</td> <td>1530</td> <td>1345</td> <td>1400</td> <td>1440</td> </tr> </tbody> </table>	A/COM	B	C	D	E	F	G	L3/COL	L4	L5	1175	1210	1235	1270	1310	1355	1405	1220	1275	1315	1275	1310	1335	1370	1410	1455	1505	1320	1375	1415	1275	1310	1335	1370	1410	1455	1505	1320	1375	1415	1300	1335	1360	1395	1435	1480	1530	1345	1400	1440	<ul style="list-style-type: none"> • Pneumatic Seat Height Adjustment • Side Adjustable Tilt Tension Control • Back and Seat Tilt in 2.6:1 Ratio • 26° Tilt of Back, 10° Seat Tilt • 11 Locking Positions • 2 Position Forward Seat Angle Adj • Standard Seat Slider Adds 2.5" Adj • Standard with Heavy Duty Hard Floor Casters • Height Adj 20" Diameter Footring • Rated for 250 lbs 	<p>WIDTH: 24.5-26.5 DEPTH: 25.0 HEIGHT: 50.5-60.5</p> <p>SEAT WIDTH: 19.5 SEAT DEPTH: 17.0-18.5 SEAT HEIGHT: 26.0-36.0 BACK WIDTH: 19.5 BACK HEIGHT: 23.5 COM: 1.1 YDS WEIGHT: 60.0 LB</p>			
A/COM	B	C	D	E	F	G	L3/COL	L4	L5																																																		
1175	1210	1235	1270	1310	1355	1405	1220	1275	1315																																																		
1275	1310	1335	1370	1410	1455	1505	1320	1375	1415																																																		
1275	1310	1335	1370	1410	1455	1505	1320	1375	1415																																																		
1300	1335	1360	1395	1435	1480	1530	1345	1400	1440																																																		
3068	X1	8" TRAVEL LOW STOOL DYNAMIC SYNCHRO TILT CONTROL Use for work surfaces up to 36 inches high.	ARMLESS A28 A29 A30	<table border="1"> <thead> <tr> <th>A/COM</th> <th>B</th> <th>C</th> <th>D</th> <th>E</th> <th>F</th> <th>G</th> <th>L3/COL</th> <th>L4</th> <th>L5</th> </tr> </thead> <tbody> <tr> <td>1175</td> <td>1210</td> <td>1235</td> <td>1270</td> <td>1310</td> <td>1355</td> <td>1405</td> <td>1220</td> <td>1275</td> <td>1315</td> </tr> <tr> <td>1275</td> <td>1310</td> <td>1335</td> <td>1370</td> <td>1410</td> <td>1455</td> <td>1505</td> <td>1320</td> <td>1375</td> <td>1415</td> </tr> <tr> <td>1275</td> <td>1310</td> <td>1335</td> <td>1370</td> <td>1410</td> <td>1455</td> <td>1505</td> <td>1320</td> <td>1375</td> <td>1415</td> </tr> <tr> <td>1300</td> <td>1335</td> <td>1360</td> <td>1395</td> <td>1435</td> <td>1480</td> <td>1530</td> <td>1345</td> <td>1400</td> <td>1440</td> </tr> </tbody> </table>	A/COM	B	C	D	E	F	G	L3/COL	L4	L5	1175	1210	1235	1270	1310	1355	1405	1220	1275	1315	1275	1310	1335	1370	1410	1455	1505	1320	1375	1415	1275	1310	1335	1370	1410	1455	1505	1320	1375	1415	1300	1335	1360	1395	1435	1480	1530	1345	1400	1440	<ul style="list-style-type: none"> • Pneumatic Seat Height Adjustment • Side Adjustable Tilt Tension Control • Back and Seat Tilt in 2.6:1 Ratio • 26° Tilt of Back, 10° Seat Tilt • 11 Locking Positions • 2 Position Forward Seat Angle Adj • Standard Seat Slider Adds 2.5" Adj • Standard with Heavy Duty Hard Floor Casters • Height Adj 20" Diameter Footring • Rated for 250 lbs 	<p>WIDTH: 24.5-26.5 DEPTH: 25.0 HEIGHT: 46.5-54.5</p> <p>SEAT WIDTH: 19.5 SEAT DEPTH: 17.0-18.5 SEAT HEIGHT: 22.0-30.0 BACK WIDTH: 19.5 BACK HEIGHT: 23.5 COM: 1.1 YDS WEIGHT: 59.0 LB</p>			
A/COM	B	C	D	E	F	G	L3/COL	L4	L5																																																		
1175	1210	1235	1270	1310	1355	1405	1220	1275	1315																																																		
1275	1310	1335	1370	1410	1455	1505	1320	1375	1415																																																		
1275	1310	1335	1370	1410	1455	1505	1320	1375	1415																																																		
1300	1335	1360	1395	1435	1480	1530	1345	1400	1440																																																		

zoom

Rapid setup for a crew or a crowd

GSA SIN # 711-18 Pending

- The ultimate in collaborative seating
- Compact nesting style
- Mesh back
- Torsion spring flex back with back lock
- Upholstered seat option
- Warranted up to 250 lbs



CREATING ZOOM MODEL NUMBER

MODEL NUMBER CONTROL FRAME COLOR PLASTIC COLOR UPHOLSTERY GRADE CASTERS PACKAGING

1 1 1 5 - G T - S F - P A - - D - C 1 2 - A B

* FOR ARMLESS CODE USE A00 * ONLY SELECT CASTER CODE FOR MODEL 1215,1265

FRAME COLORS

CODE	DESCRIPTION
SF	SILVER
WF	WHITE

PACKAGING NOTES

CODE	DESCRIPTION	LIST UPCHARGE
AB	ASSEMBLED IN BAG FOR WILL CALL	\$0
AC	ASSEMBLED IN CARTON	\$0

ZOOM NESTING CHAIRS SHIP UP TO 2 PER CARTON

NEW MESH BACK - AP/US

MODEL	CONTROL	DESCRIPTION	FRAME COLOR	PLASTIC	FEATURES	DIMENSIONS
NEW MODEL 1115	GT	GUEST NESTING PLASTIC SEAT Mesh back with plastic seat.	SF WF	P 395 395	<ul style="list-style-type: none"> • Flexible back • Locking back • Upright lock position • Rated up to 250 lbs 	WIDTH: 24 DEPTH: 22 HEIGHT: 33.5 SEAT WIDTH: 18 SEAT DEPTH: 16.5 SEAT HEIGHT: 17.5 BACK WIDTH: 19 BACK HEIGHT: 17 COM: 1 YD WEIGHT: 22 LB

CASTER OPTIONS

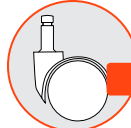

C12
STD

Standard
50mm Hooded
Casters

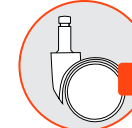

C5S
\$30

50mm Hooded
Hard Floor Casters

MODEL	CONTROL	DESCRIPTION	FRAME COLOR	PLASTIC	FEATURES	DIMENSIONS
NEW MODEL 1115	GT	GUEST NESTING UPHOLSTERED SEAT Mesh back with upholstered seat.	SF WF	A/COM B C D E F G 460 495 515 550 585 625 670 460 495 515 550 585 625 670	<ul style="list-style-type: none"> • Flexible back • Locking back • Upright lock position • Rated up to 250 lbs 	WIDTH: 26 DEPTH: 22 HEIGHT: 33.5 SEAT WIDTH: 18 SEAT DEPTH: 16.5 SEAT HEIGHT: 17.5 BACK WIDTH: 19 BACK HEIGHT: 17 COM: 14 YD WEIGHT: 22 LB



First Chair 25", Each Additional Chair, Add 8"

CAUTION: Careless nesting of chairs may scratch and damage frames.

PLASTIC COLORS

GRAY PGA	ONLY AVAILABLE WITH M32 MESH
WHITE PWA	ONLY AVAILABLE WITH M33 MESH

AVAILABLE APRIL 2017

zoom

Rapid setup for a crew or a crowd

GSA SIN # 711-18 Pending

- Training, task, multipurpose, stool, management and conference seating
- Choice of plastic or upholstered seat
- 2 powder coated frame finishes
- Warranted up to 250 lbs



CREATING ZOOM MODEL NUMBER

MODEL NUMBER CONTROL FRAME COLOR PLASTIC COLOR UPHOLSTERY GRADE CASTERS PACKAGING

1 1 1 5 - B 2 - F - P A - - - C 1 2 - - -

* FOR ARMLESS CODE USE A00 * ONLY SELECT CASTER CODE FOR MODEL 1215,1265

FRAME COLORS

CODE	DESCRIPTION
SF	SILVER
WF	WHITE

PACKAGING NOTES

CODE	DESCRIPTION	LIST UPCHARGE
AB	ASSEMBLED IN BAG FOR WILL CALL	\$0
AC	ASSEMBLED IN CARTON	\$0

ZOOM NESTING CHAIRS SHIP UP TO 2 PER CARTON

NEW TASK CHAIR AP

MODEL	CONTROL	DESCRIPTION	FRAME COLOR	PLASTIC	DIMENSIONS							FEATURES
NEW MODEL 1125	B2	LOW-BACK BASIC CONTROL Mesh back with plastic seat.	SF	A/COM 495	B	C	D	E	F	G	<ul style="list-style-type: none"> • Pneumatic Seat Height Adjustment • Flexible back • Rated up to 250 lbs 	
	WF		495									

MODEL	CONTROL	DESCRIPTION	FRAME COLOR	PLASTIC	DIMENSIONS							FEATURES
NEW MODEL 1126	B2	10" TRAVEL HIGH STOOL BASIC CONTROL Mesh back with plastic seat.	SF	A/COM 620	B	C	D	E	F	G	<ul style="list-style-type: none"> • Pneumatic Seat Height Adjustment • Height Adj 20" Diameter Footring • Flexible back • Rated up to 250 lbs 	
	WF		620									

MODEL	CONTROL	DESCRIPTION	FRAME COLOR	PLASTIC	DIMENSIONS							FEATURES
NEW MODEL 1128	B2	8" TRAVEL LOW STOOL BASIC CONTROL Mesh back with plastic seat.	SF	A/COM 620	B	C	D	E	F	G	<ul style="list-style-type: none"> • Pneumatic Seat Height Adjustment • Height Adj 20" Diameter Footring • Flexible back • Rated up to 250 lbs 	
	WF		620									

DIMENSIONS	
WIDTH:	26.0
DEPTH:	25.0
HEIGHT:	33.5-38
SEAT WIDTH:	18
SEAT DEPTH:	16.5
SEAT HEIGHT:	17.5-22
BACK WIDTH:	19
BACK HEIGHT:	17
COM:	1.0 YD
WEIGHT:	28 LB

DIMENSIONS	
WIDTH:	26.0
DEPTH:	25.0
HEIGHT:	41-51
SEAT WIDTH:	18
SEAT DEPTH:	16.5
SEAT HEIGHT:	25-35
BACK WIDTH:	19
BACK HEIGHT:	17
COM:	1.0 YD
WEIGHT:	30 LB

DIMENSIONS	
WIDTH:	26.0
DEPTH:	25.0
HEIGHT:	37-45
SEAT WIDTH:	18
SEAT DEPTH:	16.5
SEAT HEIGHT:	21-29
BACK WIDTH:	19
BACK HEIGHT:	17
COM:	1.0 YD
WEIGHT:	29.5 LB

CASTER OPTIONS

	C6 STD	Standard 60mm Hoodless Casters
	C6S \$35	60mm Hoodless Hard Floor Casters

BASE OPTIONS

	BA9 STD	26" High Profile Black Nylon Base comes standard w/ C6 65mm Hoodless Casters
	BA10B BA10P BA10S \$100	26" High Profile Aluminum Base BA10B - Black Powder-Coat BA10P - Polished BA10S - Silver Powder-Coat

PLASTIC COLORS

GRAY PGA	ONLY AVAILABLE WITH M32 MESH
WHITE PWA	ONLY AVAILABLE WITH M33 MESH

AVAILABLE APRIL 2017

zoom

Rapid setup for a crew or a crowd

GSA SIN # 711-18 Pending

- Training, task, multipurpose, stool, management and conference seating
- Choice of plastic or upholstered seat
- 2 powder coated frame finishes
- Warranted up to 250 lbs



CREATING ZOOM MODEL NUMBER

MODEL NUMBER CONTROL FRAME COLOR PLASTIC COLOR UPHOLSTERY GRADE CASTERS PACKAGING

1 1 1 5 - B 2 - F - P A - - - C 1 2 - - -

* FOR ARMLESS CODE USE A00 * ONLY SELECT CASTER CODE FOR MODEL 1215,1265

FRAME COLORS

CODE	DESCRIPTION
SF	SILVER
WF	WHITE

PACKAGING NOTES

CODE	DESCRIPTION	LIST UPCHARGE
AB	ASSEMBLED IN BAG FOR WILL CALL	\$0
AC	ASSEMBLED IN CARTON	\$0

ZOOM NESTING CHAIRS SHIP UP TO 2 PER CARTON

NEW TASK CHAIR UPHOLSTERED SEAT US

MODEL	CONTROL	DESCRIPTION	FRAME COLOR	PLASTIC	A/COM	B	C	D	E	F	G
NEW MODEL 1125	B2	LOW-BACK BASIC CONTROL Mesh back with upholstered seat.	SF		560	595	615	650	685	725	770
			WF		560	595	615	650	685	725	770

- ### FEATURES
- Pneumatic Seat Height Adjustment
 - Flexible back
 - Rated up to 250 lbs

DIMENSIONS

WIDTH: 26.0
DEPTH: 25.0
HEIGHT: 33.5-38
SEAT WIDTH: 18
SEAT DEPTH: 16.5
SEAT HEIGHT: 17.5-22
BACK WIDTH: 19
BACK HEIGHT: 17
COM: 1.0 YD
WEIGHT: 28 LB

CASTER OPTIONS

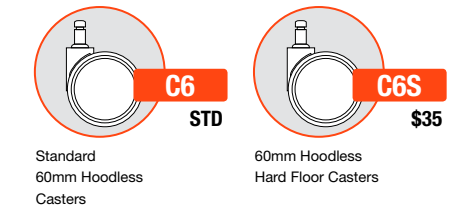

MODEL	CONTROL	DESCRIPTION	FRAME COLOR	PLASTIC	A/COM	B	C	D	E	F	G
NEW MODEL 1126	B2	10" TRAVEL HIGH STOOL BASIC CONTROL Mesh back with upholstered seat.	SF		685	720	740	775	810	850	895
			WF		685	720	740	775	810	850	895

- Pneumatic Seat Height Adjustment
- Height Adj 20" Diameter Footring
- Flexible back
- Rated up to 250 lbs

DIMENSIONS

WIDTH: 26.0
DEPTH: 25.0
HEIGHT: 41-51
SEAT WIDTH: 18
SEAT DEPTH: 16.5
SEAT HEIGHT: 25-35
BACK WIDTH: 19
BACK HEIGHT: 17
COM: 1.0 YD
WEIGHT: 30 LB

BASE OPTIONS

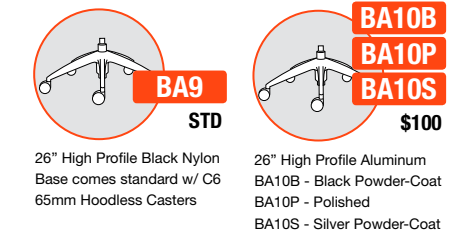

MODEL	CONTROL	DESCRIPTION	FRAME COLOR	PLASTIC	A/COM	B	C	D	E	F	G
NEW MODEL 1128	B	8" TRAVEL LOW STOOL BASIC CONTROL Mesh back with upholstered seat.	SF		685	720	740	775	810	850	895
			WF		685	720	740	775	810	850	895

- Pneumatic Seat Height Adjustment
- Height Adj 20" Diameter Footring
- Flexible back
- Rated up to 250 lbs

DIMENSIONS

WIDTH: 26.0
DEPTH: 25.0
HEIGHT: 37-45
SEAT WIDTH: 18
SEAT DEPTH: 16.5
SEAT HEIGHT: 21-29
BACK WIDTH: 19
BACK HEIGHT: 17
COM: 1.0 YD
WEIGHT: 29.5 LB

PLASTIC COLORS

GRAY PGA	ONLY AVAILABLE WITH M32 MESH
WHITE PWA	ONLY AVAILABLE WITH M33 MESH

AVAILABLE APRIL 2017

NEW SIT IN STYLE. WORK IN COMFORT. GET THE VALUE.

PACKAGING NOTES

CODE	DESCRIPTION	LIST UPCHARGE
	SHIPS IN BOX ONLY	
	SOME ITEMS SHIP PARTIALLY ASSEMBLED	
	**SPLIT CARTON FEE APPLIES	\$25 NET

MODEL	FEATURES	DIMENSIONS	ARM	TEXTILES
<p>103S</p> <p>\$245</p>	<ul style="list-style-type: none"> GT Black Mesh Back Black Upholstered Seat Silver Frame Stacks 5 High Rated for 250 lbs Ships Four per Carton <p>** SPLIT CARTON FEE - \$25 NET</p>	<p>WIDTH: 18.0</p> <p>DEPTH: 23.5</p> <p>HEIGHT: 32.0</p> <p>SEAT WIDTH: 17.5</p> <p>SEAT DEPTH: 17.5</p> <p>SEAT HEIGHT: 18.0</p> <p>BACK WIDTH: 18.0</p> <p>BACK HEIGHT: 16.0</p> <p>WEIGHT: 14.0 LB</p>	<p>A00</p>	<p>BACK</p> <p>BLACK MESH M00</p> <p>SEAT</p> <p>BLACK 101</p>

MODEL	FEATURES	DIMENSIONS	ARM	TEXTILES
<p>176</p> <p>\$495</p>	<ul style="list-style-type: none"> M1 Control Multi-function Control 4-way Adjustable Arms Ratchet Back 3" Thick High Resilient Foam Seat Black Fabric Rated for 250 lbs Partially Assembled 	<p>WIDTH: 26.5</p> <p>DEPTH: 26.0</p> <p>HEIGHT: 39.0 - 46.5</p> <p>SEAT WIDTH: 22.0</p> <p>SEAT DEPTH: 18.5</p> <p>SEAT HEIGHT: 17.0 - 21.5</p> <p>BACK WIDTH: 20</p> <p>BACK HEIGHT: 20.5 - 23.5</p> <p>WEIGHT: 49.0 LB</p>	<p>A5</p> <p>4-way adjustable</p>	<p>BACK</p> <p>BLACK 101</p> <p>SEAT</p> <p>BLACK 101</p>

MODEL	FEATURES	DIMENSIONS	ARM	TEXTILES
<p>203</p> <p>\$395*</p>	<ul style="list-style-type: none"> Y1 Control Simple Synchro-tilt Control 2-way Height Adjustable Arms Black Mesh Back Air Grid Mesh Seat 3" Thick High Resilient Molded Foam Seat Rated for 250 lbs Assembly Required 	<p>WIDTH: 25.0</p> <p>DEPTH: 26.0</p> <p>HEIGHT: 39.0 - 43.5</p> <p>SEAT WIDTH: 20.0</p> <p>SEAT DEPTH: 17.5</p> <p>SEAT HEIGHT: 17.0 - 21.5</p> <p>BACK WIDTH: 18.0</p> <p>BACK HEIGHT: 22.0</p> <p>WEIGHT: 31.0 LB</p>	<p>A203</p> <p>2-way adjustable</p>	<p>BACK</p> <p>BLACK MESH M00</p> <p>SEAT</p> <p>BLACK AIR GRID MESH</p>

MODEL	FEATURES	DIMENSIONS	ARM	TEXTILES
<p>216</p> <p>\$545*</p>	<ul style="list-style-type: none"> Y1 Control Ratchet Back w/ Adjustable Lumbar 8-way Adjustable Arms Graphite Mesh Back Air Grid Mesh Seat 3" Thick High Resilient Foam Seat Rated for 250 lbs Assembly Required 	<p>WIDTH: 26.5</p> <p>DEPTH: 26.5</p> <p>HEIGHT: 39.0 - 46.0</p> <p>SEAT WIDTH: 21.0</p> <p>SEAT DEPTH: 20.0</p> <p>SEAT HEIGHT: 18.0 - 22.5</p> <p>BACK WIDTH: 20.5</p> <p>BACK HEIGHT: 21.0 - 24.0</p> <p>WEIGHT: 44.0 LB</p>	<p>A36</p> <p>8-way adjustable</p>	<p>BACK</p> <p>GRAPHITE MESH M31</p> <p>SEAT</p> <p>BLACK AIR GRID MESH</p>

MODEL	FEATURES	DIMENSIONS	ARM	TEXTILES
<p>217</p> <p>\$645*</p>	<ul style="list-style-type: none"> Y3 Control Full Synchro-tilt Control Graphite Mesh Seat Ratchet Back w/ Adjustable Lumbar 8-way Adjustable Arms Graphite Mesh Back Rated for 250 lbs Polished Aluminum Base Assembly Required 	<p>WIDTH: 26.5</p> <p>DEPTH: 26.5</p> <p>HEIGHT: 39.0 - 46.0</p> <p>SEAT WIDTH: 19.5</p> <p>SEAT DEPTH: 18.0</p> <p>SEAT HEIGHT: 17.5 - 22.0</p> <p>BACK WIDTH: 20.5</p> <p>BACK HEIGHT: 22.5 - 25.5</p> <p>WEIGHT: 46.0 LB</p>	<p>A36</p> <p>8-way adjustable</p>	<p>BACK</p> <p>GRAPHITE MESH M31</p> <p>SEAT</p> <p>GRAPHITE MESH M31</p>

arm guide

TASKING ARM OPTIONS

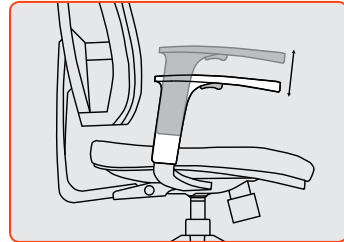

A2

\$80

ADJUSTABLE ARM

The A2 arm features height adjustment via a simple trigger mechanism under the arm pad. **Used with Brio and Y1, Y3, M1 controls only**

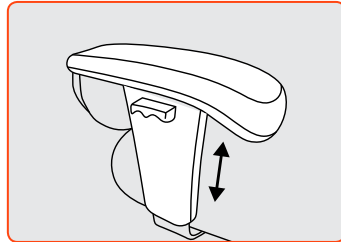

A4

\$75

ADJUSTABLE ARM

The A4 arm offers a soft touch polyurethane pad with 3" height adjustment. The arm pad features diamond padded anti-skid surface.

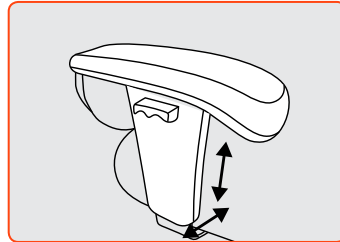

A5

\$95

MULTI-ADJUSTABLE ARM

The A5 arm is identical to the A4 arm but offers the added feature of a 4" arm width adjustment [activated via a knob under seat.

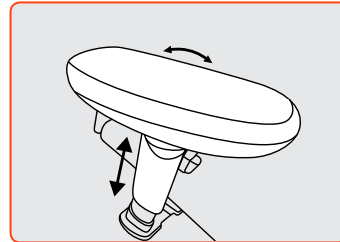

A6

\$130

ADJUSTABLE PIVOT/SWIVEL ARM

The A6 arm offers advanced features with Ura-Soft® arm pads. Features locking height adjustment, swivel pad, and adjustable arm pad position (slides forward and back).

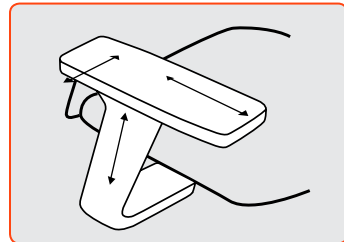

A23

\$75

MULTI-ADJUSTABLE ARM

6-Way Adjustable Arm Height, Width, and Forward Slide Adjustment



**A28/
A29**

\$100

HEIGHT ADJUSTABLE ARM

The A28 / A29 is an aluminum height adjustable arm with a fixed arm cap. **NOTE: A28 arms offer an additional 3" of interior width.**

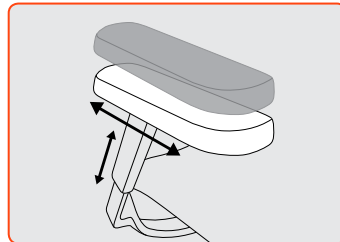

A30

\$125

MULTI-ADJUSTABLE ARM

The A30 is an aluminum 3 way adjustable tasking arm. Arms are height adjustable. The A30 pads slide forward/back and shift inward and outward for width adjustment.

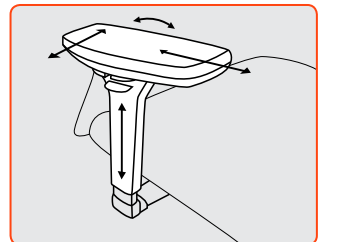

A36

\$105

ADJUSTABLE PIVOT/SWIVEL

8-Way Adjustable Arms
Soft-Touch sliding and pivoting arm pads

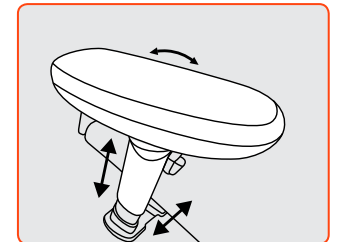

A7

\$150

MULTI-ADJUST. PIVOT/SWIVEL ARM

The A7 arm is identical to the A6 arm but offers the added feature of a 4" arm width adjustment activated via a knob under seat.

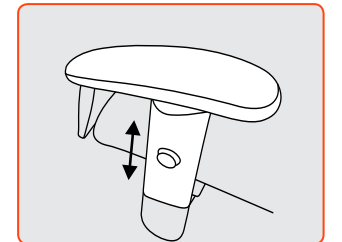

A8B/S

\$85

ADJUSTABLE ARM (BLACK)

The A8B height adjustable arm features push-button height adjustment with a range of 3.5". With matching black powder coated base

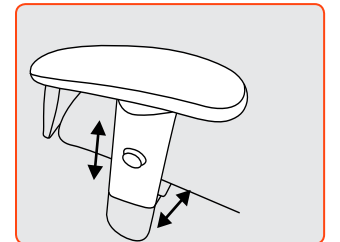

A9B/S

\$105

ADJUSTABLE ARM (BLACK)

The A9B arm is identical to the A8B arm but offers the added feature of 4" arm width adjustment activated via a knob under seat.

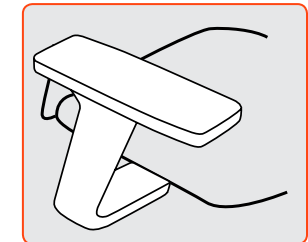

A22

\$50

FIXED ARM

Fixed Arm with Soft Polyurethane Pad

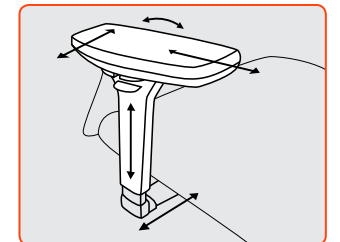

A37

\$125

MULTI-ADJUST. PIVOT/SWIVEL

10-Way Adjustable Arm, Soft-Touch sliding and pivoting arm pads. The A37 arm is identical to the A36 arm but offers the added feature of 4" arm width adjustment activated via a knob under seat.

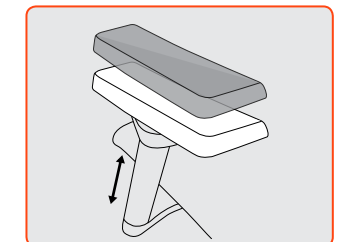

A40

\$110

ADJUSTABLE TASKING ARM

2-Way Adjustable Arm, Ratchet Height Adjustment with Fixed Arm Pad



A41

\$130

ADJUSTABLE TASKING ARM

6-Way Adjustable Arm Ratchet Height Adjustment with Side and Forward Sliding Arm Pad

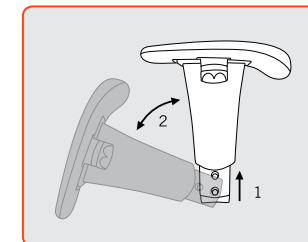

A90

\$200

BREAKAWAY ARM

Soft-touch polyurethane pad. 2.5" height adjustable. Use with all task series. Arms rotate back making chair armless. (pair)

FIXED ARM OPTIONS

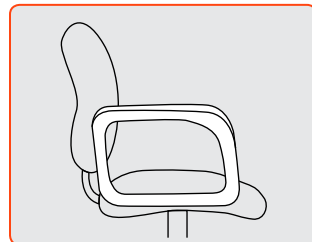

A1

\$70

LOOP ARM

Soft touch loop arm.

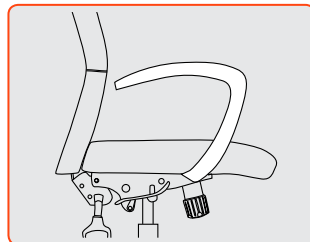

A10

\$85

CANTILEVER ARM

Soft touch cantilever arms provide sleek style and a durable surface. A great look for the office or conference room.

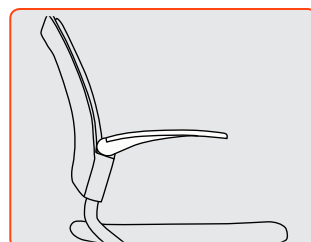

A12

\$45

FIXED ARM

For use on Bella only



A14

\$80

EXTENDED ARM

Reinforced soft touch extended arm. For use on the Bella only

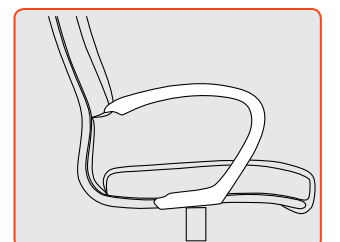

**A16/
A16P**

\$100/\$150

'C' ARM

A16 - Soft touch arm / A16P - Soft touch arm with upholstered pad

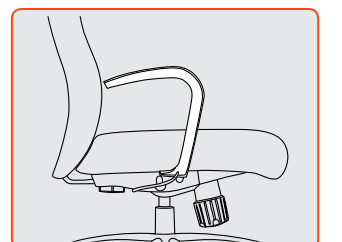

A19

\$200

CHROME CANTILEVER ARM

The A19 fixed arm offers a smooth polished aluminum surface with black plastic cap in an attractive cantilever style design.



A27



\$180

CHROME CANTILEVER ARM

The A27 fixed arm offers a smooth polished aluminum surface with black plastic cap in an attractive cantilever style design.

caster guide

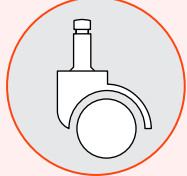
*Load Rating in (lbs) per caster/glide

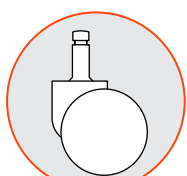
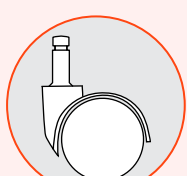
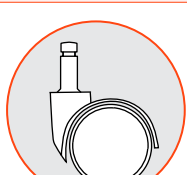
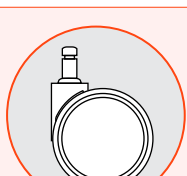
	C1 STANDARD CASTERS \$25	HOODED TWIN WHEEL CASTER WHEEL: 50 MM BARREL: 42 MM LOAD RATING: 110 LBS*	Best for use on carpeted surfaces. Hard nylon wheels are recommended for use on low-to-medium pile carpeting without padding. Dual wheels place more wheel surface on the carpet pile for optimum weight distribution. Wheels move in opposite directions to minimize carpet fiber twisting.
	C1S/C2S HARD FLOOR CASTERS (FIVE STAR BASE) \$35	HOODED TWIN WHEEL CASTER WHEEL: 50 MM/ BARREL: 42 MM LOAD RATING: 110 LBS*	Designed for use on hardwood floors, tile, chair mats, linoleum and concrete surfaces in an open office/workspace environment. (Lab, healthcare, classroom, and conference room.) Wheels are made from a soft polyurethane material. Set of five used with star bases. C2S -The wheels feature auto-lock; The safety brakes engage when the chair is not in use, this prevents the chair from rolling away when standing up.
	C4 HEAVY DUTY CASTER \$35	HOODED TWIN WHEEL CASTER WHEEL: 60 MM BARREL: 38 MM LOAD RATING: 140 LBS*	Recommended when higher weight capacity is required. Large diameter hard nylon wheels designed for use on low- to medium-pile carpeting with or without padding. Large diameter dual wheels place more wheel surface on the carpet pile for optimum weight distribution. Wheels move in opposite directions to minimize carpet fiber twisting.
	C5 STANDARD CASTER (SHUTTLE AND BELLA GUEST CHAIRS) \$25	HOODED TWIN WHEEL CASTER WHEEL: 50 MM BARREL: 27 MM LOAD RATING: 110 LBS*	Best for use on carpeted surfaces. Hard nylon wheels are recommended for use on low- to medium-pile carpeting without padding. Dual wheels place more wheel surface on the carpet pile for optimum weight distribution. Wheels move in opposite directions to minimize carpet fiber twisting. Set of four used on guest chairs.
	C5S HARD FLOOR CASTER (FOUR LEG GUEST CHAIRS) \$30	HOODED TWIN WHEEL CASTER WHEEL: 50 MM BARREL: 13 MM LOAD RATING: 110 LBS*	Designed for use on hardwood floors, tile, chair mats, linoleum and concrete surfaces in an open office/workspace environment. (Lab, healthcare, classroom, and conference room.) Wheels are made from a soft polyurethane material. Set of four used on guest chairs.
	C6 LARGE DIAMETER CASTER \$30	TWIN WHEEL CASTER WHEEL: 60 MM BARREL: 25 MM LOAD RATING: 140 LBS*	Recommended for use on carpeted surfaces. Large diameter hard nylon wheels are recommended for use on low to medium pile carpeting with or without padding. 60 mm dual wheels place more wheel surface on the carpet pile for optimum weight distribution and ease of movement. Wheels move in opposite directions to minimize carpet fiber twisting.
	C6S HARD FLOOR LARGE DIAMETER CASTER (FIVE STAR BASE) \$35	TWIN WHEEL CASTER WHEEL: 60 MM BARREL: 25 MM LOAD RATING: 140 LBS*	Designed for use on hardwood floors, tile, chair mats, linoleum and concrete surfaces in an open office/workspace environment. (Lab, healthcare, classroom, and conference room.) Wheels are made from a soft polyurethane material. Set of five used with star bases.

PARTS AND ACCESSORIES DISCOUNT

INDIVIDUAL PARTS & ACCESSORIES WHEN PURCHASED SEPARATE FROM A CHAIR RECEIVE AN EVEN 50% DISCOUNT. THE 50% ACCESSORY DISCOUNT PROVIDES FOR EXTRA LABOR, PACKAGING MATERIAL AND SHIPPING CHARGES ASSOCIATED WITH SHIPPING A COMPONENT BY ITSELF.

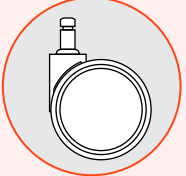
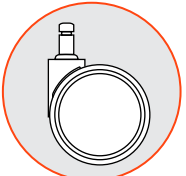
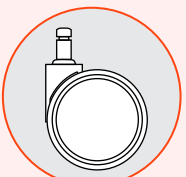
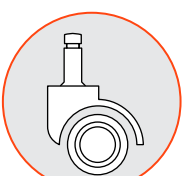
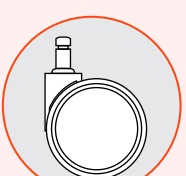
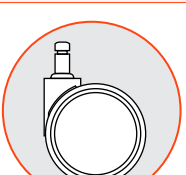
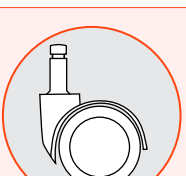
	C7 60MM CHROME ACCENTED HOODLESS CASTERS \$35	TWIN WHEEL CASTER WHEEL: 60 MM BARREL: 25 MM LOAD RATING: 140 LBS*	Recommended for use on carpeted surfaces. Large diameter hard nylon wheels are recommended for use on low to medium pile carpeting with or without padding. 65mm dual wheels place more wheel surface on the carpet pile for optimum weight distribution and ease of movement. Wheels move in opposite directions to minimize carpet fiber twisting. Standard with A19 base.
	C8S HARD FLOOR LARGE DIAMETER CASTER \$35	TWIN WHEEL CASTER WHEEL: 75 MM BARREL: 22 MM LOAD RATING: 160 LBS*	Recommended for use on carpeted or hard surfaces. Large diameter soft nylon wheels are recommended for use on low to medium pile carpeting with or without padding. 75mm dual wheels place more wheel surface on floors for optimum weight distribution and ease of movement. Wheels move in opposite directions to minimize carpet fiber twisting.
	C9S COMPRESSION LOCKING HARD FLOOR CASTER \$40	HOODED TWIN WHEEL CASTER WHEEL: 50 MM BARREL: 42 MM LOAD RATING: 110 LBS*	Designed for use on hardwood floors, tile, chair mats, linoleum and concrete surfaces in an open office/workspace environment. (Lab, healthcare, classroom, and conference room.) The wheels feature compression-lock; The brakes engage when the user is seated in the chair. When seated this prevents the user from rolling away from the work surface.
	C10S SELF-LOCKING HARD FLOOR CASTER \$50	TWIN WHEEL CASTER WHEEL: 50 MM BARREL: 18 MM LOAD RATING: 110 LBS*	Designed for use on hardwood floors, tile, chair mats, linoleum and concrete surfaces in an open office/workspace environment. (Lab, healthcare, classroom, and conference room.) The wheels feature auto-lock; The safety brakes engage when the chair is not in use, this prevents the chair from rolling away when standing up.
	C11S COMPRESSION LOCKING HARD FLOOR CASTER \$50	TWIN WHEEL CASTER WHEEL: 50 MM BARREL: 18 MM LOAD RATING: 110 LBS*	Designed for use on hardwood floors, tile, chair mats, linoleum and concrete surfaces in an open office/workspace environment. (Lab, healthcare, classroom, and conference room.) The wheels feature compression-lock; The brakes engage when the user is seated in the chair. When seated this prevents the user from rolling away from the work surface.
	C12 STANDARD CASTER (LINK) \$50	TWIN WHEEL CASTER WHEEL: 50 MM BARREL: RECTANGULAR LOAD RATING: 110 LBS*	Best for use on carpeted surfaces. Hard nylon wheels are recommended for use on low-to-medium pile carpeting without padding. Dual wheels place more wheel surface on the carpet pile for optimum weight distribution. Wheels move in opposite directions to minimize carpet fiber twisting. C12 wheels match the rectangular tubing of the Link chair.
	C22 STANDARD 60MM HUBLESS CASTER (CORE) \$35	TWIN WHEEL CASTER WHEEL: 60 MM BARREL: 25MM LOAD RATING: 110 LBS*	Recommend for use on Carpet or Hard floors. Wheels made of Polyurethane. Available in Black or Gray accents. Stylish hubless design.

glide guide

*Load Rating in (lbs) per caster/glide

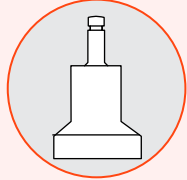
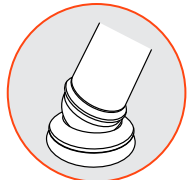
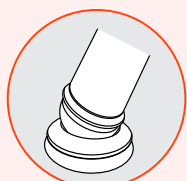
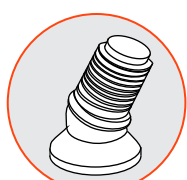
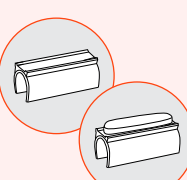
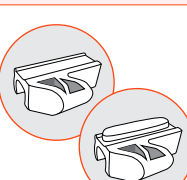
	G1 STATIONARY BASE GLIDE \$30	HIGH BASE GLIDE FOR 5 STAR BASE LOAD RATING: 110 LBS*	Glide provide the best stationary support. Use only when a stationary position is desired. The glide height is the same as the caster height. Do not use on hard floor if marring is a concern.
	G8 SELF-LEVELING METAL GLIDE \$20	METAL BASE GLIDE FOR 4 LEG GUEST CHAIRS LOAD RATING: 150 LBS*	Metal self-leveling base glide are used as an alternate to standard nylon glides. The metal glide offers a 100% increase in weight capacity. The self-leveling articulation allows the glide to flatten against uneven floors for better weight distribution. For use on all surfaces.
	G9 SELF-LEVELING VCT GLIDE \$30	VCT BASE GLIDE FOR 4 LEG GUEST CHAIRS LOAD RATING: 150 LBS*	Metal self-leveling base glide with white VCT cap are used as an alternate to standard nylon glides. The VCT glide also offers a 100% increase in weight capacity. The self-leveling articulation allows the glide to flatten against VCT floors for better weight distribution and the white nylon cap protects VCT floors against marring and visible streaking.
	G10 SELF-LEVELING PLASTIC GLIDE WITH FELT BASE \$30	FELT BASE ROUND PLASTIC GLIDE FOR 4 LEG GUEST CHAIRS IDEAL FOR WOOD OR SOFT COMPOSITE FLOORS LOAD RATING: 110 LBS*	Plastic self-leveling base glide with felt base. Felt base offers additional protection against marring especially on wood or soft composite surfaces
	G12/G13 CLEAR PLASTIC RECTANGULAR GLIDE (G13 W/ FELT BASE) SLED BASE CLEAR PLASTIC GLIDE FOR INDY & KELLEY SLED BASE (G13 W/ FELT BASE) \$15/\$25	LOAD RATING: 90 LBS*	G12 Clear plastic rectangular glide for the Indy and Kelley sled base. Ideal for use on light-colored floors where streaking may be a concern G13 Clear plastic rectangular glide with felt base to provide additional protection on wood or soft composite floors where marring or streaking is a concern
	G14/G15 SLED BASE PLASTIC GLIDE (G15 W/ FELT BASE) \$15/\$25	PLASTIC GLIDE (G15 W/ FELT BASE) FOR SLED BASE INDY CHAIR LOAD RATING: 90 LBS*	G14 Plastic glide for the Indy sled base. Ideal for use on light-colored floors where streaking may be a concern G15 Plastic glide with felt base to provide additional protection on wood or soft composite floors where marring or streaking is a concern

cylinder guide

MODEL	SS	CONTROLS	CYLINDER	STROKE	BASE	CASTER
1125		T1	CYL190	5"	BA9	C12
1126		T1	CYL360	10"	BA9	C12
1128		T1	CYL300	8"	BA9	C12
1325		B2, S3	CYL240	5"	BA9	C6
1326		B2	CYL360	10"	BA9	C6
1328		B2	CYL300	8"	BA9	C6
1336		B2	CYL360	10"	BA9	C6
1338		B2	CYL300	8"	BA9	C6
1425		B2	CYL240	5"	BA1	C1
1425		S2, P1, R1, M1	CYL190	5"	BA1	C1
1425	SS	S2, P1, R1, M1	CYL190	5"	BA1	C1
1425	SS	Y2	CYL160	3"	BA1	C1
1426		B2, P1	CYL360	10"	BA1	C1
1428		B2, P1	CYL300	8"	BA1	C1
1460		Y1, Y3	CYL190	5"	BA9	C6
1460		K2	CYL160	3"	BA9	C6
1466		Y1	CYL360	10"	BA9	C6
1468		Y1	CYL300	8"	BA9	C6
1535/1537		Y1	CYL190	5"	BA1	C4
1535/1537	SS	Y1	CYL190	5"	BA1	C4
1536		Y1	CYL360	10"	BA1	C4
1538		Y1	CYL300	8"	BA1	C4
1545/1555		Y1	CYL190	5"	BA1	C4
1545/1555	SS	Y1	CYL160	3"	BA1	C4
1546		Y1	CYL360	10"	BA1	C4
1548		Y1	CYL300	8"	BA1	C4
1560/1580		Y2	CYL190	5"	BA2S	C4
1560/1580	SS	Y2	CYL160	3"	BA2S	C4
1566		Y2	CYL360	10"	BA2B	C4
1568		Y2	CYL300	8"	BA2B	C4
1570/1590		Y2	CYL190	5"	BA2S	C4
1570/1590	SS	Y2	CYL160	3"	BA2S	C4
1576		Y2	CYL360	10"	BA2B	C4
1578		Y2	CYL300	8"	BA2B	C4
1660		B2	CYL240	5"	BA1	C1
1660		S2, P1, R1, M1	CYL190	5"	BA1	C1
1660	SS	S2, P1, R1, M1	CYL190	5"	BA1	C1
1660	SS	Y2	CYL160	3"	BA1	C1
1666		B2, P1	CYL360	10"	BA1	C1
1668		B2, P1	CYL300	8"	BA1	C1
1725		B2	CYL240	5"	BA1	C1
1725		S2, R1, M1	CYL190	5"	BA1	C1
1725	SS	S2, R1, M1	CYL190	5"	BA1	C1
1726		B2, P1	CYL360	10"	BA1	C1
1728		B2, P1	CYL300	8"	BA1	C1
1760		S2, P1, R1, M1, Y2	CYL190	5"	BA1	C1
1760	SS	S2, P1, R1, M1	CYL190	5"	BA1	C1
1760	SS	Y2	CYL160	3"	BA1	C1
1766		P1	CYL360	10"	BA1	C1
1768		P1	CYL300	8"	BA1	C1

MODEL	SS	CONTROLS	CYLINDER	STROKE	BASE	CASTER
1780		S2, P1, R1, M1, Y2	CYL190	5"	BA1	C1
1780	SS	S2, P1, R1, M1	CYL190	5"	BA1	C1
1780		Y2	CYL160	3"	BA1	C1
1790	SS-STD	M2	CYL197HD	5"	BA1	C4
1860		Y1, Y3	CYL190	5"	BA9	C6
1866		Y1	CYL360	10"	BA9	C6
1868		Y1	CYL300	8"	BA9	C6
1880		Y4	CYL160	3"	BA9	C6
1960		M1, Y2	CYL190	5"	BA2B	C4
1960	SS	M1, Y2	CYL190	5"	BA2B	C4
1966		P1	CYL360	10"	BA2B	C4
1968		P1	CYL300	8"	BA2B	C4
1980		M1, Y2	CYL190	5"	BA2B	C4
1980	SS	M1, Y2	CYL190	5"	BA2B	C4
2060/2070		Y1, Y3, M1	CYL190	5"	BA9	C6
2066/2076		P1	CYL360	10"	BA9	C6
2068/2078		P1	CYL300	8"	BA9	C6
2160/2180	SS	Y1, Y2, Y3	CYL190	5"	BA9	C6
2170/2190	SS	Y1, Y2, Y3	CYL190	5"	BA9	C6
2166			CYL360	10"	BA9	C6
2168			CYL300	8"	BA9	C6
2260		K2, W1, Y5	CYL190	5"	BA9	C22
2360/2380		S2, R1, M1, Y2	CYL190	5"	BA9	C6
2360/2380	SS	S2, R1, M1	CYL190	5"	BA9	C6
2360/2380	SS	Y2	CYL160	3"	BA9	C6
2366		P1	CYL360	10"	BA9	C6
2368		P1	CYL300	8"	BA9	C6
2450		S3	CYL200	5"	BA10P	C6
2450		B2	CYL200	5"	BA10P	C6
2600		S1	CYL190	5"	BA1	C1
2600		K1	CYL160	3"	BA1	C1
2610		S1	CYL190	5"	BA1	C1
2610		K1	CYL160	3"	BA1	C1
2780	SS	W2, Y2, Y5	CYL200	5"	BA11B	C6
2800		S1	CYL200	5"	BA2B/BA2P	C1
2800		K1	CYL160	3"	BA2B/BA2P	C1
2810		S1	CYL190	5"	BA2B/BA2P	C1
2810		K1	CYL160	3"	BA2B/BA2P	C1
2900/2910		S2, M1, Y2	CYL200	5"	BA19	C7
3060/3065	SS-STD	X1	CYL200	5"	BA10	C8S
3080/3085		X1	CYL200	5"	BA10	C8S
3061/3066		X1	CYL360	10"	BA10	C8S
3063/3068	SS-STD	X1	CYL300	8"	BA10	C8S
3200/3210	SS-STD	X2, S3	CYL200	5"	BA10P	C6
3220/3230	SS-STD	X2	CYL200	5"	BA10P	C6
3250/3260		X2	CYL200	5"	BA10P	C6
3300/3310		K3	CYL190	5"	BA9	C6
3306		S3	CYL360	10"	BA9	C6
3308		S3	CYL300	8"	BA9	C6

accessories

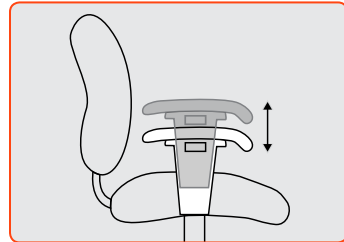

PA4

\$20

SOFT-TOUCH POLYURETHANE PAD ONLY

Use w/ A4, A5 Arm
(ea)

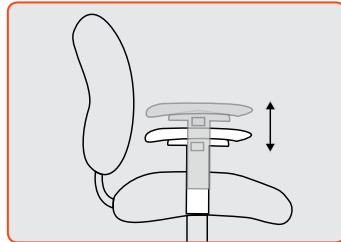

PA6

\$30

URA-SOFT® PAD ONLY

Use w/ A6, A7 Arm
(ea)

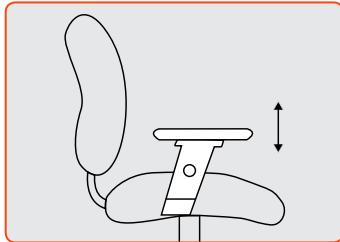

PA8

\$25

SOFT-TOUCH POLYURETHANE PAD ONLY

Use w/ A8, A9 Arm
(ea)

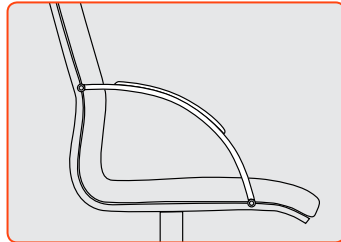

PA20

\$25

LEATHER PAD ONLY

Use w/ A20, A21 Arm
(ea)



PA22

\$50

SOFT-TOUCH POLYURETHANE PAD ONLY

Use w/ A30 Arm
(price per individual pad, specify L or R)



PA30

\$50

SOFT-TOUCH POLYURETHANE PAD ONLY

Use w/ A30 Arm
(price per individual pad, specify L or R)



PA38

\$50

SOFT-TOUCH POLYURETHANE PAD ONLY

Use w/ A30 Arm
(price per individual pad, specify L or R)

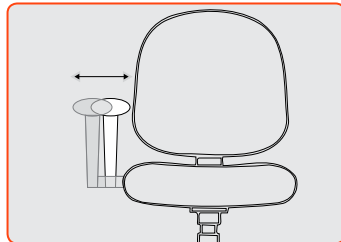

AW1

\$25

4" ARM WIDTH ADJUSTMENT BRACKET

Use w/ A4, A6, A8, A22
(pair)

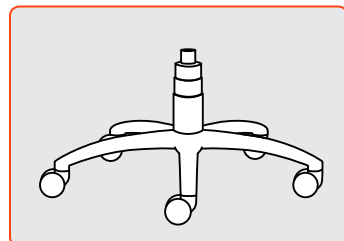

BA1

\$75

27" BLACK NYLON BASE

Use w/ all Task, Management, & Executive Chairs (casters sold separately)

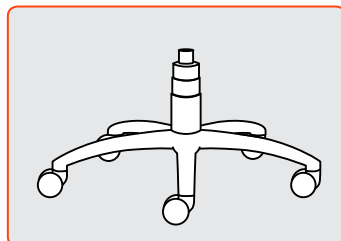

BA2B,S,P

\$100

**27" ALUMINUM BASE
B - BLACK POWDER COATED BASE
S - SILVER POWDER COATED BASE
P - POLISHED ALUMINUM BASE**

Use w/ all Task, Management, & Executive Chairs (casters sold separately)

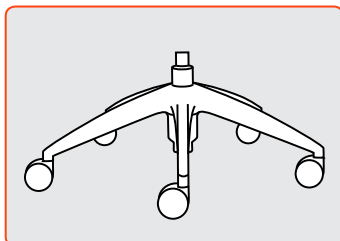

BA9

\$75

26" BLACK NYLON BASE

26" High Profile Black Nylon Base comes standard w/ C6 65mm Hoodless Casters

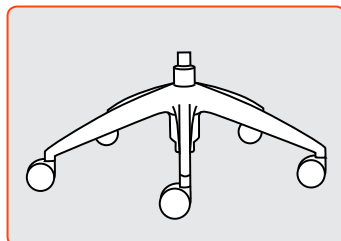

BA10B,S,P

\$100

**26" HIGH PROFILE ALUMINUM BASE
B - BLACK POWDER COATED BASE
S - SILVER POWDER COATED BASE
P - POLISHED ALUMINUM BASE**

High Profile Black Powder Coated Aluminum Base (casters sold separately)

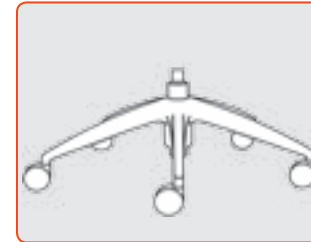

BA11

\$75

**27" MID-PROFILE PLASTIC BASE
B - BLACK PLASTIC
G - GRAY PLASTIC**

Mid-Profile Plastic Base
(casters sold separately)

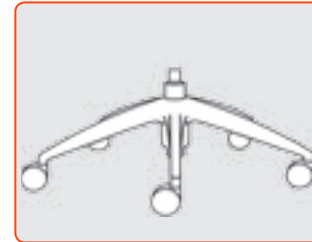

BA12P

\$100

27" POLISHED ALUMINUM BASE

High Profile Polished Aluminum Base
(casters sold separately)

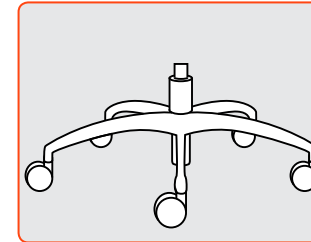

BA19

\$125

27" POLISHED ALUMINUM BASE

Use with all Task, Management, & Executive Chairs (includes matching casters with polished aluminum accents)

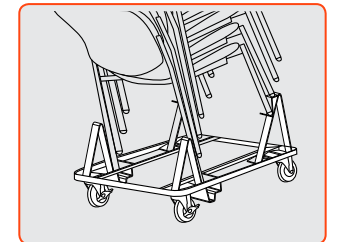

DL1

\$250

STACKING DOLLY

Use w/ Shuttle, Bella, and Link four leg



DL4

\$250

STACKING DOLLY

Stacks Indy and Kelly all plastic Chairs up to 33 High.

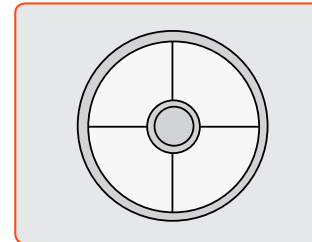

FR20B

\$90

20" BLACK KNOB LESS FOOTRING

Use with any Stool (standard on Cydia)

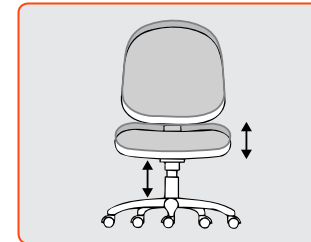

CYL160

\$30

PNEUMATIC CYLINDER 3" LIFT

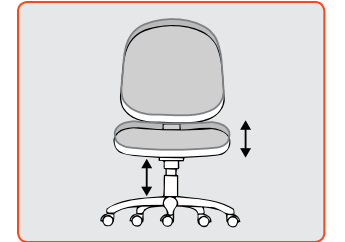

CYL190

\$30

PNEUMATIC CYLINDER 5" LIFT

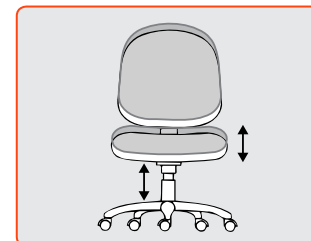

CYL200C

\$30

PNEUMATIC CYLINDER 5" LIFT W/ CHROME FINISH

Use w/ Cortina, Vesta series or any chrome base



CYL200B

\$30

PNEUMATIC CYLINDER 5" LIFT W/ BLACK FINISH

Use w/ Vesta series

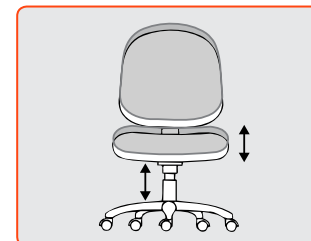

CYL240

\$30

PNEUMATIC CYLINDER 5" LIFT

PARTS AND ACCESSORIES DISCOUNT

INDIVIDUAL PARTS & ACCESSORIES WHEN PURCHASED SEPARATE FROM A CHAIR RECEIVE AN EVEN 50% DISCOUNT.

THE 50% ACCESSORY DISCOUNT PROVIDES FOR EXTRA LABOR, PACKAGING MATERIAL AND SHIPPING CHARGES ASSOCIATED WITH SHIPPING A COMPONENT BY ITSELF.

accessories

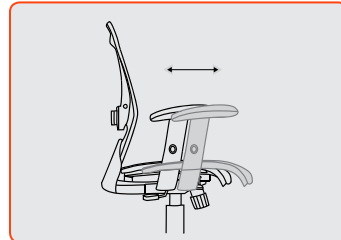

SS

\$60

SEAT SLIDER 2.5" SIDE PADDLE ACTIVATED

Add to S2, R1, M1, Y2 Controls Only on Select Series*

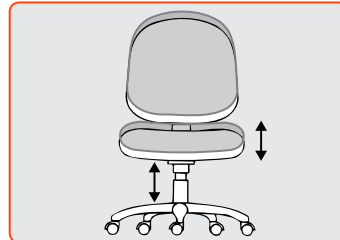

**CYL300
CYL360**

\$45/\$45

**PNEUMATIC CYLINDER 8" LIFT/
PNEUMATIC CYLINDER 10" LIFT**

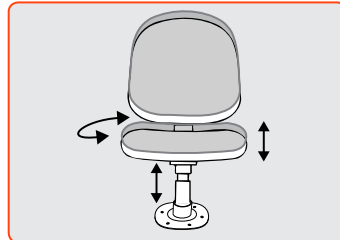

CYL-ARH

\$110

**SELF HEIGHT & FORWARD RETURNING
PNEUMATIC CYLINDER 5" LIFT**
Upon exiting chair the seat returns to standard height & forward position for use with JB1 Jury Base

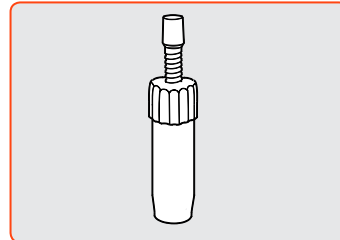

CYLTHSPD

\$60

THREADED SPINDLE CYLINDER
Replaces standard CYL190 gas lift for applications where the client does not want the chair height to be easily changed; such as conference rooms, cafeterias
*Not compatible with BA9

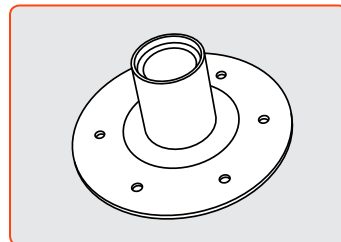

JB1

\$300

STANDARD JURY BASE

Use w/ all task models
Consists of round plate which is bolted to floor and receives pneumatic cylinder

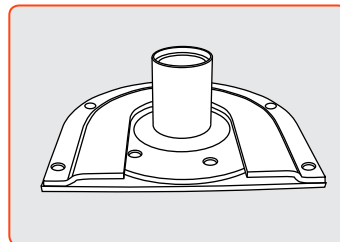

JB2

\$675

QUICK RELEASE JURY BASE

Use w/ all task models
Pedestal base with quick release to remove chair and cylinder (includes JB1)

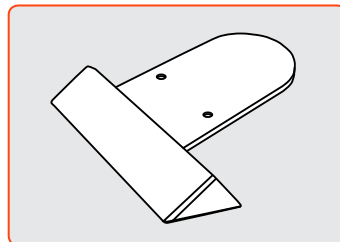

JB2-PLT

\$100

RAMP INSERT FOR JB2 JURY BASE

Use w/ JB2 Insert when chair & cylinder removed for ADA compliance

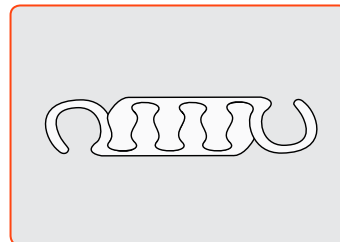

GC1

\$30

**GANGING CLIP
ARMLESS-TO-ARMLESS**

Distance between chairs is 1.25"
Use w/ Shuttle, Bella (2 per set)

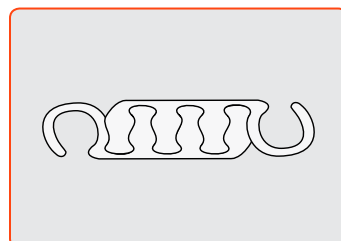

GC2

\$30

**GANGING CLIP
ARM-TO-ARM**

Distance between chairs is 4.25"
Use w/ Shuttle, Bella (2 per set)

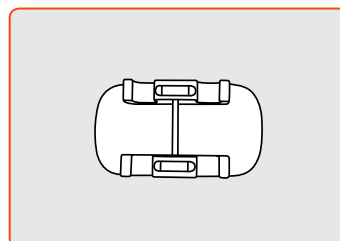

GC5

\$20

**GANGING CLIP
ALL INDY SERIES AND
KELLEY ARMLESS CHAIRS**

Distance between chairs is 2.00"
Use with All Indy and Kelley armless only



**HR-3080-
M1X**

\$150

HEADREST

Use w/ Vesta series. Pattern "M1" mesh specify: M11-Black, M12 Gray, M13 Silver, M14 Green, M15 Red, M16 Blue.
Also specify bracket finish:
PF-Polished, SF-Silver, BF-Black

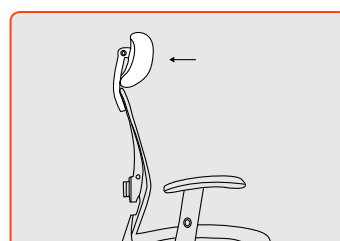

HR-1580-T01

\$120

HEADREST

Use w/ Strata series.
T01 black mesh only (other upholstery contact customer service)

PARTS AND ACCESSORIES DISCOUNT

INDIVIDUAL PARTS & ACCESSORIES WHEN PURCHASED SEPARATE FROM A CHAIR RECEIVE AN EVEN 50% DISCOUNT. THE 50% ACCESSORY DISCOUNT PROVIDES FOR EXTRA LABOR, PACKAGING MATERIAL AND SHIPPING CHARGES ASSOCIATED WITH SHIPPING A COMPONENT BY ITSELF.

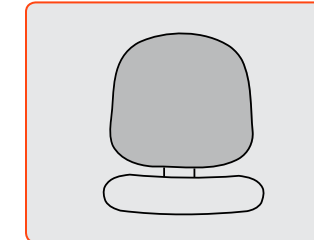

UB

\$100

UPHOLSTERED OUTER BACK COVERED WITH FABRIC

Use w/ Enduro

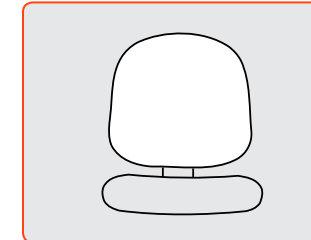

**BN1
BN2**

\$35/NC

UPHOLSTERED BACK COVERED WITH BLACK BALLISTIC NYLON

BN1 - Use with Grade A Fabrics
BN2 - Use with Grade B & Up Fabrics
Use w/ Logic, Precept, & Shuttle

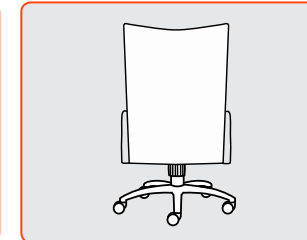

BNE

\$150

UPHOLSTERED BACK COVERED WITH BLACK BALLISTIC NYLON

Use w/ Axis, Cayman only

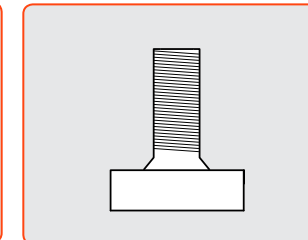

BT

\$15

BOLT

Replace knob with bolt (for B2 and S2 controls only)

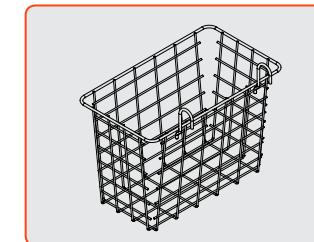

BSK

\$60

BELLA SIDE HANGING BASKET

Side Hanging Wire Basket for model 1310, 1315, 1360, 1365. Attach to left or right side.

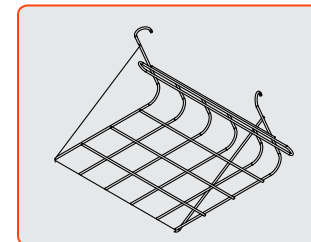

BRK

\$70

SHUTTLE BOOK RACK

Book Rack in Black Only
Available on Shuttle

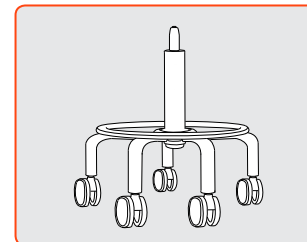

KIT-FST8

\$150

8" GAS LIFT, 20" CHROME FIXED FOOTRING W/ 75MM HARD FLOOR CASTERS

Durable Classic Fixed Foot ring Base for Lab Stool, Service Counter, Security Guard, and Medical Applications. A Real Workhorse.

CYLINDER REFERENCE GUIDE

PART #	Stroke	Note
CYL160	3"	Short, reduced range cylinder used to offset added height of SS seat slider or K1 control
CYL190	5"	Standard task cylinder with lower starting height than CYL240. May be substituted for CYL240 when lower starting seat height is required
CYL197	5"	5" Stroke Heavy duty task cylinder
CYL200	5"	Standard task cylinder only used for high profile bases (BA10, ba19)
CYL240	5"	Standard task cylinder with higher starting height than CYL190. May be substituted for CYL190 when higher starting seat height is required
CYL300	8"	Stool cylinder with 2" lower starting seat height than stools with CYL360. Typically seat height starts at 19" so chair may be pushed under some desks. Use for workstations up to 36 inches high
CYL360	10"	Stool cylinder with 2" higher starting seat height than stools with CYL300. Generally seat height starts at 21" and chair will not fit under most desks. Use for workstations up to 42 inches high
CYLTHSPD	2.5"	Cylinder with a threaded spindle rather than a gas lift. For applications where client prefers the seat height set and not easily changed, such as a conference room
CYL-ARH	5"	Self height and forward position return. For use with jury base option

control selection guide

CONTROL FUNCTION GUIDE

1	INFINITE BACK ANGLE ADJUSTMENT	7	INFINITE POSITION TILT-LOCK
2	SEAT HEIGHT LEVER	8	FORWARD TILT LEVER
3	BACK DEPTH CONTROL KNOB	9	EASY-LIFT RATCHET BACK HEIGHT CONTROL
4	ARTICULATING POSTURE BACK W/ FREE FLOAT	10	BACK MULTI-LOCK W/ SAFETY RELEASE
5	SEAT HEIGHT & TILT LOCK LEVER	11	SEAT SLIDER PADDLE
6	TILT TENSION CONTROL KNOB	12	4 POSITION BACK TRAVEL CONTROL

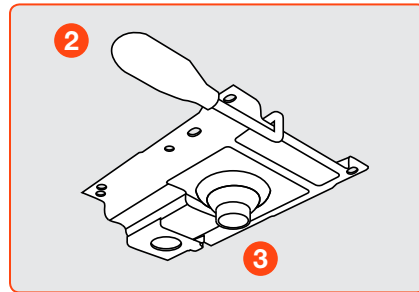

B2 Basic Task - 1 Paddle

Our basic control has simple adjustments. Ideal for clerical, casual meeting, and general office use. This control uses a 2.25" Cold-Rolled Steel J-Bar for added strength and back-pull durability.

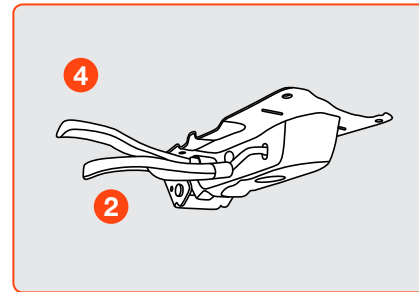

P1 Posture Back - 2 Paddle

Ideal for stool applications, the articulating back provides proper support for moderate tasking use.

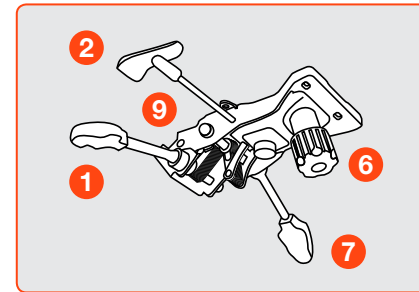

R1 Rocking - 3 Paddle

For managerial and task applications. Similar to a swivel-tilt control with the added comfort of infinite back-angle adjustment and infinite tilt lock. Features 3" Cold-Rolled Steel J-Bar.

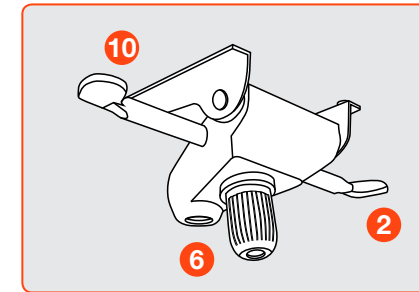

K1 Knee Tilt - 2 Paddle

Ultimate seating comfort suited for the executive or manager. Allows for a full range of movement with a reduced rise of front seat edge. 5 position multi-lock with built-in safety return feature.

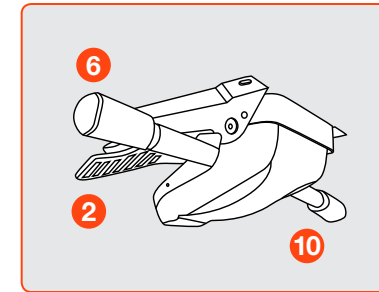

K2 Knee Tilt - 2 Paddle

Ultimate seating comfort for manager, executive or conference seating. Allows for a full range of movement with a reduced rise of front seat edge. 4-position multi lock back. Side tension and back lock

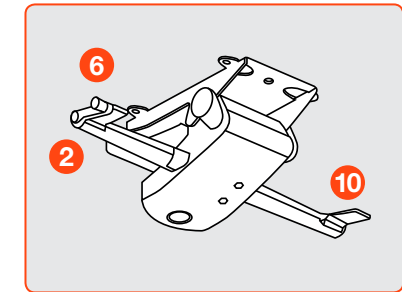

K3 Knee Tilt - 2 Paddle (for Cydia only)

Ultimate seating comfort for manager, executive or conference seating. Allows for a full range of movement with a reduced rise of front seat edge. 4-position multi lock back. Side tension and back lock

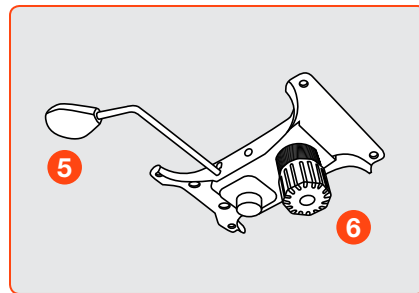

S1/S3 Swivel - Tilt - 1 Paddle

Use for a variety of general office seating, including private office and conference room seating. Control locks upright for tasking.

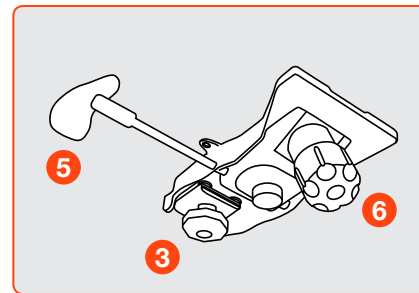

S2 Swivel - Tilt - 1 Paddle

Use for a variety of general office seating. Similar function to the S1, however utilizing a 2.25" Cold-Rolled Steel J-Bar to connect seat and back. Control locks upright for tasking.

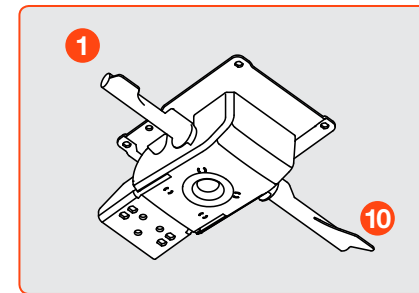

W1 Weight Balanced

Auto-Balance tension adjustment utilizes the weight of the user to balance resistance of back. 3:1 back to seat synchronous movement with 2 position back lock.

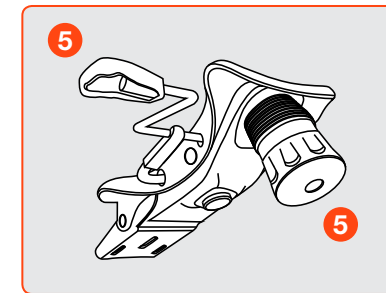

Y1 Simple Synchro Tilt 1 Paddle

Recline with a synchro back and seat movement. Reduced rise of front seat edge. Back may free float or be locked upright. Comparable to swivel tilt control but with asynchronous movement.

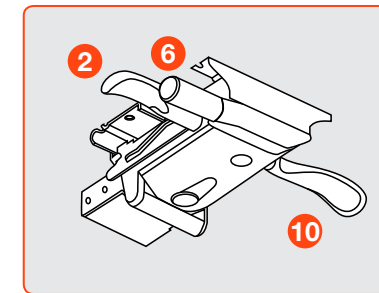

Y2 Synchro Tilt - 2 Paddle

Recline with a synchro back and seat movement featuring a 2:1 back to seat tilt ratio. Reduced rise of front seat edge. 4 position multi-lock with built-in safety return feature and slide tension control.

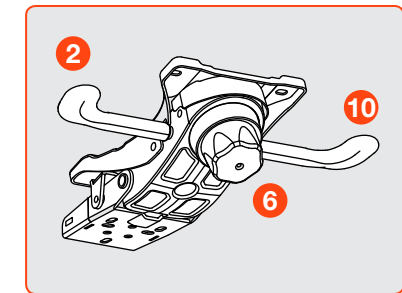

Y3 Synchro Tilt - 2 Paddle

Recline with a synchro back and seat movement featuring a 2:1 back to seat tilt ratio. Reduced rise of front seat edge. 3 position multi-lock with built-in safety return feature.

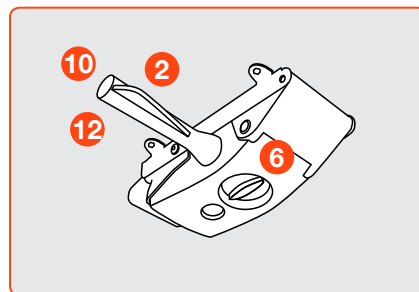

W2 Weight Balanced - Back Travel Control

Auto-Balance tension adjustment utilizes the weight of the user to balance resistance of back. Sensing can be adjusted to suit individual preference. 3:1 back to seat synchronous movement with 4 position back-travel limiting lock.

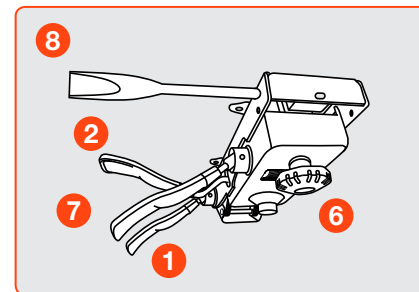

M1 Multi-Function - 4 Paddle

For the highest level of ergonomic needs, suited for multi-task functions. Seat pivots from 0 to 6 degrees forward. 3.00" wide Cold Rolled Steel J-Bar adds strength and back-pull durability.

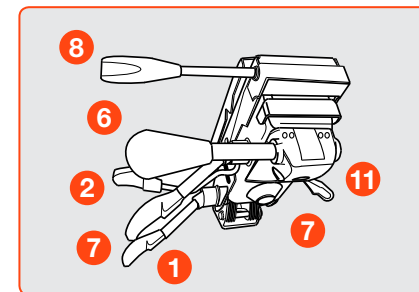

M2 Heavy Duty Multi-Function - 4 Paddle

With a weight capacity up to 500 lbs, in addition to multi-task ergonomic functions, its ideal for police departments, 911 emergency, hospitals or whenever a higher weight capacity is needed. A 3.00" wide 5/16" thick cold rolled steel back support adds strength and back-pull durability.

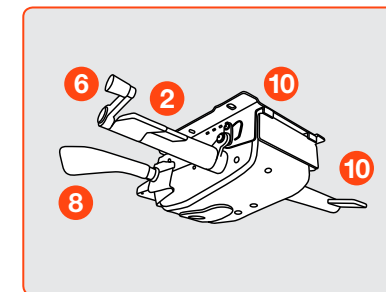

Y4 Synchro Tilt - 3 Paddle (for Aria HR only)

Recline with a synchro back and seat movement featuring a 2:1 back to seat-tilt ratio. Reduced rise of front seat edge. 4 position multi-lock back position with built-in safety return feature. Integrated seat slider.

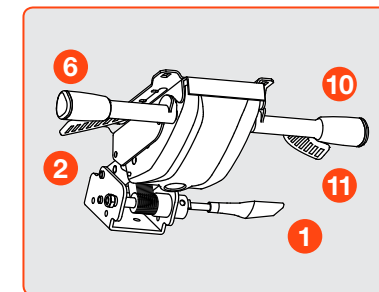

Y5 Full Synchro - Paddle (for Core and Acclaim)

Enjoy the ride with this high function full 2:1 synchro control featuring an independent back angle adjustment. 4 position back lock, side tension control and built in seat slider depth adjustment.

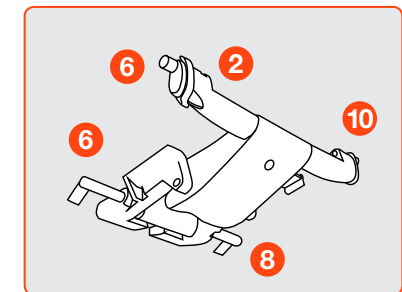

X1/X2 X1 for Vesta Chairs X2 for Cosmo Chairs

Synchro Tilt - 2 Paddle. Recline with a synchro back and seat movement featuring a 2:1 back to seat tilt ratio. Reduced rise of front seat edge. 11 position multi-lock with built-in safety return feature. Integrated seat slider and forward pitch adjustment.

BIFMA Ultimate test for fit (UTFF)

Ergonomics - The Work Chair

The Business and Institutional Furniture Manufacturer's Association (BIFMA) has developed the following guidelines for UTFF. Parenthetical numbers following each item indicate corresponding subdivisions in the guidelines.

Seat Height (7.1)

Users should be able to sit with their feet comfortably on the floor or footrest without undue pressure on the underside of the thighs. The thigh-to-torso angle should not be less than 90°.

Seat Depth (7.2)

Users should be able to sit in the chair without undue pressure against the back of the knees, their back properly supported by the backrest and with adequate buttock and thigh support.

Seat Width (7.3)

The seat should be wider than the hip breadth of the user with allowance for movement and clothing. The seat width should not limit the ability to use the armrests comfortably.

Seat Pan Angle (7.4)

This should allow users to support their feet on the floor or footrest. They should not cause the user's torso-to-thigh angle to be less than 90°. Forward seat pan angles should not cause users to shift excessive weight to their feet or experience the sensation of sliding out of the chair.

Back Support (7.5)

Seat Backrest Height (7.5.1)

All backrests should provide adequate support and buttocks clearance. For tasks requiring upper body mobility, the backrest should not interfere with the user's movement. For users who prefer reclining postures or greater upper back support, the back height should provide support for the shoulder blades.

Backrest Width (7.5.2)

The width of the backrest should provide adequate support for the curvature of the user's back without causing localized pressure points.

Lumbar Support (7.5.3)

The height and shape of the lumbar should coincide with the lumbar curve ("the small") of the user's back. The support should be firm, but not cause localized pressure points.

Movements of the Seat Pan and Back Support (7.6)

The user should be able to sit in a position where the torso-to-thigh angle is equal to or greater than 90°. The seat and backrest angles should accommodate the varying postures assumed by the user throughout the day.

Arm Support (7.7)

Armrest Height (7.7.1)

This should allow users to sit in a variety of postures while supporting their forearms and/or elbows in a manner that avoids lifting the shoulders (armrests too high) or leaning to the side to reach the armrest (armrests too low). The armrest height should allow accessibility to, and performance of, tasks.

Armrest Length (7.7.2)

The length of the armrest should allow users to sit close enough to the work surface to perform their tasks while maintaining contact with the backrest.

Inside Distance Between Armrests (7.7.3)

Armrests should allow users to sit in a variety of postures while supporting their forearms in a manner that avoids lifting the shoulders and/or excessive outward positioning of the elbows. Armrests should allow accessibility to, and performance of, tasks. The inside distance between the armrests should allow the user to enter and exit the chair easily. The hips should comfortably fit between the armrests or supports.

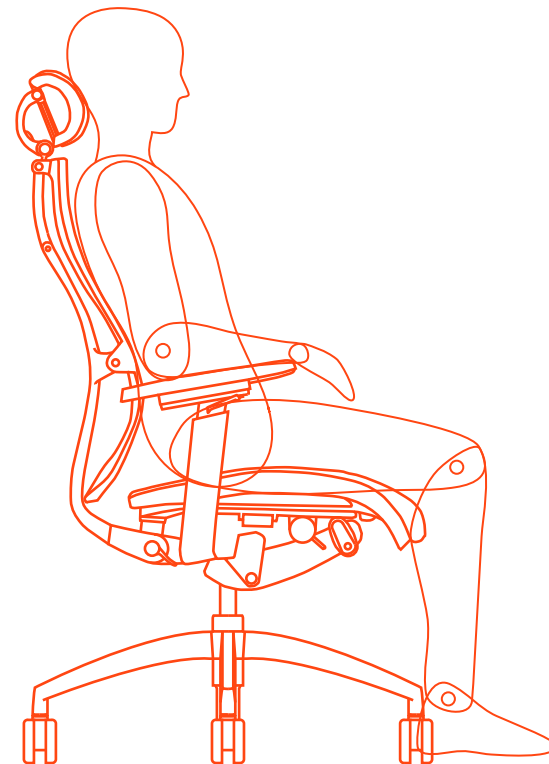

care and maintenance

- Insure the gas cylinder is inserted into the control firmly. Improper connection may cause wobbling.
- Choose correct casters for different floor surfaces. We suggest choosing hard floor casters for tile or concrete surfaces.
- For drafting stool use, we recommend self-locking casters for hard floors. See Caster Selection Guide for more details.
- Do not stand on footring
- Do not sit on any part of the chair except the seat; Do not sit on arms or backrest
- To avoid chair collapse do not remove knobs or screws.
- Properly dispose of packing materials. Do not use plastic as head covering. It may cause suffocation.
- If any parts are missing, broken, damaged or worn, do not use the chair until repairs are made using factory-authorized parts.
- Do not attempt to make any alterations to chair.
- Do not use chair on uneven floor surfaces.
- Do not drape coats or sweaters on back of chairs with casters. Hanging fabric may suddenly stop casters from rolling.
- Do not use excessive speed when moving the chair with casters while seated.
- Do not over exert the functions of a chair which are only to be used under normal conditions
- Do not stand on and/or use this chair as a stepladder. Use this product only for seating one person at a time
- Do not use this chair unless all bolts, screws and knobs are firmly secured

Check the following at 4 month intervals

- All exposed fasteners should be checked and any loose fasteners tightened. Use appropriate tools. Replace any fasteners that appear to be damaged in any way
- The chair mechanism should be checked for any looseness, excessive wear or signs of damage. Immediately remove the chair from service if any damage or failure is found.
- The base and casters should be checked for any signs of excessive wear for failure. Immediately replace any parts that show such wear or failure.

notes



notes



9to5[®]

s e a t i n g



Freight Minimums

- Free freight on all orders of 5 or more chairs
- \$15 per chair for all orders of 4 chairs or less

Sophie Series Chairs:

\$100 per shipment for Sophie orders of 3 chair model units or less

www.9to5seating.com | 310.220.2500

3211 Jack Northrop Avenue, Hawthorne, CA 90250